



FILTROS

partmo

60 años

CATÁLOGO DE PRODUCTOS

Edición 1 - Año 2023
CIAL-GU-02 8/31/2023

Por qué



ES JUSTO
LO QUE NECESITAS



1 MANUFACTURA DE PRIMER NIVEL

Invertimos en procesos tecnológicos para entregar el mejor filtro garantizando la calidad de los mismos.

3 PORTAFOLIO DE PRODUCTOS

Énfasis en motores Diésel, con una amplia cobertura en las principales aplicaciones (Medianas/Pesadas) de transporte de carga y pasajeros.

5 HERRAMIENTAS ONLINE

La plataforma mas completa para cruces de referencia y búsqueda de filtros por marca, modelo y motor de acuerdo a las necesidades de nuestros clientes: catalog.partmo.com

7 PROGRAMA DE CRECIMIENTO

Aumentar las recomendaciones y personas influyentes de la marca

9 SOPORTE COMERCIAL

Identificación de punto de venta y materiales publicitarios

2 CAPACIDAD DE DISEÑO Y DESARROLLO

Soporte de Donaldson en innovación y desarrollo para nuevos productos y rediseño de actuales para satisfacer las necesidades de los diferentes mercados.

4 CAPACITACIONES

Capacitaciones en campo y disponibilidad de la mejor plataforma e-learning de entrenamiento denominada Universidad Partmo: www.universidad.partmo.com

6 ENTRENAMIENTO APOYO A LAS VENTAS

Educación virtual en nuestra Clínica de ventas dentro de Universidad Partmo

8 SOPORTE TÉCNICO Y COMERCIAL

Ingeniero de Soporte de ventas en campo y acompañamiento comercial con nuestros distribuidores. Garantía y respaldo a su alcance.

10 MAYOR RENTABILIDAD

Los representantes de la marca Partmo tiene la posibilidad de hacer dinero y hacer crecer su negocio.

SOLUCIONES EN FILTRACIÓN PARA TRANSPORTE MEDIANO

www.partmo.com

Encuétranos como **Filtros Partmo** [f](#) / [@](#) / [in](#) / [v](#)

Servicio al Cliente:
[☎](#) (+57) 317 645 6045 - 01 8000 978 203



CO-SC-CER896120

CONTENIDO

CATÁLOGO DE PRODUCTOS 2020

Partmo 60 Años	4
Instrucciones de uso	12
Carta de presentación	13

GUÍA DE PRODUCTO

Filtros de Aire para motor	14
Filtros para Aceite	51
Filtros de Combustible	78
Filtros de Separador agua combustible	91
Filtros de Refrigerante	102
Filtros de Aire Cabina	106
Otros Filtros	114
Kits Partmo	116

GUÍAS DE FILTRACIÓN

HD / Pesado	122
MD / Mediano	134
LDD / Liviano Diésel	144
LD / Liviano	153
Hibridos	183
Otros	184

KITS DE FILTRACIÓN

HD / Pesado	189
MD / Mediano	224
LDD / Liviano Diésel	258

CRUCE DE REFERENCIAS

Cruce de referencias	275
----------------------------	-----

CARTA DE GARANTÍA

Carta de Garantía	353
-------------------------	-----

Nota de interés

La información contenida en este catálogo se puede utilizar como guía parcial. La responsabilidad final de la instalación, aplicación y montaje de los filtros es directa responsabilidad del lubricador. Filtros Partmo no asume la responsabilidad de un uso incorrecto de las aplicaciones.

Al mencionar las marcas comerciales de los vehículos, son usadas únicamente como referencia y no las vinculan directamente con Filtros Partmo.



FILTROS
partmo

60 años



Esta es nuestra historia

1962

1974





FILTROS Partmo

1974

1981

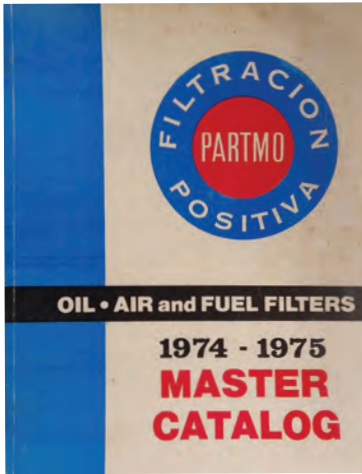



FILTROS Partmo

1985

1992

1997





FILTROS Partmo



FILTROS Partmo

2000



2003

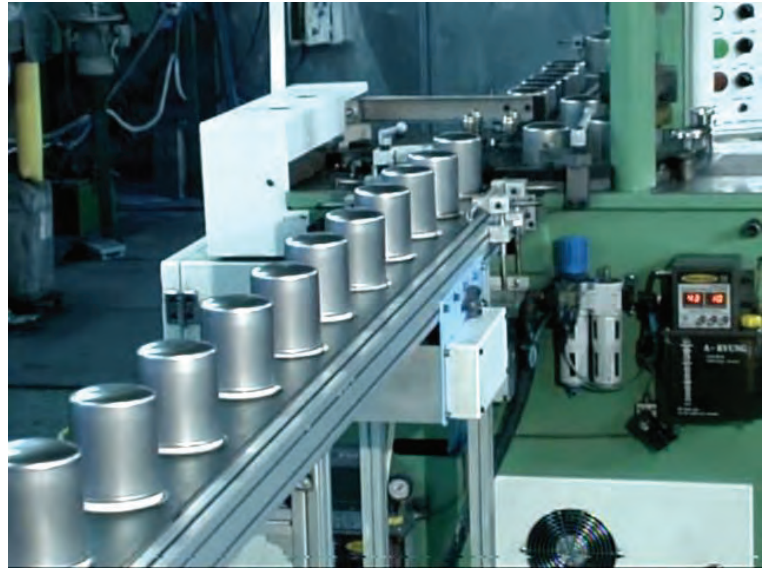

2005

2006

2010



2011

2016



2018

2020

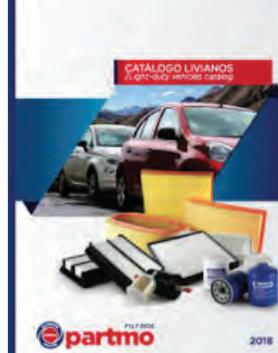

INSTRUCCIONES DE USO

ICONOS

Identifique el tipo de filtro que está buscando por medio de los siguiente iconos,



AIRE



ACEITE



COMBUSTIBLE



SEPARADOR AGUA
COMBUSTIBLE



REFRIGERANTE

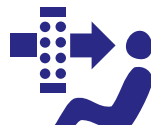

AIRE CABINA



HIDRÁULICO



TRANSMISIÓN



SECADOR DE AIRE

Capítulo 1 - Guía de Producto

En esta sección encontrará los Tips de Instalación del tipo de filtro y la referencia de imagen - producto de nuestro portafolio, con sus características físicas y una referencia visual del mismo.

Todos los filtros están organizados alfanuméricamente.

Capítulo 2 - Guías de Filtración

En esta sección encontrará las Guías de Filtración, las marcas están ordenados alfabéticamente, por atributos de los productos, organizada por tipo y por el segmento del vehículo:

- * Liviano (LD)
- * Liviano Diésel (LDD)
- * Mediano (MD)
- * Pesado (HD)

Capítulo 3 - Kits de aplicaciones

En esta sección encontrará Kit de aplicaciones principales con la imagen de algunos de los vehículos más representativos del mercado colombiano, con las aplicaciones de filtros de acuerdo al vehículo, modelo y motor.

Capítulo 4 - Cruce de referencias

En esta sección encontrará el Cruce de Referencias de los productos equivalentes de Filtros Partmo vs. otras marcas. Una vez identifique la referencia/marca que está buscando, encuentre el equivalente.

Todas las referencias de producto están organizadas alfanuméricamente.

Abreviaturas

LD - Light Duty
LDD - Light Duty Diesel
MD - Medium Duty
HD - Heavy Duty

D. - Diámetro
V. - Válvula
Diámetro (E/S) - Entrada / Salida
AC - Aire Cabina

SF - Secador de Frenos

FILTROS PARTMO, UN LEGADO QUE CONTINÚA RECORRIENDO LAS AUTOPISTAS DE LATINOAMÉRICA



En 1962 Inicia una gran historia donde en el momento contaban con 8 máquinas y un equipo de trabajo conformado por 8 hombres que trabajaron con imparable entusiasmo al lado de Álvaro Duarte Mora para construir un gran proyecto entre los años 70's y 80's. En los 90's con el desarrollo de nuevas líneas de producción con nuevas y más amplias instalaciones se consolida como el líder en el mercado con un plan de inversión y mejora continua de nuestros procesos.

Para el año 2001, Industrias Partmo logro ser la primera empresa de filtros en Colombia en certificar su sistema de gestión de calidad. En este mismo año se inaugura una nueva planta en Bucaramanga con lo cual cubre el mercado nacional e internacional.

En septiembre de 2016, Filtros Partmo da un gran paso al convertirse en parte de un grande de la filtración mundial pues es adquirido por Donaldson Company, aumentando su respaldo y cobertura nivel nacional e internacional, robusteciendo el portafolio de productos y la generación de capacidades de manufactura de soluciones en filtración en Sudamérica.

Hoy somos el mejor proveedor de filtración con la mejor relación costo/beneficio para motores diésel de transporte de carga y pasajeros. Tenemos una excelente oferta de mercado con énfasis en el segmento médium duty; asegurando una alta cobertura de productos en plataformas asiáticas y americanas.

Contamos con una capacidad de manufactura de primer nivel que permite atender las necesidades de los clientes en el continente americano ¡Nuestra trayectoria y experiencia, se proyectan para ofrecer la solución de filtración que requiere el mercado!

Por más de 60 años hemos construido una marca con poder, siempre teniendo claro que nuestros usuarios merecen lo mejor, ofreciendo las mejores soluciones de filtración, con productos que cumplen con altos estándares tecnológicos y de calidad siempre enfocados en nuestros usuarios finales con el apoyo de nuestra red de distribuidores a nivel nacional e internacional.

La innovación, compromiso, respeto e integridad son los valores con los que continuaremos trabajando, buscando mayores y mejores resultados donde el esfuerzo, la dedicación, la perseverancia, el talento, el trabajo en equipo, el amor y la pasión por lo que hacemos son parte de nuestra esencia.

Hoy damos las gracias a todas las personas que han hecho parte de esta gran familia, porque juntos hemos construido este gran proyecto teniendo claro que siempre vamos por más, seguiremos creciendo, proyectándonos. fortaleciéndonos, evolucionando incansablemente porque somos una marca orgullosamente colombiana con gran proyección en América Latina.

Partmo, es justo lo que necesita.



ES JUSTO
LO QUE NECESITAS



**SOLUCIONES EN FILTRACIÓN
PARA TRANSPORTE MEDIANO**

Encuétranos como
Filtros Partmo / f / @ / in / v /

partmo.com



CO-SC-CER86120

TIPS DE INSTALACIÓN

Selección de purificador

Partmo cuenta con una gran variedad de filtros de aire para motores diésel que se encuentran disponibles en los diferentes mercados latinoamericanos. ¿Cómo seleccionar el modelo adecuado que proteja correctamente el motor? En el momento de seleccionar el filtro correcto se deben tener en cuenta los siguientes factores:

1. Referencia de equipo original
2. Flujo de aire del motor
3. Entorno en el que funcionará el equipo.

Más adelante se explicaran algunos pasos para elegir correctamente el filtro que se requiere para una determinada aplicación.

Referencia Original de Equipo Original para el Filtro que se requiere

Lo ideal es tener la referencia original del filtro para poder encontrar su equivalente en Partmo. No es recomendable hacerlo a partir de un número de remplazo (After Market) pues se podría estar haciendo un cruce de referencia a partir de algún error o una referencia que no haya sido cruzada correctamente. Realice esta actividad a través de nuestra página web catalogo.partmo.com. Si tiene dudas por favor comuníquese con nuestro ingeniero de campo que en breve recibirá respuesta.

Requerimientos del Motor

Para obtener especificaciones más precisas del flujo de aire del motor, se recomienda el uso de la tasa de flujo de aire especificada por el fabricante del motor. Si esta información no está disponible, puede calcular sus propios números mediante el uso de algunos métodos que se muestran a continuación. Si el filtro de aire tiene una vibración excesiva por causa del motor, incluya un factor de vibración en sus cálculos.

Método Recomendado Fórmula para motores de 4 tiempos

Sistema Ingles:
Flujo de aire en (CFM) = (tamaño del motor (CID) x RPM) x VE/3456

Sistema Métrico:
Flujo de aire en (m³/min) = (tamaño del motor (litros) x RPM) x VE/2000

VE = Eficiencia Volumétrica para motores de 4 tiempos*
0,90 para motores a gas natural
0,90 para motores a diésel
1,60 para motores diésel turbo cargados
1,85 para motores diésel turbo cargados después del enfriamiento

Fórmula de motor de 2 tiempos (ciclo)

Sistema Ingles:
Flujo de aire (CFM) = (Tamaño del motor (CID) x RPM) x VE / 1728

Sistema métrico
Flujo de aire (m³/min) = (tamaño del motor (litros) x RPM) x VE/1000

VE = Eficiencia volumétrica para motores de 2 tiempos*
0,90 para motores a gas natural
1,40 para motores diésel con soplador de aire
1,85 para motor diésel turbo cargados

Método Alternativo

Sistema Ingles:
Flujo de aire (CFM) = HP (SAE) x SA
SA = (flujo de aire específico) por caballo de fuerza

En motores a 4 tiempos:
Motor diésel: 2,0
Motor diésel turbo cargado: 2,3
Motor diésel turbo cargados después de enfriamiento: 2,3

En Motores de 2 tiempos:
Motor diésel: 2,0
Motor diésel con soplador de aire: 3,3
Motor diésel turbo cargados: 3,6

Sistema Métrico:
Flujo de aire (m³/min) = HP (SAE) x SA
SA = (flujo de aire específico) por caballo de fuerza

En motores a 4 tiempos:
Motor diésel: 0.057
Motor diésel turbo cargado: 0.0065
Motor diésel turbo cargados después de enfriamiento: 0.065

En Motores de 2 tiempos:
Motor diésel: 0.057
Motor diésel con soplador de aire: 0.093
Motor diésel turbo cargados: 0.102

El factor de Vibración o Pulsación (PF)

Para obtener especificaciones más precisas del flujo de aire del motor, se recomienda el uso de la tasa de flujo de aire especificada por el fabricante del motor. Puede obtener esta información del fabricante.

Sistema Ingles:
 2,1 para 1 cilindro
 1,5 para 2 cilindros
 1,2 para 3 cilindros
 1,0 para 4 cilindros.

Sistema Métrico
 1,2 m3/min

Los valores de VE son guías. Siempre es mejor usar las especificaciones del fabricante del motor si están disponibles. Los controles electrónicos de los motores modernos pueden tener relaciones de VE de 2,0 o más.

Evalúe el nivel de polvo y contaminantes al cual está expuesto el motor en sus condiciones normales de operación.

Es importante evaluar el nivel de polvo y contaminantes al cual está expuesto el motor pues esto determinara la vida útil del filtro. Por ejemplo, un motor estacionario de un generador de un edificio probablemente tendrá estar expuesto a bajos niveles de polvo y contaminantes por lo

cual el filtro de aire debería tener una duración mayor en comparación a un motor de un vehículo que se encuentre operando en una cantera rodeado de una alta concentración de polvo. Es importante tener en cuenta la dirección del flujo y la carcasa en la cual estará instalado el filtro, esta puede ser de un o dos etapas de acuerdo a la arquitectura del motor y las condiciones de operación del equipo.

Seleccione la familia de filtros de aire correctos para una determinada aplicación.

Para ubicar la opción correcta para un filtro de aire acuerdo con las cfm que su motor necesita se debe consultar la tabla Restricción de flujo de aire inicial para el estilo de carcasa que este considerando. Existen varios tipos de filtros de aire entre los cuales están: de Sello Radial, de Sello Axial y PowerCore. Para cada aplicación se deben tener en cuenta, las dimensiones, las ubicaciones de la entrada y la salida, y las configuraciones de montaje. Estos parámetros a veces son críticos y pueden llevarlo a un modelo o un filtro alternativo que se adapte mejor a las condiciones de normales de operación del motor.

Filtros de flujo estándar y flujo inverso

Estos filtros se ven exactamente iguales excepto por las líneas oscuras que se ven en la media filtrante de los filtros. ¿Cuál es la diferencia? Uno es un filtro de flujo estándar, el otro es de flujo inverso. Aunque esto filtros sean aparentemente iguales y calcen perfectamente en las carcasas donde se alojan, no pueden ser intercambiables pues tienen especificaciones de flujo totalmente diferentes.

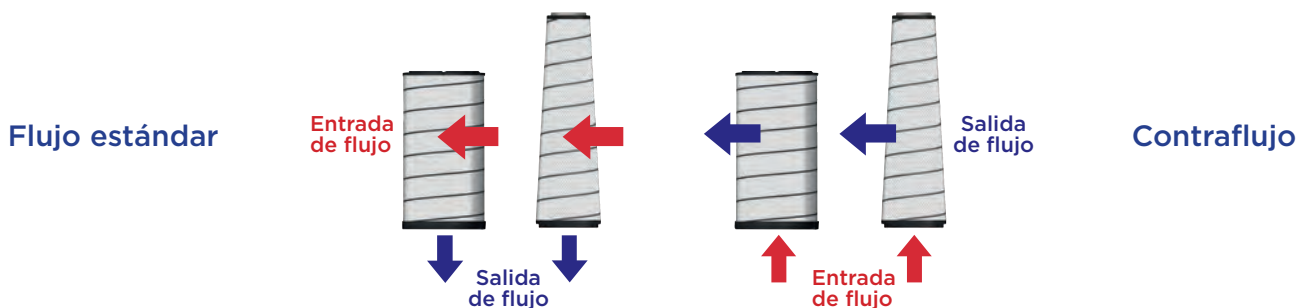

Tipos de Carcasas:

Existen diferentes tipos de carcasa donde se alojan los filtros de aire dependiendo del tipo de flujo y del tipo de sello del filtro. A continuación presentamos algunos ejemplos:

a. Carcasa de Sello Radial de una etapa y flujo inverso utilizada normalmente para condiciones de baja contaminación y polvo ligero:

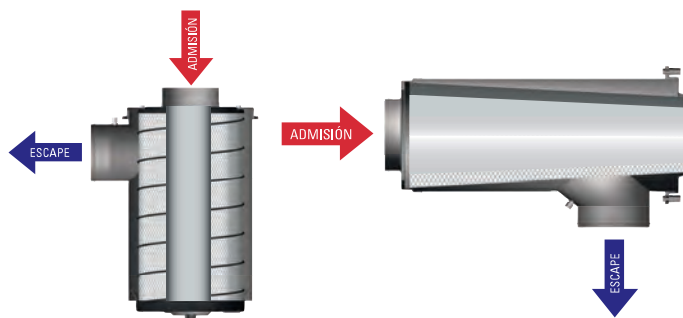

b. Carcasa de sello radial de una etapa y flujo estándar utilizada normalmente para condiciones medias de contaminación y polvo ligero:

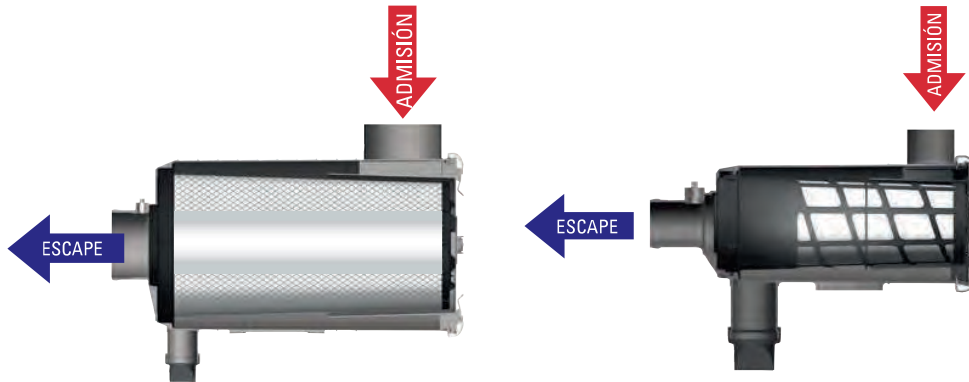

c. Carcasas de dos etapas con sello radial para flujo estándar utilizados para niveles medios de contaminación y polvo pesado:

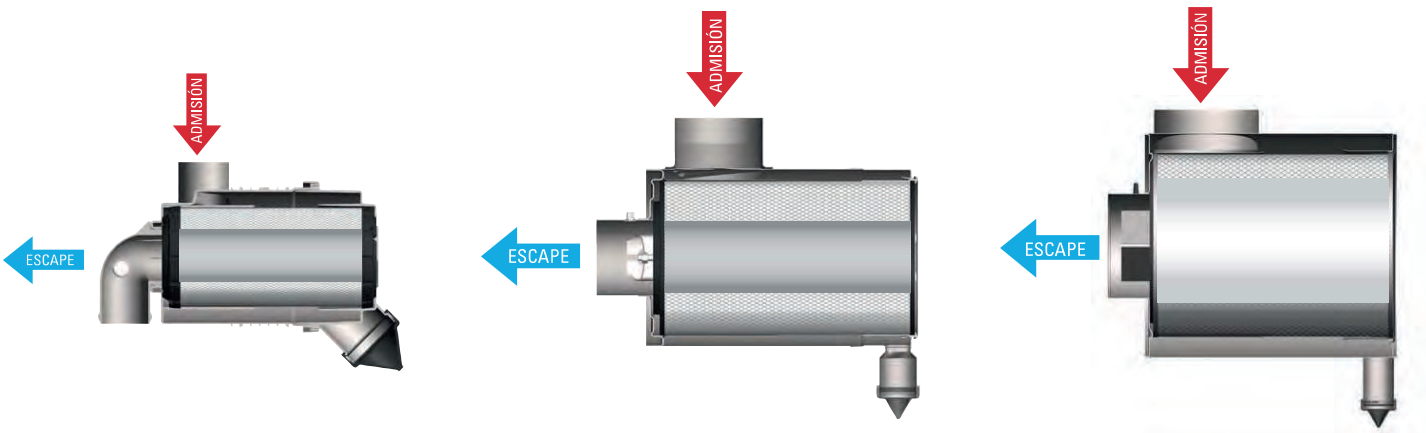

d. Carcasas de dos etapas para filtros de sello radial utilizados para ambientes severos de contaminación y polvo pesado. Podemos encontrar este tipo de filtros en aplicaciones muy especializadas de minería.

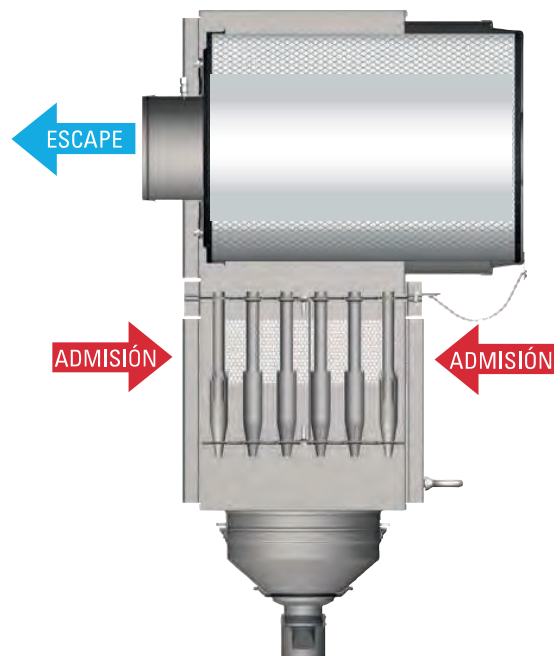



APR9

LD / LIVIANO
AIRE
PRINCIPAL

D. Exterior	237.5 mm
D. Interior	186 mm
Altura	62 mm
D. Montura	0 mm
Tipo	Aire Redondo
Sello	Axial

APLICACIONES
RENAULT

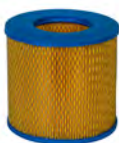

AP05113

LD / LIVIANO
AIRE
PRINCIPAL

D. Exterior	157 mm
D. Interior	76 mm
Altura	145 mm
D. Montaje	0 mm
Tipo	Aire Redondo
Sello	Axial

APLICACIONES
TOYOTA / SKODA



AP0590E

LD / LIVIANO
AIRE
PRINCIPAL

D. Exterior	153 mm
D. Interior	88.1 mm
Altura	210.5 mm
D. Montaje	13.5 mm
Tipo	Aire Redondo
Sello	Axial

APLICACIONES
DAIHATSU



AP0978

LD / LIVIANO
AIRE
PRINCIPAL

Altura	93 mm
Ancho	210 mm
Ancho 2	154 mm
Longitud	300 mm
Longitud 2	244 mm
-	-

APLICACIONES
RENAULT / DACIA



AP1000

LD / LIVIANO
AIRE
PRINCIPAL

Altura	46 mm
Ancho	128 mm
Ancho 2	0 mm
Longitud	258 mm
Longitud 2	0 mm
-	-

APLICACIONES
HYUNDAI



AP101222K

LDD / LIVIANO DIÉSEL
AIRE
PRINCIPAL

D. Exterior	132 mm
D. Interior	71 mm
Altura	292 mm
D. Montaje	16 mm
Tipo	Aire Redondo
Sello	Axial

APLICACIONES
HYUNDAI / NISSAN / BOBCAT
NEW HOLLAND



AP101234K

OTROS
AIRE
PRINCIPAL

D. Exterior	202 mm
D. Interior	90 mm
Altura	259 mm
D. Montaje	13 mm
Tipo	Aire Redondo
Sello	Axial

APLICACIONES
ALLIS CHALMERS / JOHN DEERE
HITACHI



AP101246K

OTROS
AIRE
PRINCIPAL

D. Exterior	153 mm
D. Interior	88 mm
Altura	310 mm
D. Montaje	18 mm
Tipo	Aire Redondo
Sello	Axial

APLICACIONES
ALLIS-CHALMERS / BOBCAT / CASE
CATERPILLAR / JCB / JOHN DEERE



AP101275K

OTROS
AIRE
PRINCIPAL

D. Exterior	103 mm
D. Interior	64 mm
Altura	259 mm
D. Montaje	18 mm
Tipo	Aire Redondo
Sello	Axial

APLICACIONES
ALLIS-CHALMERS / BOBCAT / CASE
HITACHI / JOHN DEERE / KOMATSU



AP106775

HD / PESADO
AIRE
SECUNDARIO

D. Exterior	159.5 mm
D. Interior	133 mm
Altura	404 mm
D. Montaje	16.5 mm
Tipo	Aire Redondo
Sello	Axial

APLICACIONES
CHEVROLET / CATERPILLAR / JCB
KOMATSU / MASSEY FERGUSON



AP1087

LD / LIVIANO
AIRE
PRINCIPAL

Altura	65 mm
Ancho	135 mm
Ancho 2	0 mm
Longitud	325 mm
Longitud 2	0 mm
-	-

APLICACIONES
RENAULT



AP10903

OTROS
AIRE
PRINCIPAL

D. Exterior	138 mm
D. Interior	82 mm
Altura	276 mm
D. Montaje	0 mm
Tipo	Aire Redondo
Sello	Radial

APLICACIONES
MONTACARGAS TOYOTA



AP110558
HD / PESADO
AIRE
PRINCIPAL

D. Exterior	276 mm
D. Interior	173 mm
Altura	417 mm
D. Montaje	16.9 mm
Tipo	Aire Redondo
Sello	Axial

APLICACIONES
 CHEVROLET / ALLIS-CHALMERS
 HITACHI / IVECO / JCB



AP1126
HD / PESADO
AIRE
PRINCIPAL

D. Exterior	223 mm
D. Interior	183 mm
Altura	382 mm
D. Montaje	0 mm
Tipo	Aire Redondo
Sello	Radial

APLICACIONES
 FOTON AUMARK



AP1126SY
HD / PESADO
AIRE
PRINCIPAL

D. Exterior	181 mm
D. Interior	96 mm
Altura	363 mm
D. Menor	121 mm
Tipo	Aire Redondo
Sello	Radial

APLICACIONES
 FOTON AUMARK



AP1130E
LDD / LIVIANO DIÉSEL
AIRE
PRINCIPAL

D. Exterior	211 mm
D. Interior	133 mm
Altura	149 mm
D. Montaje	0 mm
Tipo	Aire Redondo
Sello	Axial

APLICACIONES
 ASIA



AP114215145
HD / PESADO
AIRE
SECUNDARIO

D. Exterior	144 mm
D. Interior	116 mm
Altura	317 mm
D. Montaje	17 mm
Tipo	Aire Redondo
Sello	Axial

APLICACIONES
 CHEVROLET/CLARK/ELGIN/HINO
 HITACHI/NISSAN/TIMBERJACK



AP117797
HD / PESADO
AIRE
PRINCIPAL

Flujo invertido

D. Exterior	263 mm
D. Interior	154 mm
Altura	578 mm
D. Montaje	0 mm
Tipo	Aire Redondo
Sello	Axial

APLICACIONES
 KENWORTH / MACK / PETERBILT



AP1202
LD / LIVIANO
AIRE
PRINCIPAL

Altura	36 mm
Ancho	185 mm
Ancho 2	0 mm
Longitud	303 mm
Longitud 2	0 mm
-	-

APLICACIONES
 ZOTIE



AP126
LD / LIVIANO
AIRE
PRINCIPAL

D. Exterior	254 mm
D. Interior	201 mm
Altura	71 mm
D. Montaje	0 mm
Tipo	Aire Redondo
Sello	Axial

APLICACIONES
 CHEVROLET



AP1271
LD / LIVIANO
AIRE
PRINCIPAL

Altura	40 mm
Ancho	245 mm
Ancho 2	0 mm
Longitud	179 mm
Longitud 2	0 mm
-	-

APLICACIONES
 FIAT / ALFA ROMEO



AP1275
LD / LIVIANO
AIRE
PRINCIPAL

Altura	36 mm
Ancho	195 mm
Ancho 2	0 mm
Longitud	245 mm
Longitud 2	0 mm
-	-

APLICACIONES
 FIAT



AP1298
LD / LIVIANO
AIRE
PRINCIPAL

Altura	37 mm
Ancho	165 mm
Ancho 2	0 mm
Longitud	212 mm
Longitud 2	0 mm
-	-

APLICACIONES
 CHEVROLET



AP1305
LD / LIVIANO
AIRE
PRINCIPAL

Altura	42 mm
Ancho	147 mm
Ancho 2	0 mm
Longitud	324 mm
Longitud 2	0 mm
-	-

APLICACIONES
 FORD



AP1312
LD / LIVIANO
AIRE
PRINCIPAL

Altura	35 mm
Ancho	166 mm
Ancho 2	0 mm
Longitud	276 mm
Longitud 2	0 mm
-	-

APLICACIONES
NISSAN / SUBARU / SUZUKI



AP13190
HD / PESADO
AIRE
PRINCIPAL

D. Exterior	298 mm
D. Interior	190 mm
Altura	371 mm
D. Montaje	24 mm
Tipo	Aire Redondo
Sello	Axial

APLICACIONES
HINO



AP13190SY
HD / PESADO
AIRE
SECUNDARIO

D. Exterior	186 mm
D. Interior	156 mm
Altura	337 mm
D. Montaje	16 mm
Tipo	Aire Redondo
Sello	Axial

APLICACIONES
HINO



AP1323
LD / LIVIANO
AIRE
PRINCIPAL

Altura	41 mm
Ancho	169 mm
Ancho 2	0 mm
Longitud	344 mm
Longitud 2	0 mm
-	-

APLICACIONES
DODGE / JEEP



AP1325
MD / MEDIANO
AIRE
PRINCIPAL

D. Exterior	232 mm
D. Interior	123 mm
Altura	437 mm
D. Montaje	0 mm
Tipo	Aire Redondo
Sello	Radial

APLICACIONES
HINO



AP1330E
MD / MEDIANO
AIRE
SECUNDARIO

D. Exterior	108 mm
D. Interior	83 mm
Altura	411 mm
D. Montaje	0 mm
Tipo	Aire Redondo
Sello	Radial

APLICACIONES
HINO



AP1347
LD / LIVIANO
AIRE
PRINCIPAL

Altura	42 mm
Ancho	210 mm
Ancho 2	0 mm
Longitud	246 mm
Longitud 2	0 mm
-	-

APLICACIONES
DAEWOO / HYUNDAI



AP1360
LD / LIVIANO
AIRE
PRINCIPAL

Altura	47 mm
Ancho	148 mm
Ancho 2	0 mm
Longitud	246 mm
Longitud 2	0 mm
-	-

APLICACIONES
HYUNDAI



AP1375
LD / LIVIANO
AIRE
PRINCIPAL

Altura	39 mm
Ancho	160 mm
Ancho 2	0 mm
Longitud	247 mm
Longitud 2	0 mm
-	-

APLICACIONES
HYUNDAI



AP137640
HD / PESADO
AIRE
SECUNDARIO

D. Exterior	150 mm
D. Interior	122 mm
Altura	354 mm
D. Montaje	16 mm
Tipo	Aire Redondo
Sello	Axial

APLICACIONES
DINA / INTERNACIONAL
NAVISTAR / AG CHEM EQUIPMENT



AP14210
HD / PESADO
AIRE
PRINCIPAL

D. Exterior	232 mm
D. Interior	132 mm
Altura	370 mm
D. Montaje	0 mm
Tipo	Aire Redondo
Sello	Radial

APLICACIONES
CHEVROLET / HITACHI / ISUZU,
JOHN DEERE / KOBELCO / NISSAN



AP14220
HD / PESADO
AIRE
SECUNDARIO

D. Exterior	132 mm
D. Interior	95 mm
Altura	350 mm
D. Montaje	0 mm
Tipo	Aire Redondo
Sello	Radial

APLICACIONES
CHEVROLET



AP16550
LDD / LIVIANO DIÉSEL
AIRE
PRINCIPAL

D. Exterior	168 mm
D. Interior	80 mm
Altura	144 mm
D. Montaje	0 mm
Tipo	Aire Redondo
Sello	Radial

APLICACIONES
CHEVROLET / ISUZU



AP17308
MD / MEDIANO
AIRE
PRINCIPAL

D. Exterior	167.1 mm
D. Interior	109.8 mm
Altura	384.3 mm
D. Montaje	17.5 mm
Tipo	Aire Redondo
Sello	Axial

APLICACIONES
FORD / MERCEDES BENZ
VOLKSWAGEN



AP17845
HD / PESADO
AIRE
PRINCIPAL

D. Exterior	280 mm
D. Interior	175 mm
Altura	374 mm
D. Montaje	0 mm
Tipo	Aire Redondo
Sello	Radial

APLICACIONES
HINO / NISSAN



AP17846
HD / PESADO
AIRE
SECUNDARIO

D. Exterior	174 mm
D. Interior	130 mm
Altura	355 mm
D. Montaje	0 mm
Tipo	Aire Redondo
Sello	Radial

APLICACIONES
HINO / NISSAN



AP17871
MD / MEDIANO
AIRE
PRINCIPAL

D. Exterior	216 mm
D. Interior	123 mm
Altura	342 mm
D. Montaje	0 mm
Tipo	Aire Redondo
Sello	Radial

APLICACIONES
HINO



AP17871SY
MD / MEDIANO
AIRE
SECUNDARIO

D. Exterior	106 mm
D. Interior	82 mm
Altura	331 mm
D. Montaje	0 mm
Tipo	Aire Redondo
Sello	Radial

APLICACIONES
HINO



AP182028
HD / PESADO
AIRE
PRIMARIO

D. Exterior	263.5 mm
D. Interior	154.5 mm
Altura	415.5 mm
D. Montaje	0 mm
Tipo	Aire Redondo
Sello	Axial

APLICACIONES
DINA / INTERNATIONAL



AP186
LD / LIVIANO
AIRE
PRINCIPAL

D. Exterior	220 mm
D. Interior	115 mm
Altura	125 mm
D. Montaje	0 mm
Tipo	Aire Redondo
Sello	Axial

APLICACIONES
TOYOTA



AP1861
LD / LIVIANO
AIRE
PRINCIPAL

D. Exterior	220 mm
D. Interior	115 mm
Altura	146 mm
D. Montaje	0 mm
Tipo	Aire Redondo
Sello	Axial

APLICACIONES
TOYOTA



AP1908233
LDD / LIVIANO DIÉSEL
AIRE
PRINCIPAL

D. Exterior	154 mm
D. Interior	84 mm
Altura	345.2 mm
D. Montaje	0 mm
Tipo	Aire Redondo
Sello	Radial

APLICACIONES
IVECO



AP2021
LD / LIVIANO
AIRE
PRINCIPAL

Altura	54 mm
Ancho	184 mm
Ancho 2	0 mm
Longitud	278 mm
Longitud 2	0 mm
-	-

APLICACIONES
VOLKSWAGEN / SKODA



AP203823
MD / MEDIANO
AIRE
PRINCIPAL

D. Exterior	197 mm
D. Interior	115.7 mm
Altura	371 mm
D. Montaje	0 mm
Tipo	Aire Redondo
Sello	Radial

APLICACIONES
FOTON



AP20457

**MD / MEDIANO
AIRE
PRINCIPAL**

D. Exterior	200 mm
D. Interior	96 mm
Altura	382.5 mm
D. Montaje	0 mm
Tipo	Aire Redondo
Sello	Radial

**APLICACIONES
MERCEDES BENZ**



AP21413

**MD / MEDIANO
AIRE
PRINCIPAL**

D. Exterior	200 mm
D. Interior	107 mm
Altura	261 mm
D. Montaje	0 mm
Tipo	Aire Redondo
Sello	Radial

**APLICACIONES
CHEVROLET**



AP2205

**MD / MEDIANO
AIRE
PRINCIPAL**

D. Exterior	228.5 mm
D. Interior	115.9 mm
Altura	275.5 mm
D. Montaje	10.2 mm
Tipo	Aire Redondo
Sello	Axial

**APLICACIONES
FOTON / JAC**



AP2206

**MD / MEDIANO
AIRE
PRINCIPAL**

D. Exterior	198 mm
D. Interior	109 mm
Altura	293 mm
D. Montaje	10 mm
Tipo	Aire Redondo
Sello	Axial

**APLICACIONES
FOTON**



AP2211

**HD / PESADO
AIRE
PRINCIPAL**

D. Exterior	298.4 mm
D. Interior	190.8 mm
Altura	390 mm
D. Montaje	24.5 mm
Tipo	Aire Redondo
Sello	Axial

**APLICACIONES
HYUNDAI / JAC**



AP2216

**HD / PESADO
AIRE
PRINCIPAL**

D. Exterior	277 mm
D. Interior	171 mm
Altura	515 mm
D. Montaje	24.2 mm
Tipo	Aire Redondo
Sello	Axial

**APLICACIONES
FOTON / YUTONG**



AP2217

**LDD / LIVIANO DIÉSEL
AIRE
PRINCIPAL**

D. Exterior	132.5 mm
D. Interior	84.6 mm
Altura	284 mm
D. Montaje	18 mm
Tipo	Aire Redondo
Sello	Axial

**APLICACIONES
FOTON / GOLDEN DRAGON
JIMBEI**



AP2224

**MD / MEDIANO
AIRE
PRINCIPAL**

D. Exterior	224.5 mm
D. Interior	139.2 mm
Altura	248 mm
D. Montaje	19.8 mm
Tipo	Aire Redondo
Sello	Axial

**APLICACIONES
JAC**



AP2231

**MD / MEDIANO
AIRE
PRINCIPAL**

D. Exterior	163 mm
D. Interior	87mm
Altura	269 mm
D. Montaje	0 mm
Tipo	Aire Redondo
Sello	Radial

**APLICACIONES
FOTON**



AP2236

**MD / MEDIANO
AIRE
PRINCIPAL**

D. Exterior	215 mm
D. Interior	115 mm
Altura	264 mm
D. Montaje	0 mm
Tipo	Aire Redondo
Sello	Radial

**APLICACIONES
JAC / WECHAI**



AP2239

**MD / MEDIANO
AIRE
PRINCIPAL**

D. Exterior	197 mm
D. Interior	109 mm
Altura	251 mm
D. Montaje	23 mm
Tipo	Aire Redondo
Sello	Axial

**APLICACIONES
FOTON**



AP2251

**MD / MEDIANO
AIRE
PRINCIPAL**

D. Exterior	220 mm
D. Interior	134 mm
Altura	320.5 mm
D. Montaje	0 mm
Tipo	Aire Redondo
Sello	Radial

**APLICACIONES
FOTON**



AP2252
MD / MEDIANO
AIRE
PRINCIPAL

D. Exterior	197 mm
D. Interior	109 mm
Altura	285 mm
D. Montaje	0 mm
Tipo	Aire Redondo
Sello	Axial

APLICACIONES
FOTON



AP2253
MD / MEDIANO
AIRE
PRINCIPAL

D. Exterior	178 mm
D. Interior	109 mm
Altura	263,5 mm
D. Montaje	0 mm
Tipo	Aire Redondo
Sello	Radial

APLICACIONES
JAC



AP2263
MD / MEDIANO
AIRE
PRINCIPAL

D. Exterior	198 mm
D. Interior	112 mm
Altura	318 mm
D. Montaje	0 mm
Tipo	Aire Redondo
Sello	Radial

APLICACIONES
FOTON



AP2279
MD / MEDIANO
AIRE
PRINCIPAL

D. Exterior	220 mm
D. Interior	108 mm
Altura	161 mm
D. Montaje	0 mm
Tipo	Aire Redondo
Sello	Axial

APLICACIONES
HINO / TOYOTA



AP2291
HD / PESADO
AIRE
PRINCIPAL

D. Exterior	241 mm
D. Interior	133 mm
Altura	493 mm
D. Montaje	14 mm
Tipo	Aire Redondo
Sello	Axial

APLICACIONES
FOTON



AP2299
MD / MEDIANO
AIRE
PRINCIPAL

D. Exterior	194 mm
D. Interior	114 mm
Altura	345 mm
D. Montaje	0 mm
Tipo	Aire Redondo
Sello	Axial

APLICACIONES
FOTON



AP23030
MD / MEDIANO
AIRE
PRINCIPAL

D. Exterior	280 mm
D. Interior	147 mm
Altura	379 mm
D. Montaje	0 mm
Tipo	Aire Redondo
Sello	Radial

APLICACIONES
HINO



AP23030SY
MD / MEDIANO
AIRE
PRINCIPAL

D. Exterior	149 mm
D. Interior	121 mm
Altura	362 mm
D. Montaje	0 mm
Tipo	Aire Redondo
Sello	Radial

APLICACIONES
HINO



AP2360
OTROS
AIRE
PRINCIPAL

D. Exterior	132.5 mm
D. Interior	84.6 mm
Altura	388.5 mm
D. Montaje	18 mm
Tipo	Aire Redondo
Sello	Axial

APLICACIONES
CASE SUPER K



AP23603
LD / LIVIANO
AIRE
PRINCIPAL

D. Exterior	150 mm
D. Interior	85 mm
Altura	255 mm
D. Montaje	0 mm
Tipo	Aire Redondo
Sello	Radial

APLICACIONES
FORD



AP240
LDD / LIVIANO DIÉSEL
AIRE
PRINCIPAL

D. Exterior	214 mm
D. Interior	130 mm
Altura	127 mm
D. Montaje	0 mm
Tipo	Aire Redondo
Sello	Axial

APLICACIONES
KIA



AP2425
HD / PESADO
AIRE
PRINCIPAL

D. Exterior	263.5 mm
D. Interior	154.5 mm
Altura	405 mm
D. Montaje	0 mm
Tipo	Aire Redondo
Sello	Axial

APLICACIONES
FORD / MERCEDES BENZ



AP2482

HD / PESADO
AIRE
PRINCIPAL

Flujo invertido

D. Exterior	224.5 mm
D. Interior	147 mm
Altura	584 mm
D. Montaje	0 mm
Tipo	Aire Redondo
Sello	Axial

APLICACIONES
KENWORTH



AP2489

HD / PESADO
AIRE
SECUNDARIO

D. Exterior	64.4 mm
D. Interior	54 mm
Altura	253.8 mm
D. Montaje	18 mm
Tipo	Aire Redondo
Sello	Axial

APLICACIONES
KENWORTH



AP2510

LD / LIVIANO
AIRE
PRINCIPAL

Altura	28 mm
Ancho	139 mm
Ancho 2	0 mm
Longitud	270 mm
Longitud 2	0 mm
-	-

APLICACIONES
HYUNDAI



AP2520

HD / PESADO
AIRE
PRINCIPAL

D. Exterior	263.5 mm
D. Interior	154.5 mm
Altura	309 mm
D. Montaje	0 mm
Tipo	Aire Redondo
Sello	Axial

APLICACIONES
HINO / NISSAN



AP2520H

HD / PESADO
AIRE
PRINCIPAL

D. Exterior	263.5 mm
D. Interior	154.5 mm
Altura	309 mm
D. Montaje	17.5 mm
Tipo	Aire Redondo
Sello	Axial

APLICACIONES
DODGE / NISSAN



AP2521

HD / LIVIANO
AIRE
SECUNDARIO

D. Exterior	150 mm
D. Interior	122 mm
Altura	273.5 mm
D. Montaje	16 mm
Tipo	Aire Redondo
Sello	Axial

APLICACIONES
DODGE



AP25653

HD / PESADO
AIRE
PRINCIPAL

D. Exterior	280 mm
D. Interior	126 mm
Altura	348 mm
D. Montaje	0 mm
Tipo	Aire Redondo
Sello	Radial

APLICACIONES
MERCEDES BENZ



AP2577

HD / PESADO
AIRE
PRINCIPAL

D. Exterior	304 mm
D. Interior	171.3 mm
Altura	201 mm
D. Montaje	0 mm
Tipo	Aire Redondo
Sello	Axial

APLICACIONES
CHEVROLET

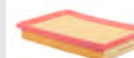

AP2600

LD / LIVIANO
AIRE
PRINCIPAL

Altura	33 mm
Ancho	170 mm
Ancho 2	0 mm
Longitud	245 mm
Longitud 2	0 mm
-	-

APLICACIONES
HYUNDAI



AP2621

HD / PESADO
AIRE
SECUNDARIO

D. Exterior	144 mm
D. Interior	116 mm
Altura	438.5 mm
D. Montaje	17 mm
Tipo	Aire Redondo
Sello	Axial

APLICACIONES
HINO



AP2654

HD / PESADO
AIRE
PRINCIPAL

D. Exterior	332 mm
D. Interior	175 mm
Altura	474.5 mm
D. Montaje	0 mm
Tipo	Aire Redondo
Sello	Radial

APLICACIONES
INTERNATIONAL



AP2654SY

HD / PESADO
AIRE
SECUNDARIO

D. Exterior	173.5 mm
D. Interior	135.6 mm
Altura	446 mm
D. Montaje	0 mm
Tipo	Aire Redondo
Sello	Radial

APLICACIONES
INTERNATIONAL



AP2677

HD / PESADO
AIRE
PRINCIPAL

D. Exterior	220 mm
D. Interior	132 mm
Altura	395 mm
D. Montaje	17 mm
Tipo	Aire Redondo
Sello	Axial

APLICACIONES
MACK / RENAULT



AP2680

HD / PESADO
AIRE
PRINCIPAL

D. Exterior	263.4 mm
D. Interior	172.5 mm
Altura	722 mm
D. Menor	231 mm
Tipo	Aire Redondo
Sello	Axial

APLICACIONES
MACK



AP2688

HD / PESADO
AIRE
PRINCIPAL

D. Exterior	230 mm
D. Interior	149 mm
Altura	467 mm
D. Montaje	25 mm
Tipo	Aire Redondo
Sello	Axial

APLICACIONES
HINO



AP2690

HD / PESADO
AIRE
PRINCIPAL

D. Exterior	232 mm
D. Interior	132 mm
Altura	481 mm
D. Montaje	0 mm
Tipo	Aire Redondo
Sello	Radial

APLICACIONES
FREIGHTLINER



AP2705

HD / PESADO
AIRE
PRINCIPAL

D. Exterior	263.4 mm
D. Interior	172.5 mm
Altura	566 mm
D. Menor	231 mm
Tipo	Aire Redondo
Sello	Axial

APLICACIONES
FREIGHTLINER / KENWORTH



AP2712

MD / MEDIANO
AIRE
PRINCIPAL

D. Exterior	201 mm
D. Interior	130 mm
Altura	265 mm
D. Montaje	19.8 mm
Tipo	Aire Redondo
Sello	Axial

APLICACIONES
CHEVROLET / JAC / NISSAN



AP2712A

MD / MEDIANO
AIRE
PRINCIPAL

D. Exterior	189.7 mm
D. Interior	134.5 mm
Altura	265 mm
D. Montaje	19.8 mm
Tipo	Aire Redondo
Sello	Axial

APLICACIONES
CHEVROLET



AP2712SY

MD / MEDIANO
AIRE
SECUNDARIO

D. Exterior	122 mm
D. Interior	92 mm
Altura	211 mm
D. Montaje	0 mm
Tipo	Aire Redondo
Sello	Axial

APLICACIONES
JAC



AP2741

HD / PESADO
AIRE
PRINCIPAL

D. Exterior	215 mm
D. Interior	135 mm
Altura	387 mm
D. Montaje	10 mm
Tipo	Aire Redondo
Sello	Axial

APLICACIONES
CHEVROLET



AP2761

HD / PESADO
AIRE
PRINCIPAL

D. Exterior	220 mm
D. Interior	134.7 mm
Altura	337 mm
D. Montaje	23.1 mm
Tipo	Aire Redondo
Sello	Axial

APLICACIONES
CHEVROLET



AP2805

OTROS
AIRE
PRINCIPAL

D. Exterior	219 mm
D. Interior	77 mm
Altura	275.5 mm
D. Montaje	0 mm
Tipo	Aire Redondo
Sello	Axial

APLICACIONES
VOLVO



AP2863

HD / PESADO
AIRE
PRINCIPAL

D. Exterior	232 mm
D. Interior	132 mm
Altura	327 mm
D. Montaje	0 mm
Tipo	Aire Redondo
Sello	Radial

APLICACIONES
CHEVROLET / FORD / KENWORTH
INTERNATIONAL



AP2877S

MD / MEDIANO
AIRE
PRINCIPAL

D. Exterior	232 mm
D. Interior	132 mm
Altura	287 mm
D. Montaje	0 mm
Tipo	Aire Redondo
Sello	Radial

APLICACIONES
CHEVROLET / JAC / NISSAN



AP2877SY

MD / MEDIANO
AIRE
SECUNDARIO

D. Exterior	130 mm
D. Interior	101 mm
Altura	270 mm
D. Montaje	0 mm
Tipo	Aire Redondo
Sello	Radial

APLICACIONES
JAC



AP2884

LDD / LIVIANO DIÉSEL
AIRE
PRINCIPAL

D. Exterior	153 mm
D. Interior	88 mm
Altura	161.3 mm
D. Montaje	0 mm
Tipo	Aire Redondo
Sello	Axial

APLICACIONES
CHEVROLET



AP29400

LD / LIVIANO
AIRE
PRINCIPAL

Altura	54.3 mm
Ancho	135 mm
Ancho 2	0 mm
Longitud	265 mm
Longitud 2	0 mm
-	-

APLICACIONES
HYUNDAI / KIA



AP2941

LDD / LIVIANO DIÉSEL
AIRE
PRINCIPAL

D. Exterior	178 mm
D. Interior	112.5 mm
Altura	160.5 mm
D. Montaje	16.3 mm
Tipo	Aire Redondo
Sello	Axial

APLICACIONES
KIA



AP2959

LDD / LIVIANO DIÉSEL
AIRE
PRINCIPAL

D. Exterior	178 mm
D. Interior	109 mm
Altura	246.2 mm
D. Montaje	0 mm
Tipo	Aire Redondo
Sello	Radial

APLICACIONES
KIA



AP2S600

LDD / LIVIANO DIÉSEL
AIRE
PRINCIPAL

D. Exterior	148 mm
D. Interior	61 mm
Altura	185 mm
D. Menor	134.2 mm
Tipo	Aire Redondo
Sello	Radial

APLICACIONES
NISSAN



AP3

LD / LIVIANO
AIRE
PRINCIPAL

D. Exterior	216 mm
D. Interior	146 mm
Altura	74 mm
D. Montaje	0 mm
Tipo	Aire Redondo
Sello	Axial

APLICACIONES
RENAULT



AP30070

LD / LIVIANO
AIRE
PRINCIPAL

Altura	68 mm
Ancho	266 mm
Ancho 2	0 mm
Longitud	215 mm
Longitud 2	0 mm
-	-

APLICACIONES
TOYOTA



AP3101

HD / PESADO
AIRE
PRINCIPAL

Altura	40 mm
Ancho	203 mm
Ancho 2	0 mm
Longitud	237 mm
Longitud 2	0 mm
-	-

APLICACIONES
FORD / MAZDA



AP3102

LD / LIVIANO
AIRE
PRINCIPAL

Altura	38 mm
Ancho	114 mm
Ancho 2	0 mm
Longitud	252 mm
Longitud 2	0 mm
-	-

APLICACIONES
KIA MOTORS



AP3107

LD / LIVIANO
AIRE
PRINCIPAL

Altura	51 mm
Ancho	189 mm
Ancho 2	0 mm
Longitud	270 mm
Longitud 2	0 mm
-	-

APLICACIONES
HYUNDAI



AP3108
LD / LIVIANO
AIRE
PRINCIPAL

Altura	43 mm
Ancho	173 mm
Ancho 2	0 mm
Longitud	253 mm
Longitud 2	0 mm
-	-

APLICACIONES
HYUNDAI / KIA



AP3109
LD / LIVIANO
AIRE
PRINCIPAL

Altura	48 mm
Ancho	190 mm
Ancho 2	0 mm
Longitud	277 mm
Longitud 2	0 mm
-	-

APLICACIONES
MAZDA



AP31100
LD / LIVIANO
AIRE
PRINCIPAL

Altura	54 mm
Ancho	146 mm
Ancho 2	0 mm
Longitud	255 mm
Longitud 2	0 mm
-	-

APLICACIONES
HYUNDAI / KIA



AP311001
LD / LIVIANO
AIRE
PRINCIPAL

Altura	39 mm
Ancho	209 mm
Ancho 2	0 mm
Longitud	3203 mm
Longitud 2	0 mm
-	-

APLICACIONES
SUZUKI



AP311005
LD / LIVIANO
AIRE
PRINCIPAL

Altura	54 mm
Ancho	246 mm
Ancho 2	0 mm
Longitud	144 mm
Longitud 2	0 mm
-	-

APLICACIONES
HYUNDAI



AP311007
LD / LIVIANO
AIRE
PRINCIPAL

Altura	60 mm
Ancho	270 mm
Ancho 2	0 mm
Longitud	209 mm
Longitud 2	0 mm
-	-

APLICACIONES
JAC



AP311019
LD / LIVIANO
AIRE
PRINCIPAL

Altura	34.8 mm
Ancho	226 mm
Ancho 2	0 mm
Longitud	210 mm
Longitud 2	0 mm
-	-

APLICACIONES
MAZDA



AP311020
LD / LIVIANO
AIRE
PRINCIPAL

Altura	62 mm
Ancho	342 mm
Ancho 2	0 mm
Longitud	258 mm
Longitud 2	0 mm
-	-

APLICACIONES
HYUNDAI



AP311028
LD / LIVIANO
AIRE
PRINCIPAL

Altura	51 mm
Ancho	258 mm
Ancho 2	0 mm
Longitud	162 mm
Longitud 2	0 mm
-	-

APLICACIONES
HYUNDAI



AP311032
LD / LIVIANO
AIRE
PRINCIPAL

Altura	36 mm
Ancho	248 mm
Ancho 2	0 mm
Longitud	172 mm
Longitud 2	0 mm
-	-

APLICACIONES
CHERY



AP311033
LD / LIVIANO
AIRE
PRINCIPAL

Altura	53.7 mm
Ancho	245 mm
Ancho 2	0 mm
Longitud	160 mm
Longitud 2	0 mm
-	-

APLICACIONES
HYUNDAI



AP311035
LD / LIVIANO
AIRE
PRINCIPAL

Altura	45 mm
Ancho	233 mm
Ancho 2	0 mm
Longitud	145 mm
Longitud 2	0 mm
-	-

APLICACIONES
CHERY



AP311036

LD / LIVIANO
AIRE
PRINCIPAL

Altura	35,8 mm
Ancho	275 mm
Ancho 2	0 mm
Longitud	242 mm
Longitud 2	0 mm
-	-

APLICACIONES
CHERY



AP3111

LD / LIVIANO
AIRE
PRINCIPAL

Altura	35 mm
Ancho	202 mm
Ancho 2	0 mm
Longitud	315 mm
Longitud 2	0 mm
-	-

APLICACIONES
MAZDA



AP3112

LDD / LIVIANO DIÉSEL
AIRE
PRINCIPAL

Altura	32 mm
Ancho	237 mm
Ancho 2	0 mm
Longitud	299 mm
Longitud 2	0 mm
-	-

APLICACIONES
KIA



AP3113

LD / LIVIANO
AIRE
PRINCIPAL

Altura	35 mm
Ancho	255 mm
Ancho 2	0 mm
Longitud	310 mm
Longitud 2	0 mm
-	-

APLICACIONES
DAIHATSU



AP3115

LD / LIVIANO
AIRE
PRINCIPAL

Altura	63.5 mm
Ancho	239 mm
Ancho 2	0 mm
Longitud	239 mm
Longitud 2	0 mm
-	-

APLICACIONES
MITSUBISHI



AP3117

LD / LIVIANO
AIRE
PRINCIPAL

Altura	48 mm
Ancho	176 mm
Ancho 2	0 mm
Longitud	228 mm
Longitud 2	0 mm
-	-

APLICACIONES
CHEVROLET / SUZUKI



AP3118

LD / LIVIANO
AIRE
PRINCIPAL

Altura	38.3 mm
Ancho	224 mm
Ancho 2	0 mm
Longitud	224 mm
Longitud 2	0 mm
-	-

APLICACIONES
MITSUBISHI



AP3119

LD / LIVIANO
AIRE
PRINCIPAL

Altura	70 mm
Ancho	173 mm
Ancho 2	0 mm
Longitud	0 mm
Longitud 2	0 mm
-	-

APLICACIONES
CHEVROLET



AP3120

LD / LIVIANO
AIRE
PRINCIPAL

Altura	31 mm
Ancho	179 mm
Ancho 2	0 mm
Longitud	235 mm
Longitud 2	0 mm
-	-

APLICACIONES
HYUNDAI



AP3121

LD / LIVIANO
AIRE
PRINCIPAL

Altura	38 mm
Ancho	183 mm
Ancho 2	0 mm
Longitud	263 mm
Longitud 2	0 mm
-	-

APLICACIONES
KIA



AP3122

LD / LIVIANO
AIRE
PRINCIPAL

Altura	53 mm
Ancho	160 mm
Ancho 2	0 mm
Longitud	305 mm
Longitud 2	0 mm
-	-

APLICACIONES
KIA



AP3123

LD / LIVIANO
AIRE
PRINCIPAL

Altura	52 mm
Ancho	120 mm
Ancho 2	0 mm
Longitud	250 mm
Longitud 2	0 mm
-	-

APLICACIONES
TOYOTA



AP3125
LD / LIVIANO
AIRE
PRINCIPAL

Altura	50 mm
Ancho	135 mm
Ancho 2	105 mm
Longitud	378 mm
Longitud 2	0 mm
-	-

APLICACIONES
TOYOTA



AP3127
LDD / LIVIANO DIÉSEL
AIRE
PRINCIPAL

Altura	45 mm
Ancho	188 mm
Ancho 2	0 mm
Longitud	265 mm
Longitud 2	0 mm
-	-

APLICACIONES
NISSAN



AP3128
LD / LIVIANO
AIRE
PRINCIPAL

Altura	50 mm
Ancho	205 mm
Ancho 2	0 mm
Longitud	213 mm
Longitud 2	0 mm
-	-

APLICACIONES
MITSUBISHI



AP3129
LD / LIVIANO
AIRE
PRINCIPAL

Altura	42 mm
Ancho	156 mm
Ancho 2	0 mm
Longitud	310 mm
Longitud 2	0 mm
-	-

APLICACIONES
TOYOTA



AP3132
LD / LIVIANO
AIRE
PRINCIPAL

Altura	35 mm
Ancho	135 mm
Ancho 2	0 mm
Longitud	230 mm
Longitud 2	0 mm
-	-

APLICACIONES
NISSAN



AP3133
LD / LIVIANO
AIRE
PRINCIPAL

Altura	42 mm
Ancho	170 mm
Ancho 2	0 mm
Longitud	266 mm
Longitud 2	0 mm
-	-

APLICACIONES
TOYOTA



AP3136
LD / LIVIANO
AIRE
PRINCIPAL

Altura	52 mm
Ancho	206 mm
Ancho 2	0 mm
Longitud	245 mm
Longitud 2	0 mm
-	-

APLICACIONES
LAND ROVER / TOYOTA



AP3137
LD / LIVIANO
AIRE
PRINCIPAL

Altura	43 mm
Ancho	185 mm
Ancho 2	0 mm
Longitud	210 mm
Longitud 2	0 mm
-	-

APLICACIONES
HONDA



AP3138
LD / LIVIANO
AIRE
PRINCIPAL

Altura	53 mm
Ancho	186 mm
Ancho 2	0 mm
Longitud	232 mm
Longitud 2	0 mm
-	-

APLICACIONES
MITSUBISHI



AP3139
LD / LIVIANO
AIRE
PRINCIPAL

Altura	43 mm
Ancho	167 mm
Ancho 2	0 mm
Longitud	274 mm
Longitud 2	0 mm
-	-

APLICACIONES
HONDA



AP3140
LD / LIVIANO
AIRE
PRINCIPAL

Altura	48 mm
Ancho	175 mm
Ancho 2	0 mm
Longitud	320 mm
Longitud 2	0 mm
-	-

APLICACIONES
FAW / MAZDA



AP3142
LD / LIVIANO
AIRE
PRINCIPAL

Altura	41.1 mm
Ancho	154 mm
Ancho 2	0 mm
Longitud	247 mm
Longitud 2	0 mm
-	-

APLICACIONES
DAIHATSU / JAC



AP3143

LD / LIVIANO
AIRE
PRINCIPAL

Altura	50 mm
Ancho	240 mm
Ancho 2	0 mm
Longitud	240 mm
Longitud 2	0 mm
-	-

APLICACIONES
CHEVROLET



AP3144

LD / LIVIANO
AIRE
PRINCIPAL

Altura	50 mm
Ancho	190 mm
Ancho 2	0 mm
Longitud	200 mm
Longitud 2	0 mm
-	-

APLICACIONES
HYUNDAI / KIA MOTORS



AP3145

LD / LIVIANO
AIRE
PRINCIPAL

Altura	54.5 mm
Ancho	164 mm
Ancho 2	0 mm
Longitud	258 mm
Longitud 2	0 mm
-	-

APLICACIONES
HYUNDAI / KIA MOTORS



AP3146

LD / LIVIANO
AIRE
PRINCIPAL

Altura	34 mm
Ancho	157 mm
Ancho 2	0 mm
Longitud	360 mm
Longitud 2	0 mm
-	-

APLICACIONES
CHEVROLET



AP31461

LD / LIVIANO
AIRE
PRINCIPAL

Altura	31 mm
Ancho	115 mm
Ancho 2	0 mm
Longitud	230 mm
Longitud 2	0 mm
-	-

APLICACIONES
NISSAN



AP31511

LD / LIVIANO
AIRE
PRINCIPAL

Altura	43 mm
Ancho	207 mm
Ancho 2	0 mm
Longitud	257 mm
Longitud 2	0 mm
-	-

APLICACIONES
CHEVROLET



AP31521

LD / LIVIANO
AIRE
PRINCIPAL

Altura	39 mm
Ancho	158 mm
Ancho 2	0 mm
Longitud	244.5 mm
Longitud 2	0 mm
-	-

APLICACIONES
FORD

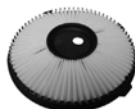

AP31528

LD / LIVIANO
AIRE
PRINCIPAL

Altura	45 mm
Ancho	19 mm
Ancho 2	0 mm
Longitud	255 mm
Longitud 2	0 mm
-	-

APLICACIONES
TOYOTA



AP31531

LD / LIVIANO
AIRE
PRINCIPAL

Altura	45 mm
Ancho	223 mm
Ancho 2	0 mm
Longitud	247 mm
Longitud 2	0 mm
-	-

APLICACIONES
MITSUBISHI



AP31542

LD / LIVIANO
AIRE
PRINCIPAL

Altura	40 mm
Ancho	202 mm
Ancho 2	0 mm
Longitud	246 mm
Longitud 2	0 mm
-	-

APLICACIONES
DAEWOO



AP31544

LD / LIVIANO
AIRE
PRINCIPAL

Altura	60 mm
Ancho	183 mm
Ancho 2	0 mm
Longitud	330 mm
O. Montura	12 mm
-	-

APLICACIONES
NISSAN



AP31550

LD / LIVIANO
AIRE
PRINCIPAL

Altura	50 mm
Ancho	165 mm
Ancho 2	0 mm
Longitud	226 mm
Longitud 2	0 mm
-	-

APLICACIONES
DAIHATSU



AP31551
LD / LIVIANO
AIRE
PRINCIPAL

Altura	53.5 mm
Ancho	160 mm
Ancho 2	0 mm
Longitud	190.5 mm
Longitud 2	0 mm
-	-

APLICACIONES
CHEVROLET



AP31555
LD / LIVIANO
AIRE
PRINCIPAL

Altura	33 mm
Ancho	21 mm
Ancho 2	0 mm
Longitud	253 mm
Longitud 2	0 mm
-	-

APLICACIONES
TOYOTA



AP31559
LD / LIVIANO
AIRE
PRINCIPAL

Altura	35 mm
Ancho	154 mm
Ancho 2	0 mm
Longitud	255 mm
Longitud 2	0 mm
-	-

APLICACIONES
MAZDA



AP31563
LD / LIVIANO
AIRE
PRINCIPAL

Altura	39 mm
Ancho	250 mm
Ancho 2	0 mm
Longitud	336 mm
Longitud 2	0 mm
-	-

APLICACIONES
MITSUBISHI



AP31592
LD / LIVIANO
AIRE
PRINCIPAL

Altura	40 mm
Ancho	166 mm
Ancho 2	0 mm
Longitud	227 mm
Longitud 2	0 mm
-	-

APLICACIONES
TOYOTA



AP31622
LD / LIVIANO
AIRE
PRINCIPAL

Altura	35 mm
Ancho	203 mm
Ancho 2	0 mm
Longitud	298 mm
Longitud 2	0 mm
-	-

APLICACIONES
KIA



AP31624
LD / LIVIANO
AIRE
PRINCIPAL

Altura	50 mm
Ancho	233 mm
Ancho 2	0 mm
Longitud	358 mm
Longitud 2	0 mm
-	-

APLICACIONES
MITSUBISHI



AP31628
LD / LIVIANO
AIRE
PRINCIPAL

Altura	50 mm
Ancho	150 mm
Ancho 2	0 mm
Longitud	290 mm
Longitud 2	0 mm
-	-

APLICACIONES
BYD / TOYOTA



AP31643
LD / LIVIANO
AIRE
PRINCIPAL

Altura	44 mm
Ancho	130 mm
Ancho 2	0 mm
Longitud	319 mm
Longitud 2	0 mm
-	-

APLICACIONES
DAIHATSU



AP31652
LDD / LIVIANO DIÉSEL
AIRE
PRINCIPAL

Altura	43 mm
Ancho	209 mm
Ancho 2	0 mm
Longitud	245 mm
Longitud 2	0 mm
-	-

APLICACIONES
HYUNDAI



AP31653
LD / LIVIANO
AIRE
PRINCIPAL

Altura	46 mm
Ancho	120 mm
Ancho 2	0 mm
Longitud	248 mm
Longitud 2	0 mm
-	-

APLICACIONES
GREAT WALL / TOYOTA



AP31678
LD / LIVIANO
AIRE
PRINCIPAL

Altura	42 mm
Ancho	190 mm
Ancho 2	0 mm
Longitud	239 mm
Longitud 2	0 mm
-	-

APLICACIONES
HYUNDAI



AP31697

LD / LIVIANO
AIRE
PRINCIPAL

Altura	60 mm
Ancho	174 mm
Ancho 2	0 mm
Longitud	270 mm
Longitud 2	0 mm
-	-

APLICACIONES
HYUNDAI



AP3170

LD / LIVIANO
AIRE
PRINCIPAL

Altura	52 mm
Ancho	200 mm
Ancho 2	0 mm
Longitud	311 mm
Longitud 2	0 mm
-	-

APLICACIONES
CHEVROLET



AP31700

LD / LIVIANO
AIRE
PRINCIPAL

Altura	40 mm
Ancho	107 mm
Ancho 2	0 mm
Longitud	330 mm
Longitud 2	0 mm
-	-

APLICACIONES
HONDA

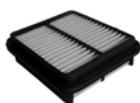

AP31701

LD / LIVIANO
AIRE
PRINCIPAL

Altura	48 mm
Ancho	155 mm
Ancho 2	0 mm
Longitud	175 mm
Longitud 2	0 mm
-	-

APLICACIONES
HAFEI



AP31711

LD / LIVIANO
AIRE
PRINCIPAL

Altura	45 mm
Ancho	190 mm
Ancho 2	0 mm
Longitud	270 mm
Longitud 2	0 mm
-	-

APLICACIONES
GREAT WALL

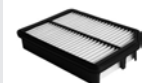

AP31734

LD / LIVIANO
AIRE
PRINCIPAL

Altura	45 mm
Ancho	172 mm
Ancho 2	0 mm
Longitud	250 mm
Longitud 2	0 mm
-	-

APLICACIONES
KIA



AP31744

LD / LIVIANO
AIRE
PRINCIPAL

Altura	54 mm
Ancho	130 mm
Ancho 2	0 mm
Longitud	247 mm
Longitud 2	0 mm
-	-

APLICACIONES
KIA



AP31747

LD / LIVIANO
AIRE
PRINCIPAL

Altura	78 mm
Ancho	101 mm
Ancho 2	0 mm
Longitud	274 mm
Longitud 2	0 mm
-	-

APLICACIONES
HYUNDAI



AP31753

LDD / LIVIANO DIÉSEL
AIRE
PRINCIPAL

Altura	52 mm
Ancho	296 mm
Ancho 2	0 mm
Longitud	315 mm
Longitud 2	0 mm
-	-

APLICACIONES
TOYOTA



AP31773

LD / LIVIANO
AIRE
PRINCIPAL

Altura	49 mm
Ancho	169 mm
Ancho 2	0 mm
Longitud	268.5 mm
Longitud 2	0 mm
-	-

APLICACIONES
HONDA



AP3178

LD / LIVIANO
AIRE
PRINCIPAL

Altura	51.5 mm
Ancho	142 mm
Ancho 2	0 mm
Longitud	292 mm
Longitud 2	0 mm
-	-

APLICACIONES
CHEVROLET / MITSUBISHI
VOLKSWAGEN



AP31785

LD / LIVIANO
AIRE
PRINCIPAL

Altura	31.5 mm
Ancho	187.5 mm
Ancho 2	0 mm
Longitud	419 mm
Longitud 2	0 mm
-	-

APLICACIONES
VOLKSWAGEN



AP31788
LD / LIVIANO
AIRE
PRINCIPAL

Altura	64.5 mm
Ancho	185 mm
Ancho 2	0 mm
Longitud	267 mm
Longitud 2	0 mm
-	-

APLICACIONES
MITSUBISHI



AP31797
LD / LIVIANO
AIRE
PRINCIPAL

Altura	41.5 mm
Ancho	227 mm
Ancho 2	0 mm
Longitud	277 mm
Longitud 2	0 mm
-	-

APLICACIONES
HYUNDAI



AP31801
LD / LIVIANO
AIRE
PRINCIPAL

Altura	52 mm
Ancho	175 mm
Ancho 2	0 mm
Longitud	242 mm
Longitud 2	0 mm
-	-

APLICACIONES
TOYOTA



AP31806
LD / LIVIANO
AIRE
PRINCIPAL

Altura	84.5 mm
Ancho	237 mm
Ancho 2	167 mm
Longitud	243 mm
Longitud 2	140 mm
-	-

APLICACIONES
TOYOTA



AP3181
LD / LIVIANO
AIRE
PRINCIPAL

Altura	40 mm
Ancho	140 mm
Ancho 2	0 mm
Longitud	238 mm
Longitud 2	0 mm
-	-

APLICACIONES
CHEVROLET



AP31820
LD / LIVIANO
AIRE
PRINCIPAL

Altura	34 mm
Ancho	133 mm
Ancho 2	0 mm
Longitud	214 mm
Longitud 2	0 mm
-	-

APLICACIONES
KIA



AP31828
LD / LIVIANO
AIRE
PRINCIPAL

Altura	48 mm
Ancho	223 mm
Ancho 2	0 mm
Longitud	267 mm
Longitud 2	0 mm
-	-

APLICACIONES
CHEVROLET



AP31832
LD / LIVIANO
AIRE
PRINCIPAL

Altura	52.1 mm
Ancho	163.6 mm
Ancho 2	0 mm
Longitud	257 mm
Longitud 2	0 mm
-	-

APLICACIONES
HYUNDAI / KIA



AP31857
LD / LIVIANO
AIRE
PRINCIPAL

Altura	56 mm
Ancho	143 mm
Ancho 2	0 mm
Longitud	218 mm
Longitud 2	0 mm
-	-

APLICACIONES
SSANGYONG



AP31861
LD / LIVIANO
AIRE
PRINCIPAL

Altura	44 mm
Ancho	220 mm
Ancho 2	0 mm
Longitud	246 mm
Longitud 2	0 mm
-	-

APLICACIONES
CHERY



AP31874
LDD / LIVIANO DIÉSEL
AIRE
PRINCIPAL

D. Exterior	163 mm
D. Interior	97 mm
Altura	302 mm
D. Montaje	0 mm
Tipo	Aire Redondo
Sello	Radial
-	-

APLICACIONES
CITROEN / PEUGEOT / RAM



AP31899
LD / LIVIANO
AIRE
PRINCIPAL

Altura	39 mm
Ancho	179 mm
Ancho 2	0 mm
Longitud	270 mm
Longitud 2	0 mm
-	-

APLICACIONES
MAZDA

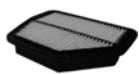

AP3190

LD / LIVIANO
AIRE
PRINCIPAL

Altura	50 mm
Ancho	228 mm
Ancho 2	0 mm
Longitud	283 mm
Longitud 2	0 mm
-	-

APLICACIONES
CHEVROLET



AP31900

LD / LIVIANO
AIRE
PRINCIPAL

Altura	36 mm
Ancho	227 mm
Ancho 2	0 mm
Longitud	300 mm
Longitud 2	0 mm
-	-

APLICACIONES
KIA / HYUNDAI



AP31905

LD / LIVIANO
AIRE
PRINCIPAL

Altura	31 mm
Ancho	142 mm
Ancho 2	0 mm
Longitud	233 mm
Longitud 2	0 mm
-	-

APLICACIONES
SUZUKI



AP31920

LD / LIVIANO
AIRE
PRINCIPAL

Altura	37 mm
Ancho	294 mm
Ancho 2	0 mm
Longitud	197 mm
Longitud 2	0 mm
-	-

APLICACIONES
HYUNDAI / KIA



AP31923

LD / LIVIANO
AIRE
PRINCIPAL

Altura	46 mm
Ancho	247 mm
Ancho 2	0 mm
Longitud	261 mm
Longitud 2	0 mm
-	-

APLICACIONES
GREAT WALL



AP31928

LD / LIVIANO
AIRE
PRINCIPAL

Altura	51 mm
Ancho	216 mm
Ancho 2	0 mm
Longitud	240 mm
Longitud 2	0 mm
-	-

APLICACIONES
SUZUKI



AP3193

LDD / LIVIANO DIÉSEL
AIRE
PRINCIPAL

D. Exterior	153 mm
D. Interior	88.1 mm
Altura	198.3 mm
D. Montaje	12.8 mm
Tipo	Aire Redondo
Sello	Axial

APLICACIONES
JMC / MITSUBISHI / NISSAN
TOYOTA / DAIHATSU / HAFEI



AP31930

LD / LIVIANO
AIRE
PRINCIPAL

Altura	45 mm
Ancho	192 mm
Ancho 2	0 mm
Longitud	265 mm
Longitud 2	0 mm
-	-

APLICACIONES
CHERY



AP31935

LDD / LIVIANO DIÉSEL
AIRE
PRINCIPAL

Altura	55 mm
Ancho	237 mm
Ancho 2	0 mm
Longitud	298 mm
Longitud 2	0 mm
-	-

APLICACIONES
SSANGYONG



AP31936

LD / LIVIANO
AIRE
PRINCIPAL

Altura	32 mm
Ancho	105 mm
Ancho 2	0 mm
Longitud	355 mm
Longitud 2	0 mm
-	-

APLICACIONES
HYUNDAI



AP31942

LD / LIVIANO
AIRE
PRINCIPAL

Altura	45 mm
Ancho	298 mm
Ancho 2	0 mm
Longitud	349 mm
Longitud 2	0 mm
-	-

APLICACIONES
HYUNDAI



AP31944

LD / LIVIANO
AIRE
PRINCIPAL

Altura	28 mm
Ancho	292 mm
Ancho 2	0 mm
Longitud	287 mm
Longitud 2	0 mm
-	-

APLICACIONES
NISSAN



AP3195
LD / LIVIANO
AIRE
PRINCIPAL

Altura	55.5 mm
Ancho	199 mm
Ancho 2	0 mm
Longitud	225 mm
Longitud 2	0 mm
-	-

APLICACIONES
CHEVROLET



AP31950
LD / LIVIANO
AIRE
PRINCIPAL

Altura	52 mm
Ancho	207 mm
Ancho 2	0 mm
Longitud	256 mm
Longitud 2	0 mm
-	-

APLICACIONES
MITSUBISHI



AP3196
LD / LIVIANO
AIRE
PRINCIPAL

Altura	44.5 mm
Ancho	188 mm
Ancho 2	0 mm
Longitud	222 mm
Longitud 2	0 mm
-	-

APLICACIONES
CHEVROLET



AP31963
LD / LIVIANO
AIRE
PRINCIPAL

Altura	75 mm
Ancho	200 mm
Ancho 2	0 mm
Longitud	293 mm
Longitud 2	0 mm
-	-

APLICACIONES
RENAULT



AP31976
LDD / LIVIANO DIÉSEL
AIRE
PRINCIPAL

Altura	70 mm
Ancho	209 mm
Ancho 2	0 mm
Longitud	259 mm
Longitud 2	0 mm
-	-

APLICACIONES
RENAULT



AP31980
LD / LIVIANO
AIRE
PRINCIPAL

Altura	41 mm
Ancho	195 mm
Ancho 2	0 mm
Longitud	275 mm
Longitud 2	0 mm
-	-

APLICACIONES
HYUNDAI



AP31984
LD / LIVIANO
AIRE
PRINCIPAL

Altura	34 mm
Ancho	166 mm
Ancho 2	0 mm
Longitud	288 mm
Longitud 2	0 mm
-	-

APLICACIONES
SUZUKI



AP31985
LD / LIVIANO
AIRE
PRINCIPAL

Altura	41 mm
Ancho	171 mm
Ancho 2	0 mm
Longitud	275 mm
Longitud 2	0 mm
-	-

APLICACIONES
HYUNDAI / KIA



AP31990
LD / LIVIANO
AIRE
PRINCIPAL

Altura	40 mm
Ancho	190 mm
Ancho 2	0 mm
Longitud	325 mm
Longitud 2	0 mm
-	-

APLICACIONES
CHERY



AP31992
LD / LIVIANO
AIRE
PRINCIPAL

Altura	62 mm
Ancho	199 mm
Ancho 2	0 mm
Longitud	246 mm
Longitud 2	0 mm
-	-

APLICACIONES
FORD / LINCOLN



AP323
LD / LIVIANO
AIRE
PRINCIPAL

D. Exterior	285 mm
D. Interior	227 mm
Altura	45 mm
D. Menor	231 mm
Tipo	Aire Redondo
Sello	Axial

APLICACIONES
MAZDA



AP3270
LDD / LIVIANO DIÉSEL
AIRE
PRINCIPAL

D. Exterior	176 mm
D. Interior	95 mm
Altura	184 mm
D. Montura	0 mm
Tipo	Aire Redondo
Sello	Radial

APLICACIONES
NISSAN



AP33

LD / LIVIANO
AIRE
PRINCIPAL

D. Exterior	230 mm
D. Interior	168 mm
Altura	90 mm
D. Montura	0 mm
Tipo	Aire Redondo
Sello	Axial

APLICACIONES
MITSUBISHI

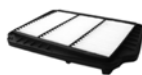

AP3450

LD / LIVIANO
AIRE
PRINCIPAL

Altura	34 mm
Ancho	221 mm
Ancho 2	0 mm
Longitud	289 mm
Longitud 2	0 mm
-	-

APLICACIONES
CHEVROLET



AP3500

LD / LIVIANO
AIRE
PRINCIPAL

D. Exterior	201 mm
D. Interior	125 mm
Altura	188.5 mm
D. Montura	15 mm
Tipo	Aire Redondo
Sello	Axial

APLICACIONES
HYUNDAI / MITSUBISHI



AP3501

MD / MEDIANO
AIRE
SECUNDARIO

D. Exterior	131 mm
D. Interior	94.7 mm
Altura	302.5 mm
D. Montura	0 mm
Tipo	Aire Redondo
Sello	Radial

APLICACIONES
CHEVROLET



AP3509

LD / LIVIANO
AIRE
PRINCIPAL

Altura	50 mm
Ancho	171 mm
Ancho 2	0 mm
Longitud	242 mm
Longitud 2	0 mm
-	-

APLICACIONES
CHEVROLET



AP350990

LD / LIVIANO
AIRE
PRINCIPAL

Altura	50 mm
Ancho	171 mm
Ancho 2	0 mm
Longitud	242 mm
Longitud 2	0 mm
-	-

APLICACIONES
CHEVROLET



AP3511

LD / LIVIANO
AIRE
PRINCIPAL

Altura	43 mm
Ancho	149 mm
Ancho 2	0 mm
Longitud	238 mm
Longitud 2	0 mm
-	-

APLICACIONES
MAZDA



AP3513

LD / LIVIANO
AIRE
PRINCIPAL

Altura	42 mm
Ancho	238 mm
Ancho 2	0 mm
Longitud	291 mm
Longitud 2	0 mm
-	-

APLICACIONES
CHEVROLET

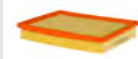

AP3514

LD / LIVIANO
AIRE
PRINCIPAL

Altura	38.5 mm
Ancho	189 mm
Ancho 2	0 mm
Longitud	253 mm
Longitud 2	0 mm
-	-

APLICACIONES
CHEVROLET / FOTON



AP3517

LD / LIVIANO
AIRE
PRINCIPAL

Altura	56 mm
Ancho	156 mm
Ancho 2	0 mm
Longitud	328 mm
Longitud 2	0 mm
-	-

APLICACIONES
CITROEN



AP3518

HD / PESADO
AIRE
PRINCIPAL

D. Exterior	332 mm
D. Interior	175 mm
Altura	385 mm
D. Montura	0 mm
Tipo	Aire Redondo
Sello	Radial

APLICACIONES
CHEVROLET / FORD
FREIGHTLINER / INTERNATIONAL



AP351833

LD / LIVIANO
AIRE
PRINCIPAL

Altura	38 mm
Ancho	205 mm
Ancho 2	0 mm
Longitud	262 mm
Longitud 2	0 mm
-	-

APLICACIONES
CHEVROLET



AP3518SY

HD / PESADO
AIRE
SECUNDARIO

D. Exterior	175.6 mm
D. Interior	149.8 mm
Altura	368.5 mm
D. Montura	0 mm
Tipo	Aire Redondo
Sello	Radial

APLICACIONES
INTERNATIONAL



AP3524

LD / LIVIANO
AIRE
PRINCIPAL

Altura	55 mm
Ancho	194 mm
Ancho 2	0 mm
Longitud	268 mm
Longitud 2	0 mm
-	-

APLICACIONES
KIA



AP352660

LD / LIVIANO
AIRE
PRINCIPAL

Altura	57 mm
Ancho	238 mm
Ancho 2	0 mm
Longitud	253 mm
Longitud 2	0 mm
-	-

APLICACIONES
CHEVROLET



AP3527

LD / LIVIANO
AIRE
PRINCIPAL

Altura	55.5 mm
Ancho	229 mm
Ancho 2	0 mm
Longitud	267 mm
Longitud 2	0 mm
-	-

APLICACIONES
VOLKSWAGEN



AP3531

LD / LIVIANO
AIRE
PRINCIPAL

Altura	40 mm
Ancho	150 mm
Ancho 2	0 mm
Longitud	408 mm
Longitud 2	0 mm
-	-

APLICACIONES
FORD



AP3532

LD / LIVIANO
AIRE
PRINCIPAL

Altura	137 mm
Ancho	145 mm
Ancho 2	0 mm
Longitud	255 mm
Longitud 2	190 mm
Sello	Radial

APLICACIONES
HYUNDAI / KIA



AP3533

LD / LIVIANO
AIRE
PRINCIPAL

Altura	34 mm
Ancho	169 mm
Ancho 2	0 mm
Longitud	226 mm
Longitud 2	0 mm
-	-

APLICACIONES
NISSAN / SUBARU



AP3537

LD / LIVIANO
AIRE
PRINCIPAL

Altura	37 mm
Ancho	246 mm
Ancho 2	0 mm
Longitud	256 mm
Longitud 2	0 mm
-	-

APLICACIONES
CHEVROLET



AP3539

HD / PESADO
AIRE
PRINCIPAL

Flujo invertido

D. Exterior	276 mm
D. Interior	173 mm
Altura	600 mm
D. Montura	95.4 mm
Tipo	Aire Redondo
Sello	Radial

APLICACIONES
FREIGHTLINER / KENWORTH



AP3542

OTROS
AIRE
PRINCIPAL

D. Exterior	138 mm
D. Interior	81 mm
Altura	327.6 mm
D. Montura	0 mm
Tipo	Aire Redondo
Sello	Radial

APLICACIONES
BOBCAT



AP3543

OTROS
AIRE
SECUNDARIO

D. Exterior	82 mm
D. Interior	61 mm
Altura	311 mm
D. Montura	0 mm
Tipo	Aire Redondo
Sello	Radial

APLICACIONES
BOBCAT



AP3544P

OTROS
AIRE
PRINCIPAL

D. Exterior	163 mm
D. Interior	90 mm
Altura	353 mm
D. Montura	0 mm
Tipo	Aire Redondo
Sello	Radial

APLICACIONES
CASE / CATERPILLAR
NEW HOLLAN / VOLVO



AP3545

**OTROS
AIRE
SECUNDARIO**

D. Exterior	92 mm
D. Interior	66 mm
Altura	341 mm
D. Montura	0 mm
Tipo	Aire Redondo
Sello	Radial

APLICACIONES
CASE / CATERPILLAR
NEW HOLLAN / VOLVO



AP3548

**HD / PESADO
AIRE
PRINCIPAL**

D. Exterior	280 mm
D. Interior	147 mm
Altura	397 mm
D. Montura	0 mm
Tipo	Aire Redondo
Sello	Radial

APLICACIONES
AGRALE / CHEVROLET
INTERNATIONAL / KENWORTH

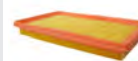

AP3550

**LD / LIVIANO
AIRE
PRINCIPAL**

Altura	30.5 mm
Ancho	167 mm
Ancho 2	0 mm
Longitud	271 mm
Longitud 2	0 mm
-	-

APLICACIONES
HYUNDAI



AP355344

**LD / LIVIANO
AIRE
PRINCIPAL**

Altura	60 mm
Ancho	213 mm
Ancho 2	0 mm
Longitud	236 mm
Longitud 2	0 mm
-	-

APLICACIONES
VOLVO



AP3554

**LD / LIVIANO
AIRE
PRINCIPAL**

Altura	73 mm
Ancho	103 mm
Ancho 2	0 mm
Longitud	172 mm
Longitud 2	141 mm
-	-

APLICACIONES
RENAULT / SSANGYONG



AP35553

**LD / LIVIANO
AIRE
PRINCIPAL**

D. Exterior	370 mm
D. Interior	206.7 mm
Altura	71 mm
D. Menor	301 mm
Tipo	Aire Redondo
Sello	Axial

APLICACIONES
NISSAN



AP35591

**LD / LIVIANO
AIRE
PRINCIPAL**

Altura	51 mm
Ancho	185 mm
Ancho 2	0 mm
Longitud	365 mm
Longitud 2	0 mm
-	-

APLICACIONES
SKODA / VOLKSWAGEN



AP35594

**LDD / LIVIANO DIÉSEL
AIRE
PRINCIPAL**

Altura	57 mm
Ancho	180 mm
Ancho 2	0 mm
Longitud	280 mm
Longitud 2	0 mm
-	-

APLICACIONES
NISSAN



AP356020

**LD / LIVIANO
AIRE
PRINCIPAL**

Altura	58 mm
Ancho	162 mm
Ancho 2	0 mm
Longitud	234 mm
Longitud 2	0 mm
-	-

APLICACIONES
CHEVROLET



AP35606

**LD / LIVIANO
AIRE
PRINCIPAL**

Altura	37 mm
Ancho	167 mm
Ancho 2	0 mm
Longitud	258 mm
Longitud 2	0 mm
-	-

APLICACIONES
MAZDA



AP35607

**LD / LIVIANO
AIRE
PRINCIPAL**

Altura	41.5 mm
Ancho	186 mm
Ancho 2	0 mm
Longitud	285 mm
Longitud 2	0 mm
-	-

APLICACIONES
SKODA

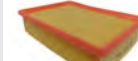

AP35644

**LD / LIVIANO
AIRE
PRINCIPAL**

Altura	58 mm
Ancho	175 mm
Ancho 2	0 mm
Longitud	242 mm
Longitud 2	0 mm
-	-

APLICACIONES
BMW / TOYOTA



AP35665
LD / LIVIANO
AIRE
PRINCIPAL

Altura	50 mm
Ancho	184 mm
Ancho 2	0 mm
Longitud	365 mm
Longitud 2	0 mm
-	-

APLICACIONES
VOLKSWAGEN



AP3567
LD / LIVIANO
AIRE
PRINCIPAL

Altura	41 mm
Ancho	182 mm
Ancho 2	0 mm
Longitud	262 mm
Longitud 2	0 mm
-	-

APLICACIONES
CITROEN



AP35672
LD / LIVIANO
AIRE
PRINCIPAL

Altura	79 mm
Ancho	171 mm
Ancho 2	0 mm
Longitud	206 mm
Longitud 2	0 mm
-	-

APLICACIONES
PEUGEOT



AP3570
LDD / LIVIANO DIÉSEL
AIRE
PRINCIPAL

Altura	80 mm
Ancho	280 mm
Ancho 2	0 mm
Longitud	319 mm
Longitud 2	0 mm
-	-

APLICACIONES
MERCEDES BENZ



AP3571
LD / LIVIANO
AIRE
PRINCIPAL

Altura	60 mm
Ancho	120 mm
Ancho 2	0 mm
Longitud	350 mm
Longitud 2	0 mm
-	-

APLICACIONES
CHEVROLET



AP35733
LD / LIVIANO
AIRE
PRINCIPAL

Altura	33.5 mm
Ancho	158.4 mm
Ancho 2	0 mm
Longitud	170.4 mm
Longitud 2	0 mm
-	-

APLICACIONES
NISSAN



AP3574
LD / LIVIANO
AIRE
PRINCIPAL

Altura	37 mm
Ancho	246 mm
Ancho 2	0 mm
Longitud	290 mm
Longitud 2	0 mm
-	-

APLICACIONES
JEEP / NISSAN



AP35741
LD / LIVIANO
AIRE
PRINCIPAL

Altura	27 mm
Ancho	165 mm
Ancho 2	0 mm
Longitud	326 mm
Longitud 2	0 mm
-	-

APLICACIONES
JEEP



AP35756
LD / LIVIANO
AIRE
PRINCIPAL

Altura	57.5 mm
Ancho	264 mm
Ancho 2	0 mm
Longitud	349 mm
Longitud 2	0 mm
-	-

APLICACIONES
FORD



AP35758
LDD / LIVIANO DIÉSEL
AIRE
PRINCIPAL

Altura	63.5 mm
Ancho	188 mm
Ancho 2	0 mm
Longitud	311 mm
Longitud 2	0 mm
-	-

APLICACIONES
VOLKSWAGEN



AP3578
LD / LIVIANO
AIRE
PRINCIPAL

Altura	39 mm
Ancho	165 mm
Ancho 2	0 mm
Longitud	205 mm
Longitud 2	0 mm
-	-

APLICACIONES
HYUNDAI



AP35781
LDD / LIVIANO DIÉSEL
AIRE
PRINCIPAL

Altura	59 mm
Ancho	256 mm
Ancho 2	0 mm
Longitud	312 mm
Longitud 2	0 mm
-	-

APLICACIONES
VOLKSWAGEN



AP35782

LD / LIVIANO
AIRE
PRINCIPAL

Altura	44.6 mm
Ancho	166 mm
Ancho 2	0 mm
Longitud	303 mm
Longitud 2	0 mm
-	-

APLICACIONES
FORD



AP35783

LD / LIVIANO
AIRE
PRINCIPAL

Altura	47 mm
Ancho	213 mm
Ancho 2	0 mm
Longitud	231 mm
Longitud 2	0 mm
-	-

APLICACIONES
DODGE



AP35786

LD / LIVIANO
AIRE
PRINCIPAL

Altura	57 mm
Ancho	211 mm
Ancho 2	0 mm
Longitud	216 mm
Longitud 2	124 mm
-	-

APLICACIONES
FORD / SKODA / VOLKSWAGEN



AP35790

LD / LIVIANO
AIRE
PRINCIPAL

Altura	40.5 mm
Ancho	190 mm
Ancho 2	0 mm
Longitud	237 mm
Longitud 2	0 mm
-	-

APLICACIONES
HYUNDAI / KIA



AP35793

LD / LIVIANO
AIRE
PRINCIPAL

Altura	48.5 mm
Ancho	161.7 mm
Ancho 2	0 mm
Longitud	285 mm
Longitud 2	0 mm
-	-

APLICACIONES
VOLKSWAGEN



AP35800

LDD / LIVIANO DIÉSEL
AIRE
PRINCIPAL

Altura	60 mm
Ancho	247 mm
Ancho 2	0 mm
Longitud	283 mm
Longitud 2	0 mm
-	-

APLICACIONES
RENAULT



AP3581

LD / LIVIANO
AIRE
PRINCIPAL

Altura	40 mm
Ancho	170 mm
Ancho 2	0 mm
Longitud	330 mm
Longitud 2	0 mm
-	-

APLICACIONES
KIA



AP3582

LD / LIVIANO
AIRE
PRINCIPAL

Altura	37 mm
Ancho	156 mm
Ancho 2	0 mm
Longitud	255 mm
Longitud 2	0 mm
-	-

APLICACIONES
KIA



AP35840

LD / LIVIANO
AIRE
PRINCIPAL

Altura	49 mm
Ancho	209 mm
Ancho 2	0 mm
Longitud	357 mm
Longitud 2	0 mm
-	-

APLICACIONES
FIAT



AP35843

LD / LIVIANO
AIRE
PRINCIPAL

Altura	45 mm
Ancho	100 mm
Ancho 2	0 mm
Longitud	331 mm
Longitud 2	0 mm
-	-

APLICACIONES
CITROËN / PEUGEOT



AP35844

LD / LIVIANO
AIRE
PRINCIPAL

Altura	65 mm
Ancho	161 mm
Ancho 2	0 mm
Longitud	196 mm
Longitud 2	162 mm
-	-

APLICACIONES
FORD



AP35846

LD / LIVIANO
AIRE
PRINCIPAL

Altura	58 mm
Ancho	190 mm
Ancho 2	0 mm
Longitud	204 mm
Longitud 2	0 mm
-	-

APLICACIONES
RENAULT



AP35862

LD / LIVIANO
AIRE
PRINCIPAL

Altura	140 mm
Ancho	135 mm
Ancho 2	0 mm
Longitud	222 mm
Longitud 2	0 mm
-	-

APLICACIONES
FORD / MAZDA



AP3588

LD / LIVIANO
AIRE
PRINCIPAL

Altura	52 mm
Ancho	143 mm
Ancho 2	0 mm
Longitud	240 mm
Longitud 2	0 mm
-	-

APLICACIONES
CHANA / DFSK / DONG FENG



AP35886

LD / LIVIANO
AIRE
PRINCIPAL

Altura	55 mm
Ancho	94 mm
Ancho 2	0 mm
Longitud	324 mm
Longitud 2	0 mm
-	-

APLICACIONES
RENAULT



AP35892

LD / LIVIANO
AIRE
PRINCIPAL

D. Exterior	222 mm
D. Interior	135 mm
Altura	140 mm
D. Montura	0 mm
Tipo	Aire Redondo
Sello	Radial

APLICACIONES
FORD / MAZDA



AP35893

LD / LIVIANO
AIRE
PRINCIPAL

D. Exterior	152 mm
D. Interior	70 mm
Altura	210 mm
D. Montura	0 mm
Tipo	Aire Redondo
Sello	Radial

APLICACIONES
FORD / VOLVO



AP35898

LD / LIVIANO
AIRE
PRINCIPAL

Altura	52 mm
Ancho	221 mm
Ancho 2	0 mm
Longitud	242 mm
Longitud 2	0 mm
-	-

APLICACIONES
DODGE / JEEP



AP35915

LDD / LIVIANO DIÉSEL
AIRE
PRINCIPAL

Altura	55 mm
Ancho	260 mm
Ancho 2	0 mm
Longitud	320 mm
Longitud 2	0 mm
-	-

APLICACIONES
FOTON



AP35917

LDD / LIVIANO DIÉSEL
AIRE
PRINCIPAL

Altura	59 mm
Ancho	192 mm
Ancho 2	0 mm
Longitud	345 mm
Longitud 2	0 mm
-	-

APLICACIONES
MAHINDRA



AP35921

LD / LIVIANO
AIRE
PRINCIPAL

Altura	67 mm
Ancho	185 mm
Ancho 2	0 mm
Longitud	170 mm
Longitud 2	0 mm
-	-

APLICACIONES
FORD



AP35932

LD / LIVIANO
AIRE
PRINCIPAL

Altura	47 mm
Ancho	233 mm
Ancho 2	0 mm
Longitud	235 mm
Longitud 2	0 mm
-	-

APLICACIONES
DODGE



AP35933

LD / LIVIANO
AIRE
PRINCIPAL

Altura	74 mm
Ancho	100 mm
Ancho 2	0 mm
Longitud	351 mm
Longitud 2	0 mm
-	-

APLICACIONES
PEUGEOT



AP35939

LD / LIVIANO
AIRE
PRINCIPAL

Altura	45 mm
Ancho	225 mm
Ancho 2	0 mm
Longitud	340 mm
Longitud 2	0 mm
-	-

APLICACIONES
VOLVO



AP35941
LD / LIVIANO
AIRE
PRINCIPAL

Altura	58 mm
Ancho	102 mm
Ancho 2	0 mm
Longitud	335 mm
Longitud 2	0 mm
-	-

APLICACIONES
CITROEN



AP35960
LD / LIVIANO
AIRE
PRINCIPAL

Altura	50 mm
Ancho	169 mm
Ancho 2	0 mm
Longitud	242 mm
Longitud 2	0 mm
-	-

APLICACIONES
CHEVROLET



AP35961
LD / LIVIANO
AIRE
PRINCIPAL

Altura	48 mm
Ancho	202 mm
Ancho 2	0 mm
Longitud	256 mm
Longitud 2	0 mm
-	-

APLICACIONES
NISSAN / RENAULT



AP35968
LD / LIVIANO
AIRE
PRINCIPAL

Altura	65 mm
Ancho	141 mm
Ancho 2	0 mm
Longitud	280 mm
Longitud 2	0 mm
-	-

APLICACIONES
RENAULT



AP35977
LD / LIVIANO
AIRE
PRINCIPAL

Altura	58 mm
Ancho	238 mm
Ancho 2	0 mm
Longitud	322 mm
Longitud 2	0 mm
-	-

APLICACIONES
TOYOTA



AP3600
LD / LIVIANO
AIRE
PRINCIPAL

D. Exterior	153 mm
D. Interior	88.1 mm
Altura	238.7 mm
D. Montura	12.7 mm
Tipo	Aire Redondo
Sello	Axial

APLICACIONES
KIA



AP3707
LD / LIVIANO
AIRE
PRINCIPAL

D. Exterior	163 mm
D. Interior	92 mm
Altura	278 mm
D. Montura	0 mm
Tipo	Aire Redondo
Sello	Radial

APLICACIONES
CHEVROLET



AP3716
OTRO
AIRE
PRINCIPAL

D. Exterior	104 mm
D. Interior	60 mm
Altura	278 mm
D. Montura	0 mm
Tipo	Aire Redondo
Sello	Radial

APLICACIONES
KUBOTA / FORD / HITACHI
JOHN DEERE / KOMATSU / NISSAN



AP3722
HD / PESADO
AIRE
SECUNDARIO

D. Exterior	148 mm
D. Interior	122 mm
Altura	378 mm
D. Montura	0 mm
Tipo	Aire Redondo
Sello	Radial

APLICACIONES
AGRALE / CHEVROLET
INTERNATIONAL / KENWORTH



AP3736
MD / MEDIANO
AIRE
PRINCIPAL

D. Exterior	232 mm
D. Interior	132 mm
Altura	341 mm
D. Montura	0 mm
Tipo	Aire Redondo
Sello	Radial

APLICACIONES
HINO



AP3737
MD / MEDIANO
AIRE
PRINCIPAL

D. Exterior	131 mm
D. Interior	94 mm
Altura	320 mm
D. Montura	0 mm
Tipo	Aire Redondo
Sello	Radial

APLICACIONES
HINO



AP3920
OTROS
AIRE
PRINCIPAL

D. Exterior	150 mm
D. Interior	85 mm
Altura	360 mm
D. Montaje	0 mm
Tipo	Aire Redondo
Sello	Radial

APLICACIONES
JBC



AP3921

OTROS
AIRE
INTERNO

D. Exterior	76.8 mm
D. Interior	60.9 mm
Altura	346 mm
D. Menor	75 mm
Tipo	Aire Redondo
Sello	Radial

APLICACIONES
JBC



AP3932

LD / LIVIANO
AIRE
PRINCIPAL

D. Exterior	208 mm
D. Interior	193 mm
Altura	172 mm
D. Menor	136 mm
Tipo	Aire Redondo
Sello	Axial

APLICACIONES
HYUNDAI



AP3936

HD / PESADO
AIRE
PRINCIPAL

D. Exterior	235 mm
D. Interior	147 mm
Altura	648 mm
D. Montura	0 mm
Tipo	Aire Redondo
Sello	Radial

APLICACIONES
MACK



AP3988

OTROS
AIRE
PRINCIPAL

D. Exterior	129 mm
D. Interior	81 mm
Altura	311 mm
D. Montaje	0 mm
Tipo	Aire Redondo
Sello	Radial

APLICACIONES
BOBCAT



AP4000

LDD / LIVIANO DIÉSEL
AIRE
PRINCIPAL

D. Exterior	132.8 mm
D. Interior	66.4 mm
Altura	283 mm
D. Montura	12.5 mm
Tipo	Aire Redondo
Sello	Axial

APLICACIONES
HYUNDAI



AP4001

LDD / LIVIANO DIÉSEL
AIRE
PRINCIPAL

D. Exterior	232 mm
D. Interior	135 mm
Altura	188.5 mm
D. Menor	172 mm
Tipo	Aire Redondo
Sello	Radial

APLICACIONES
HYUNDAI / JAC



AP4091

MD / MEDIANO
AIRE
SECUNDARIO

D. Exterior	125 mm
D. Interior	115 mm
Altura	473 mm
D. Montura	20 mm
Tipo	Aire Redondo
Sello	Axial

APLICACIONES
FOTON



AP4129908

OTROS
AIRE
INTERNO

D. Exterior	116.5 mm
D. Interior	87 mm
Altura	334 mm
D. Montaje	18 mm
Tipo	Aire Redondo
Sello	Axial

APLICACIONES
HITACHI



AP41702

MD / MEDIANO
AIRE
PRINCIPAL

D. Exterior	228.5 mm
D. Interior	116 mm
Altura	372.2 mm
D. Montaje	9.8 mm
Tipo	Aire Redondo
Sello	Axial

APLICACIONES
NON PLUS ULTRA / JMC



AP41702SY

MD / MEDIANO
AIRE
INTERNO

D. Exterior	105 mm
D. Interior	98 mm
Altura	380 mm
D. Montaje	0 mm
Tipo	Aire Redondo
Sello	Axial

APLICACIONES
NON PLUS ULTRA / JMC



AP4337

LD / LIVIANO
AIRE
PRINCIPAL

D. Exterior	254 mm
D. Interior	202 mm
Altura	54 mm
D. Montura	0 mm
Tipo	Aire Redondo
Sello	Axial

APLICACIONES
CHEVROLET



AP4416

HD / PESADO
AIRE
SECUNDARIO

D. Exterior	162 mm
D. Interior	133.4 mm
Altura	490 mm
D. Montura	17.8 mm
Tipo	Aire Redondo
Sello	Axial

APLICACIONES
FOTON / YUTONG



AP4439

LD / LIVIANO
AIRE
PRINCIPAL

Altura	56 mm
Ancho	82 mm
Ancho 2	0 mm
Longitud	360 mm
Longitud 2	0 mm
-	-

APLICACIONES
RENAULT



AP4494

LD / LIVIANO
AIRE
PRINCIPAL

Altura	35 mm
Ancho	190 mm
Ancho 2	0 mm
Longitud	205 mm
Longitud 2	0 mm
-	-

APLICACIONES
CHERY / CHEVROLET / DAEWOO



AP4495

LD / LIVIANO
AIRE
PRINCIPAL

Altura	27 mm
Ancho	194 mm
Ancho 2	0 mm
Longitud	225 mm
Longitud 2	0 mm
-	-

APLICACIONES
CHEVROLET



AP4636

MD / MEDIANO
AIRE
PRINCIPAL

D. Exterior	260 mm
D. Interior	164 mm
Altura	405 mm
D. Montura	0 mm
Tipo	Aire Redondo
Sello	Radial

APLICACIONES
INTERNATIONAL



AP4637

MD / MEDIANO
AIRE
SECUNDARIO

D. Exterior	203 mm
D. Interior	128 mm
Altura	380 mm
D. Menor	88 mm
Tipo	Aire Redondo
Sello	Radial

APLICACIONES
INTERNATIONAL



AP46530

OTROS
AIRE
PRINCIPAL

D. Exterior	170 mm
D. Interior	95 mm
Altura	393.8 mm
D. Montaje	11.8 mm
Tipo	Aire Redondo
Sello	Axial

APLICACIONES
FORD



AP46531

OTROS
AIRE
INTERNO

D. Exterior	92.7 mm
D. Interior	70 mm
Altura	352 mm
D. Montaje	11.8 mm
Tipo	Aire Redondo
Sello	Axial

APLICACIONES
FORD



AP4862

HD / PESADO
AIRE
PRINCIPAL

D. Exterior	303 mm
D. Interior	195 mm
Altura	406 mm
D. Montura	0 mm
Tipo	Aire Redondo
Sello	Radial

APLICACIONES
INTERNATIONAL



AP4863

HD / PESADO
AIRE
SECUNDARIO

D. Exterior	253 mm
D. Interior	170 mm
Altura	390 mm
D. Menor	137 mm
Tipo	Aire Redondo
Sello	Radial

APLICACIONES
INTERNATIONAL



AP48772

LD / LIVIANO DIÉSEL
AIRE
PRINCIPAL

D. Exterior	163 mm
D. Interior	97 mm
Altura	163 mm
D. Montura	0 mm
Tipo	Aire Redondo
Sello	Radial

APLICACIONES
CHEVROLET



AP49064

HD / PESADO
AIRE
PRINCIPAL

D. Exterior	327 mm
D. Interior	148 mm
Altura	406 mm
D. Montura	0 mm
Tipo	Aire Redondo
Sello	Radial

APLICACIONES
VOLVO



AP49064SY

HD / PESADO
AIRE
SEGURIDAD

D. Exterior	168 mm
D. Interior	133 mm
Altura	440 mm
D. Montura	0 mm
Tipo	Aire Redondo
Sello	Axial

APLICACIONES
VOLVO



AP4986

HD / PESADO
AIRE
PRINCIPAL

Flujo invertido

D. Exterior	288 mm
D. Interior	172 mm
Altura	609 mm
D. Montura	15 mm
Tipo	Aire Redondo
Sello	Radial

APLICACIONES
KENWORTH



AP4M8047

OTROS
AIRE
PRINCIPAL

D. Exterior	232 mm
D. Interior	124.6 mm
Altura	319 mm
D. Montaje	0 mm
Tipo	Aire Redondo
Sello	Axial

APLICACIONES
CATERPILLAR



AP4M8048

OTROS
AIRE
INTERNO

D. Exterior	121 mm
D. Interior	92 mm
Altura	347 mm
D. Montaje	0 mm
Tipo	Aire Redondo
Sello	Axial

APLICACIONES
CATERPILLAR



AP4M9334

OTROS
AIRE
PRINCIPAL

D. Exterior	282 mm
D. Interior	172 mm
Altura	344.1 mm
D. Montaje	0 mm
Tipo	Aire Redondo
Sello	Axial

APLICACIONES
CATERPILLAR



AP5021

HD / PESADO
AIRE
PRINCIPAL

D. Exterior	277 mm
D. Interior	171 mm
Altura	392 mm
D. Montura	24.2 mm
Tipo	Aire Redondo
Sello	Axial

APLICACIONES
CHEVROLET / NISSAN



AP51250

HD / PESADO
AIRE
SECUNDARIO

D. Exterior	162 mm
D. Interior	133.4 mm
Altura	361.5 mm
D. Montura	17.8 mm
Tipo	Aire Redondo
Sello	Axial

APLICACIONES
CHEVROLET / NISSAN



AP5203

HD / PESADO
AIRE
PRINCIPAL

D. Exterior	280 mm
D. Interior	175 mm
Altura	465 mm
D. Montura	0 mm
Tipo	Aire Redondo
Sello	Radial

APLICACIONES
CHEVROLET



AP5213

HD / PESADO
AIRE
PRINCIPAL

D. Exterior	332 mm
D. Interior	175 mm
Altura	424 mm
D. Montura	0 mm
Tipo	Aire Redondo
Sello	Radial

APLICACIONES
CHEVROLET



AP5213SY

HD / PESADO
AIRE
SECUNDARIO

D. Exterior	175.6 mm
D. Interior	149.8 mm
Altura	406 mm
D. Montura	0 mm
Tipo	Aire Redondo
Sello	Radial

APLICACIONES
CHEVROLET



AP5217

HD / PESADO
AIRE
SECUNDARIO

D. Exterior	171 mm
D. Interior	130 mm
Altura	442 mm
D. Montura	0 mm
Tipo	Aire Redondo
Sello	Radial

APLICACIONES
CHEVROLET



AP524344

HD / PESADO
AIRE
PRINCIPAL

D. Exterior	318 mm
D. Interior	215 mm
Altura	420T mm
D. Montura	0 mm
Tipo	Aire Redondo
Sello	Axial

APLICACIONES
CHEVROLET



AP531

LD / LIVIANO
AIRE
PRINCIPAL

D. Exterior	240 mm
D. Interior	0 mm
Altura	36 mm
D. Montura	15 mm
Tipo	Aire Redondo
-	-

APLICACIONES
CHEVROLET



AP54100

LD / LIVIANO DIÉSEL
AIRE
PRINCIPAL

D. Exterior	134 mm
D. Interior	77 mm
Altura	280 mm
D. Montura	12 mm
Tipo	Aire Redondo
Sello	Axial

APLICACIONES
TOYOTA



AP56010

LD / LIVIANO
AIRE
PRINCIPAL

D. Exterior	200 mm
D. Interior	0 mm
Altura	144.5 mm
D. Montura	13.3 mm
Tipo	Aire Redondo
Sello	Axial

APLICACIONES
DAIHATSU



AP561

LD / LIVIANO
AIRE
PRINCIPAL

D. Exterior	239 mm
D. Interior	0 mm
Altura	39 mm
D. Montura	19 mm
Tipo	Aire Redondo
Sello	Axial

APLICACIONES
CHEVROLET



AP5627

HD / PESADO
AIRE
PRINCIPAL

D. Exterior	260 mm
D. Interior	146 mm
Altura	403 mm
D. Montura	0 mm
Tipo	Aire Redondo
Sello	Radial

APLICACIONES
CHEVROLET



AP5628

HD / PESADO
AIRE
SECUNDARIO

D. Exterior	144 mm
D. Interior	111 mm
Altura	419 mm
D. Montura	0 mm
Tipo	Aire Redondo
Sello	Radial

APLICACIONES
FORD / MERCEDES BENZ
VOLKSWAGEN



AP57MD31

HD / PESADO
AIRE
PRINCIPAL

Flujo invertido

D. Exterior	322 mm
D. Interior	214 mm
Altura	381.5 mm
D. Montura	0 mm
Tipo	Aire Redondo
Sello	Axial

APLICACIONES
MACK



AP57MD33

HD / PESADO
AIRE
PRINCIPAL

Flujo invertido

D. Exterior	322 mm
D. Interior	214 mm
Altura	588 mm
D. Montura	0 mm
Tipo	Aire Redondo
Sello	Axial

APLICACIONES
FREIGHTLINER / MACK



AP5A500

HD / MEDIANO
AIRE
PRINCIPAL

D. Exterior	235 mm
D. Interior	129 mm
Altura	303.5 mm
D. Montura	22.5 mm
Tipo	Aire Redondo
Sello	Axial

APLICACIONES
HYUNDAI



AP5H100

MD / MEDIANO
AIRE
PRINCIPAL

D. Exterior	196 mm
D. Interior	132 mm
Altura	292 mm
D. Montura	0 mm
Tipo	Aire Redondo
Sello	Radial

APLICACIONES
HYUNDAI



AP603A

LD / LIVIANO
AIRE
PRINCIPAL

Altura	46 mm
Ancho	195 mm
Ancho 2	0 mm
Longitud	228 mm
Longitud 2	0 mm
-	-

APLICACIONES
FORD



AP62010

MD / MEDIANO
AIRE
PRINCIPAL

D. Exterior	198 mm
D. Interior	86 mm
Altura	146 mm
D. Montura	0 mm
Tipo	Aire Redondo
Sello	Axial

APLICACIONES
TOYOTA



AP626

LD / LIVIANO
AIRE
PRINCIPAL

D. Exterior	280 mm
D. Interior	216 mm
Altura	56 mm
D. Montura	0 mm
Tipo	Aire Redondo
Sello	Axial

APLICACIONES
MAZDA



AP6261
LD / LIVIANO
AIRE
PRINCIPAL

D. Exterior	280 mm
D. Interior	216 mm
Altura	65 mm
D. Montura	0 mm
Tipo	Aire Redondo
Sello	Axial

APLICACIONES
MAZDA



AP62636
HD / PESADO
AIRE
PRINCIPAL

D. Exterior	255 mm
D. Interior	108 mm
Altura	145 mm
D. Montura	0 mm
Tipo	Aire Redondo
Sello	Axial

APLICACIONES
INTERNATIONAL



AP6293
LDD / LIVIANO DIÉSEL
AIRE
PRINCIPAL

Altura	54 mm
Ancho	206 mm
Ancho 2	0 mm
Longitud	162 mm
Longitud 2	0 mm
-	-

APLICACIONES
CHEVROLET



AP63680
LD / LIVIANO
AIRE
PRINCIPAL

D. Exterior	134 mm
D. Interior	81 mm
Altura	166 mm
D. Montura	0 mm
Tipo	Aire Redondo
Sello	Radial

APLICACIONES
HONDA



AP6A701
HD / PESADO
AIRE
PRINCIPAL

D. Exterior	268.8 mm
D. Interior	156.5 mm
Altura	333 mm
D. Montura	24.5 mm
Tipo	Aire Redondo
Sello	Axial

APLICACIONES
HYUNDAI



AP7242
MD / MEDIANO
AIRE
PRINCIPAL

D. Exterior	230 mm
D. Interior	120 mm
Altura	281 mm
D. Montura	0 mm
Tipo	Aire Redondo
Sello	Radial

APLICACIONES
MITSUBISHI



AP7242P
MD / MEDIANO
AIRE
PRINCIPAL

D. Exterior	182 mm
D. Interior	94 mm
Altura	246 mm
D. Montura	0 mm
Tipo	Aire Redondo
Sello	Axial

APLICACIONES
MITSUBISHI



AP78020
MD / MEDIANO
AIRE
PRINCIPAL

D. Exterior	232 mm
D. Interior	132 mm
Altura	262 mm
D. Montura	0 mm
Tipo	Aire Redondo
Sello	Radial

APLICACIONES
HINO / TOYOTA



AP78090
MD / MEDIANO
AIRE
PRINCIPAL

D. Exterior	232 mm
D. Interior	132 mm
Altura	212 mm
D. Montura	0 mm
Tipo	Aire Redondo
Sello	Radial

APLICACIONES
HINO



AP78605
HD / PESADO
AIRE
PRINCIPAL

D. Exterior	350 mm
D. Interior	209 mm
Altura	370 mm
D. Montura	13 mm
Tipo	Aire Redondo
Sello	Axial

APLICACIONES
VOLVO



AP7C000
LD / LIVIANO
AIRE
PRINCIPAL

D. Exterior	322 mm
D. Interior	214 mm
Altura	436 mm
D. Montura	22.4 mm
Tipo	Aire Redondo
Sello	Axial

APLICACIONES
HYUNDAI



AP7N1225
OTROS
AIRE
PRINCIPAL

D. Exterior	263.5 mm
D. Interior	154.5 mm
Altura	236.5 mm
D. Montaje	18.6 mm
Tipo	Aire Redondo
Sello	Axial

APLICACIONES
CATERPILLAR



AP8040
LD / LIVIANO
AIRE
PRINCIPAL

D. Exterior	239 mm
D. Interior	110 mm
Altura	146 mm
D. Montura	0 mm
Tipo	Aire Redondo
Sello	Axial

APLICACIONES
DAIHATSU



AP8054
LDD / LIVIANO DIÉSEL
AIRE
PRINCIPAL

D. Exterior	155 mm
D. Interior	89.4 mm
Altura	290 mm
D. Montura	25 mm
Tipo	Aire Redondo
Sello	Axial

APLICACIONES
FOTON/GOLDEN DRAGON/JAC,
JIMBEI/KING LONG/TOYOTA



AP812105
HD / PESADO
AIRE
PRINCIPAL

D. Exterior	231 mm
D. Interior	149 mm
Altura	341 mm
D. Montura	19.8 mm
Tipo	Aire Redondo
Sello	Axial

APLICACIONES
HINO / NISSAN / FOTON



AP8280
HD / PESADO
AIRE
PRINCIPAL

D. Exterior	174 mm
D. Interior	106 mm
Altura	423 mm
D. Montura	0 mm
Tipo	Aire Redondo
Sello	Radial

APLICACIONES
IVECO



AP84457
HD / PESADO
AIRE
PRINCIPAL

D. Exterior	266 mm
D. Interior	168 mm
Altura	490 mm
D. Montura	0 mm
Tipo	Aire Redondo
Sello	Europiclon

APLICACIONES
MERCEDES BENZ / SCANIA



AP84457SY
HD / PESADO
AIRE
PRINCIPAL

D. Exterior	155 mm
D. Interior	137 mm
Altura	509 mm
D. Montura	0 mm
Tipo	Aire Redondo
Sello	Radial

APLICACIONES
MERCEDES BENZ / SCANIA



AP85051
MD / MEDIANO
AIRE
PRINCIPAL

D. Exterior	174 mm
D. Interior	98 mm
Altura	258 mm
D. Montura	0 mm
Tipo	Aire Redondo
Sello	Radial

APLICACIONES
JAC



AP8A900
MD / MEDIANO
AIRE
PRINCIPAL

D. Exterior	280 mm
D. Interior	150 mm
Altura	446 mm
D. Montura	0 mm
Tipo	Aire Redondo
Sello	Radial

APLICACIONES
HYUNDAI



AP95600906
HD / PESADO
AIRE
PRINCIPAL

Flujo invertido

D. Exterior	224.5 mm
D. Interior	147 mm
Altura	737 mm
D. Montura	0 mm
Tipo	Aire Redondo
Sello	Axial

APLICACIONES
CHEVROLET



AP99322
LD / LIVIANO
AIRE
PRINCIPAL

Altura	47 mm
Ancho	232 mm
Ancho 2	123 mm
Longitud	306 mm
Longitud 2	0 mm
-	-

APLICACIONES
CHEVROLET



AP9961
HD / PESADO
AIRE
PRINCIPAL

D. Exterior	331 mm
D. Interior	221 mm
Altura	410 mm
D. Montura	0 mm
Tipo	Aire Redondo
Sello	Radial

APLICACIONES
VOLVO



AP99727
LD / LIVIANO
AIRE
PRINCIPAL

Altura	40 mm
Ancho	210 mm
Ancho 2	0 mm
Longitud	267 mm
Longitud 2	193 mm
-	-

APLICACIONES
CHEVROLET



AP9S001

LDD / LIVIANO DIÉSEL

AIRE

PRINCIPAL

D. Exterior	135.2 mm
D. Interior	72.2 mm
Altura	230 mm
D. Montura	0 mm
Tipo	Aire Redondo
Sello	Radial

APLICACIONES
NISSAN



APC010

LDD / LIVIANO DIÉSEL

AIRE

PRINCIPAL

D. Exterior	215 mm
D. Interior	123 mm
Altura	175 mm
D. Montura	0 mm
Tipo	Aire Redondo
Sello	Radial

APLICACIONES
FORD / MAZDA / TOYOTA



APC20325/2

HD / PESADO

AIRE

PRINCIPAL

D. Exterior	197 mm
D. Interior	108 mm
Altura	373.5 mm
D. Montura	9.6 mm
Tipo	Aire Redondo
Sello	Axial

APLICACIONES
IVECO / FOTON / MERCEDES BENZ
VOLKSWAGEN



APC20325/2SY

MD / MEDIANO

AIRE

SECUNDARIO

D. Exterior	95 mm
D. Interior	89.6 mm
Altura	374 mm
D. Montura	16.6 mm
Tipo	Aire Redondo
Sello	Axial

APLICACIONES
FORD / MERCEDES BENZ / FOTON
VOLKSWAGEN



APC20500

MD / MEDIANO

AIRE

PRINCIPAL

D. Exterior	196 mm
D. Interior	115 mm
Altura	402 mm
D. Montura	0 mm
Tipo	Aire Redondo
Sello	Radial

APLICACIONES
AGRALE



APC20500SY

MD / MEDIANO

AIRE

SECUNDARIO

D. Exterior	105 mm
D. Interior	87 mm
Altura	378 mm
D. Montura	0 mm
Tipo	Aire Redondo
Sello	Radial

APLICACIONES
AGRALE



APC23610

MD / MEDIANO

AIRE

PRINCIPAL

D. Exterior	220 mm
D. Interior	125 mm
Altura	402 mm
D. Montura	0 mm
Tipo	Aire Redondo
Sello	Radial

APLICACIONES
AGRALE



APC23610SY

MD / MEDIANO

AIRE

SECUNDARIO

D. Exterior	114 mm
D. Interior	100 mm
Altura	389 mm
D. Menor	0 mm
Tipo	Aire Redondo
Sello	Radial

APLICACIONES
AGRALE



APC301251

LD / LIVIANO

AIRE

PRINCIPAL

Altura	41.5 mm
Ancho	208 mm
Ancho 2	0 mm
Longitud	287.5 mm
Longitud 2	0 mm
-	-

APLICACIONES
CHEVROLET



APCA502

OTROS

AIRE

PRINCIPAL

D. Exterior	305 mm
D. Interior	191 mm
Altura	471.5 mm
D. Montaje	17.5 mm
Tipo	Aire Redondo
Sello	Axial

APLICACIONES
ALLIS CHALMERS



APCA502SY

OTROS

AIRE

INTERNO

D. Exterior	186 mm
D. Interior	156 mm
Altura	456 mm
D. Montaje	16.7 mm
Tipo	Aire Redondo
Sello	Axial

APLICACIONES
ALLIS CHALMERS



APG4800

LDD / LIVIANO DIÉSEL

AIRE

PRINCIPAL

D. Exterior	148.9 mm
D. Interior	72.7 mm
Altura	332.5 mm
D. Menor	0 mm
Tipo	Aire Redondo
Sello	Axial

APLICACIONES
NISSAN



APG6000

LDD / LIVIANO DIÉSEL
AIRE
PRINCIPAL

D. Exterior	95 mm
D. Interior	74 mm
Altura	267 mm
D. Montura	0 mm
Tipo	Aire Redondo
Sello	Radial

APLICACIONES
KIA

APH100

LDD / LIVIANO DIÉSEL
AIRE
PRINCIPAL

D. Exterior	201 mm
D. Interior	125 mm
Altura	188.5 mm
D. Montura	15 mm
Tipo	Aire Redondo
Sello	Axial

APLICACIONES
HYUNDAI / KIA

APL300

HD / PESADO
AIRE
PRINCIPAL

D. Exterior	174.5 mm
D. Interior	134.5 mm
Altura	169.9 mm
D. Corona	205.6 mm
Tipo	Aire Redondo
Sello	Axial

APLICACIONES
MITSUBISHI

APSL40A

LD / LIVIANO
AIRE
PRINCIPAL

Altura	37 mm
Ancho	146 mm
Ancho 2	0 mm
Longitud	265 mm
Longitud 2	0 mm
-	-

APLICACIONES
KIA

APSL5013Z40A

MD / MEDIANO
AIRE
PRINCIPAL

D. Exterior	155 mm
D. Interior	89.4 mm
Altura	361 mm
D. Montura	25 mm
Tipo	Aire Redondo
Sello	Axial

APLICACIONES
MAZDA

KIT AP80006

MEDIANO

Aire	AP80006
Aire Seguridad	AP80006SY
Sello	Radial
-	-
-	-
-	-

APLICACIONES
MITSUBISHI FUSO FA 9.0 / FI 10.4 2017>
MOTOR 4D37-125



ES JUSTO
LO QUE NECESITAS



**SOLUCIONES EN FILTRACIÓN
PARA TRANSPORTE MEDIANO**

Encuétranos como **Filtros Partmo** / f / @ / in / ▶ /

partmo.com



CO-SC-CER896120

TIPS DE INSTALACIÓN SISTEMA DE LUBRICACIÓN

ENTRADAS Y SALIDAS DE UN MOTOR

Un motor de combustión interna es un componente mecánico que recibe múltiples entradas para realizar una operación normal; el aceite lubricante, el combustible, el aire, el agua o los refrigerantes, y la energía eléctrica son componentes que ingresan para realizar una combustión en el motor, disipando calor, gases de la combustión y generando energía mecánica traducida en trabajo o movimiento.

NECESIDAD DE LA LUBRICACIÓN

Este movimiento de partes móviles como rodamientos, engranajes y sistemas hidráulicos, que generan la potencia en un motor, por pulidas que se encuentran, son superficies que están enredadas y deben ser separadas por una fina película de aceite para evitar que entren en contacto, y por rozamiento eleven su temperatura hasta fundirse.

Estas separaciones entre las partes móviles de un motor se miden en micras, la milésima parte de un milímetro. Así encontramos separaciones entre 0.1 a 1 micra en rodamientos de bola, de 50 a 250 micras en actuadores, de 40 a 60 micras en partes móviles en movimiento en un motor a gasolina o de ciclo otto y de 60 a 80 micras en un motor de ciclo diésel.

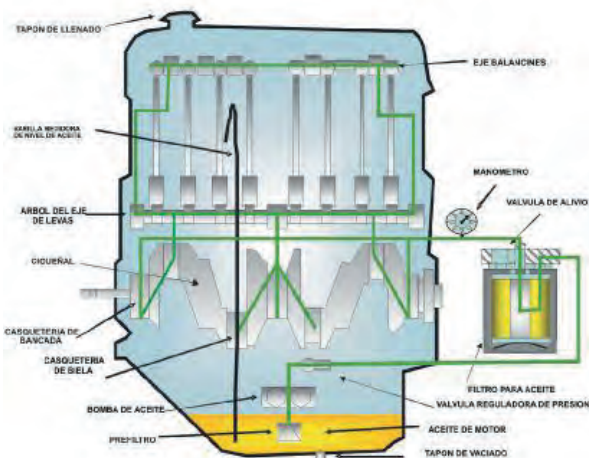

Un motor siempre mantendrá aceite en sus partes móviles, por ello la capacidad en un motor pequeño puede ser de 4/4 de aceite, pero en el cambio solo requerir algo más de 3/4, pero no su capacidad completa. En un motor diésel es más evidente, pues una vez hecho el cambio de aceite con el encendido este se torna oscuro al circular el aceite de carga inicial que permanece en las galerías del motor luego del drenaje del mismo.

NECESIDAD DE LA FILTRACIÓN

La contaminación del aceite al interior del motor puede provenir de la atmosfera o de la operación misma del motor, entre otras por:

1. Polvo del ambiente que ingresa sigilosamente a las cámaras de combustión ante ausencia de sellos en los filtros de aire, mal estado o fallas en la hermeticidad de las carcasas del filtro de aire, mangueras o abrazaderas en el sistema de admisión de aire en mal estado, generan la inclusión de la sílice como un contaminante altamente abrasivo que de manera acelerada desgasta anillos, cilindros o camisas ocasionando el desgaste prematuro al equipo.

2. Otros contaminantes propios de la construcción, especialmente en motores diésel nuevos o recién reparados del maquinado, herrumbre por oxidación, partículas de desgaste de sellos, rodamientos y engranajes, arenas de fundición, partículas de soldadura, pintura y hollín.

3. Agua, proveniente de la condensación, disolución en el combustible (Diésel o gasolina), de fugas de refrigerante en el sistema de enfriamiento, agua libre proveniente de los tanques de combustible y del motor que entra por disolución en el combustible y de ausencia de sellos de empaquetaduras de la tapa del motor, la culata, o el carter.

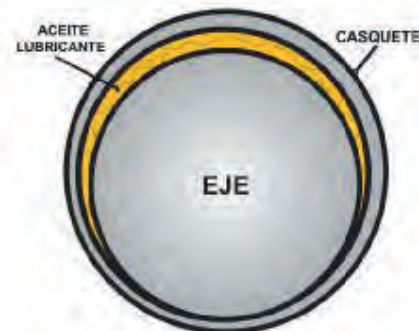

4. Lodos generados por la deficiente calidad de los aceites, degradación de los aditivos, excesivo uso del aceite y filtros, recalentamiento del motor y deficientes prácticas de mantenimiento.

En la medida en que estos contaminantes relacionados anteriormente no se controlen para evitar que ingresen al motor o se generen de manera normal, desproporcionada o anormal, los filtros son un requerimiento para proteger el equipo y preservar la durabilidad del mismo.

No cumplir los estándares de limpieza requeridos en este sistema llegaría a ocasionar una operación lenta e ineficiente con desgaste excesivo y fallas prematuras de los componentes móviles del motor.

La lubricación hidrodinámica empieza con el arranque del motor, en velocidad de marcha mínima, las partes móviles flotan permanentemente sobre una delgada película de aceite nunca entrando en contacto entre sí. Un cojinete de un cigüeñal cuyo apoyo es de 50 mm de diámetro puede llegar a tener una holgura normal de 75 micras y estará permanentemente lubricado a máxima presión permitiendo cargas máximas de trabajo y movimiento con muy poco o ningún desgaste.

Un principio de filtración consecuente con las separaciones establece que los niveles de limpieza de estos aceites requieren retener partículas nocivas al motor es un mínimo del 50% del tamaño nominal de las separaciones, es decir si en un motor a gasolina, estas separaciones están en el rango de 40 a 60 micras, la filtración nominal ha de ser de 25 micras e igualmente en un motor diésel no mayor de 35 micras.

En algunos motores modernos diésel y gasolina la filtración de aceite es tan exigente bajo este principio que se requiere retirar una granulometría menor a las 10 micras nominales en filtros de aceite de motor y de 2 micras en filtros de aceite de flujo parcial o en derivación.

LOS SISTEMAS DE LUBRICACIÓN Y LA FILTRACIÓN DEL ACEITE

Con el avance de los motores y las exigencias de los mismos se incorpora un sistema de lubricación que contiene por primera vez un filtro para aceite de flujo parcial, hacia el año 1927.

A medida que avanzan las aceites, los materiales con las cuales se fabrican los motores, las exigencias de los equipos y el ambiente, las medias filtrantes y los aceites y combustibles avanzan de igual manera los sistemas de lubricación y filtración, modernizando los sistemas de lubricación y su filtración. A continuación, se describen algunos de los sistemas de lubricación y filtración con las cuales estamos familiarizados los fabricantes de filtros.

SISTEMA DE LUBRICACIÓN CON FILTRACIÓN DE FLUJO PARCIAL

Este sistema de lubricación fue el primero en incorporarse a los motores; el aceite que succiona la bomba a través de un prefiltro contenido en el Carter es llevado a través de una galería principal, donde deriva un 10% del aceite hacia un filtro de flujo parcial, para retener diminutas partículas con una granulometría nominal de 5 a 10 micras hacia arriba antes de volver al carter. El restante 90% del flujo del aceite que impulsa la bomba pasa a lubricar las partes móviles del motor, con un agravante es un aceite sin filtrar.

Este sistema de lubricación con sistema único de filtración de flujo parcial se encuentra en decadencia y solo es utilizado en ciertos equipos antiguos como Fiat Polsky, Yugo y Zastava en presentaciones de unidad sellada, dejando atrás aplicaciones de múltiples marcas que contenían filtros del tipo elemento intercambiable de flujo parcial.

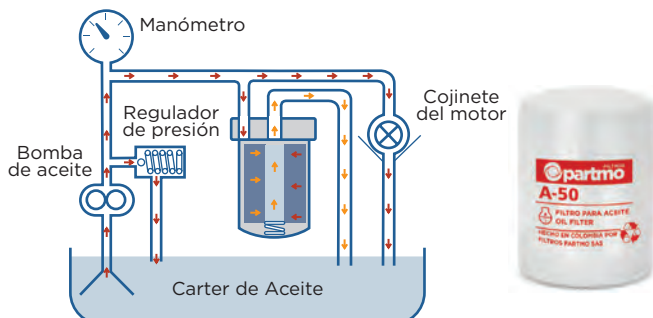

SISTEMA DE LUBRICACIÓN CON FILTRACIÓN DE FLUJO COMPLETO

En este sistema, el 100% del aceite que impulsa la bomba, atraviesa una primera etapa de filtración donde se retiran aquellos contaminantes con una granulometría nominal de 25 micras, del aceite que va a lubricar las partes móviles del motor (con un 90% del flujo). El restante 10% se desvía hacia un filtro de flujo parcial donde se separan contaminantes de una granulometría nominal de 5-10 micras (aceite que regresa al carter).

Con la inclusión de los sistemas de flujo combinado, flujo completo y flujo parcial, en los vehículos pesados se logró reducir de manera sustancial el desgaste de cojinetes de biela y bancada, aumentando la durabilidad de los equipos diésel por encima de los 850.000 kilómetros.

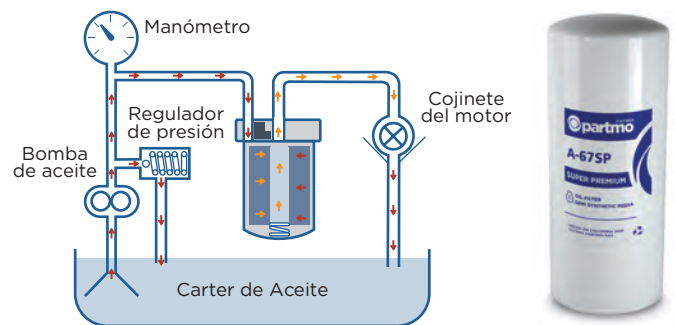

SISTEMA DE LUBRICACIÓN CON FILTRACIÓN DE FLUJO COMBINADO, FLUJO COMPLETO Y FLUJO PARCIAL

En este sistema el 100% del aceite que impulsa la bomba atraviesa una primera etapa de filtración donde se retira aquellos contaminantes con una granulometría nominal de 25 micras, aceite que va a lubricar, con un 90% del flujo, las partes móviles del motor. El restante 10% se desvía hacia un filtro de flujo parcial donde se separan contaminantes de una granulometría nominal de 5-10 micras, aceite que regresa al carter. Con la inclusión de los sistemas de flujo combinado, flujo completo y flujo parcial, en los vehículos pesados se logró reducir de manera sustancia el desgaste de cojinetes de biela y bancada, aumentando la durabilidad de los equipos diésel por encima de los 850.000 kilómetros.

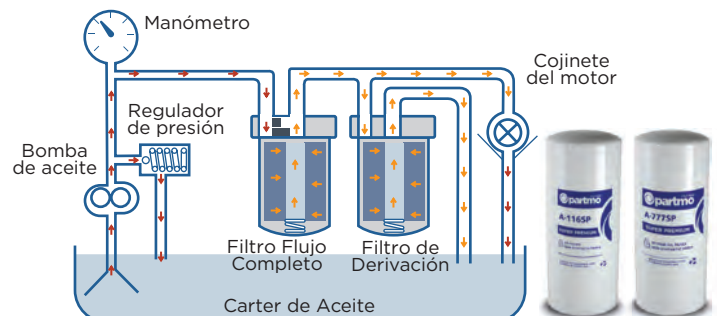

ACEITE

Hasta hace una década estos sistemas de filtración de dos unidades filtrantes fue el más efectivo en los vehículos diésel pesado y aun hoy en día, se construyen motores y es aplicado a la mayor parte de los vehículos diésel, desde busetas hasta tracto camiones, al igual que en la mayor parte de los equipos de minería y construcción existentes.

SISTEMA DE LUBRICACIÓN CON FILTRACIÓN DE FLUJO DUAL, FLUJO COMPLETO Y FLUJO PARCIAL

En la carrera de hacer más cortos los tiempos de mantenimiento de cambio de aceite y filtros en los vehículos de trabajo pesado, los fabricantes de motores crean los filtros de flujo dual, flujo completo y flujo parcial en una sola unidad filtrante, extendiendo la vida de los motores hasta los 1.2 millones de kilómetros.

En este sistema el 100% del aceite que impulsa la bomba, en filtros duales en serie, atraviesa una primera etapa de filtración donde se retira aquellos contaminantes con una granulometría nominal de 25 micras. De este aceite filtrado se desvía hacia una segunda etapa de filtración de flujo parcial un 12% del flujo del aceite aproximadamente donde se separan contaminantes de una granulometría nominal de 5-10 micras, aceite que regresa al carter.

En filtros duales en paralelo, el aceite ingresa al filtro y se distribuye el 90% por el medio filtrante de flujo completo, el cual se direcciona a lubricar el motor; y el restante 10% se filtra por el medio de flujo parcial antes de regresar al carter.

Este sistema se aplica a gran cantidad de equipos pesados modernos que permiten intervalos de servicio extendido, con mayor tiempo de actividad del vehículo, reducción de costos de mantenimiento y reducción de costos por disposición de residuos al disponer de menos volumen de aceite y solo una unidad con filtración de flujo completo y flujo parcial.

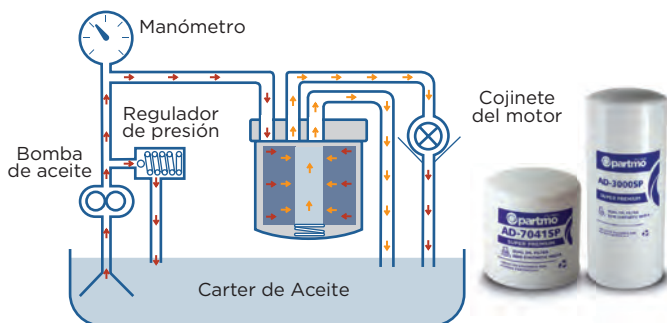

SISTEMA DE LUBRICACIÓN CON FILTRACIÓN DE FLUJO VENTURY O DE ALTA VELOCIDAD O ALTA ACELERACIÓN FLUJO COMPLETO Y FLUJO PARCIAL

El 100% del aceite impulsado por la bomba llega al filtro y se distribuye por dos vías. Aproximadamente un 10% del flujo del aceite pasa a través de un medio filtrante de flujo parcial de una

porosidad nominal de 5-10 micras antes de llegar a la garganta dispuesta como conector de salida y un 90% del flujo del aceite pasa a través de un medio filtrante de porosidad nominal de 25 micras, alto flujo que llega a la garganta generando la succión requerida para hacer la mezcla del flujo completo y flujo parcial para la lubricación de las partes móviles del motor. Con este sistema se logra la mejor filtración disponible hasta el momento en equipos diésel pesados, con la mayor durabilidad, extendiendo mantenimientos a primera reparación que puede llegar a los 1.6 millones de kilómetros, como en los motores rojos o ISX y ISM de Cummins.

Poco a poco el sistema de filtración dual se está reemplazando por unidades filtrantes con sistema de flujo de alta velocidad o alta aceleración, comúnmente llamados sistemas ventury los cuales han llegado a incrementar la vida útil de los motores diésel de trabajo pesado al doble de vida del obtenido con filtros del tipo combinado flujo completo y flujo parcial, logrando combinar la filtración fina nominal de 10 micras con la filtración de motor nominal de 25 micras.



SISTEMA DE LUBRICACIÓN CON FILTRACIÓN DE CENTRIFUGACIÓN DE HOLLÍN

Ante las exigencias ambientales en reducir más las emisiones atmosféricas permitidas a los fabricantes de motores, fue necesario cambiar los diseños atrasando más la inyección del combustible y aumentando más el nivel de hollín en los aceites lubricantes.

Estos finos contaminantes de hollín generan desgaste en el sistema de válvulas y guías de válvulas, taponamiento prematuro de filtros para aceite, desgaste de rodamientos y generación de material sedimentado en el aceite. Hacer el trabajo de atrapar el contaminante más fino de hollín generado para ampliar los intervalos de cambio de filtros y aceites, reducir los costos de mantenimiento, aumentar la vida útil de los equipos, entre otros es función de los llamados filtros centrifugos.

En este sistema de lubricación del aceite con el sistema de filtración que se incorpore, sea de flujo completo, flujo combinado, flujo dual o flujo ventury, una pequeña proporción se deriva hacia un filtro centrifugo, el cual mediante la disposición de difusores dispuestos de manera secuencial hacen que pequeñas partículas golpeen la carcasa del filtro y se vayan aglomerando formando lodos que se mantiene dentro del filtro. En la medida en que el hollín se vaya incorporando en el aceite este va pasando en pequeñas proporciones hacia el filtro centrifugo quedando atrapado, sin afectar de manera alguna el ciclo normal de lubricación hacia el motor.

Estos filtros centrífugos pueden ser instalados como equipo original, equipo de norma o adicional en motores diésel, transmisiones y aplicaciones industriales de todo el mundo, que incluyen motores diésel de 18 litros o más, de 450 caballos de potencia o más y de 335 kw o más, permitiendo reducir costos de mantenimiento, extender cambios de filtros y aceites, logrando mayor durabilidad de los equipos y superando de manera amplia las regulaciones ambientales que tengan lugar para equipos diésel modernos.

Estos filtros centrífugos aumentan la vida útil de los filtros del sistema de lubricación, extienden los periodos de cambio del aceite y filtros, brindan una protección extra al desgaste normal del motor y reduce los periodos de mantenimiento de los equipos diésel protegiendo el ambiente al reducir aún más las emisiones de contaminantes nocivos a la atmósfera.

SISTEMA DE LUBRICACIÓN CON FILTRACIÓN DE GASES DEL CARTER

Un filtro estático y absorbente provisto hoy en día en algunos motores como filtro original es incorporado a los sistemas de recirculación de gases del carter. Este sistema retira el 99% de la niebla del aceite y de las partículas que se encuentran en suspensión en los gases de recirculación separando gotitas de aceite de los gases 'blow-by' de aireación del carter y canalizando humos limpios hacia el depurador del aire en sistemas cerrados o retirando cualquier fuga de neblina de aceite hacia la atmósfera en sistemas abiertos.

Las conexiones de un filtro de recirculación de gases del carter puede llevar los gases limpios directamente al sistema de admisión del motor ó a la admisión antes del filtro del aire, asegurando su filtración.

El aceite almacenado en el colector del filtro de recirculación pueden conectarse al carter siempre y cuando este no contenga en el combustible, contaminantes de sulfuro o productos químicos alógenos, en tal caso, es recomendable recoger tales residuos y disponerlos de manera controlada en los lubricentros.

Estos sistemas de filtración son utilizados en equipos estacionarios en cuartos de máquinas como equipo original, pero pueden ser instalados como equipo de norma en motores de vehículos diésel de tipo pesado, cuando así sea exigible o cuando se desea preservar el ambiente y darle una protección adicional al motor usando gases de recirculación debidamente filtrados.

Otros sistemas de filtración de gases del carter son los llamados sistemas de ventilación abiertos instalados en motores como equipo original de norma, los cuales han sido habilitados para eliminar el 99% del goteo, reducir en un 95% el aerosol de los gases 'blow-by' y eliminar el 100% de los humos.

Los sistemas de ventilación abiertos pueden utilizarse en motores de equipos pesados de menor desplazamiento hasta 12 pies cúbicos por minuto, para mayores de 12 pies cúbicos se recomienda utilizar sistemas de recirculación de gases del carter cerrados.

LA VÁLVULA REGULADORA DE PRESIÓN

En todos los sistemas de lubricación la bomba del aceite mantiene la presión de la línea de lubricación en un rango máximo de 80 psi (libras por pulgada cuadrada) en motores diésel o de 60 psi en motores a gasolina, mediante la válvula reguladora de presión situada a la salida de la bomba, regulando con esta válvula la presión a velocidades altas o cuando el aceite esta frio o viscoso. Una bomba de aceite nueva esta diseñada para durar el tiempo de operación entre cada reparación mayor, lo cual en algunos modelos de carros y camiones livianos es de aproximadamente 240 mil kilómetros, pero al igual que cualquier componente mecánico, la bomba del aceite esta sujeta a desgaste, más aun, considerando que este componente tiene un mayor desgaste que otros componentes del motor, ya que es el único, junto a la válvula reguladora de presión, que trabajan con el lubricante sin filtrar.

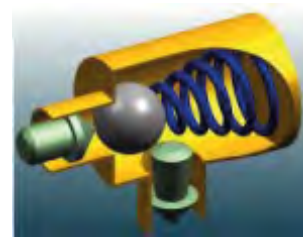

Es norma cambiar la bomba del aceite, y con ella las válvulas de alivio y la válvula reguladora de presión, en el momento de la reparación, debido a que instalar una bomba nueva es más rápido, fácil y menos riesgoso que cambiar componentes o adoptar practicas no recomendables como calzar las válvulas reguladoras de presión.

No acepte de ninguna manera que la válvula reguladora de presión sea calzada o reparada, esto puede generarle cambios de las condiciones operacionales del sistema de lubricación los cuales deben trabajar a presiones de 40-60 psi en un motor a gasolina y de 60-80 psi en un motor diésel, valores que son alterados a rangos desconocidos, que pueden tener consecuencias funestas, cuando se opta por calzar estos elementos de la bomba de aceite.

Reemplazar componentes de una bomba de doble engranaje o de bulones o aspas, no puede restaurar la tolerancia entre estos ni compensar su desgaste. Rayaduras profundas o canales que se produzcan a los lados del alojamiento producen fugas de aceite reduciendo la capacidad de la bomba para mover el aceite, desgastes en el embolo de la válvula de alivio o en los émbolos de la válvula reguladora de presión puede generar atascamientos que impiden que el sistema regule la presión y pueda llevar está a más de 500 psi, liberándola por el componente más débil, el filtro, antes de volver a su posición de trabajo, razón por la cual equivocadamente se cuestiona la calidad del filtro para aceite, cuando las fallas son derivadas de prácticas deficientes en el mantenimiento o en desgastes excesivos de los componentes de la bomba de aceite.

Cuando esta válvula reguladora de presión se atasca, se mantiene en posición cerrada, esta lenta para abrirse o se encuentra calzada puede llevar a elevar drásticamente la presión de la línea de lubricación, hacienda que los filtros pueden estallarse o desgrafarse, los empaques del filtro

expulsarse, o los tubos centrales del filtro colapsarse generando pérdida parcial o total del aceite lubricante con daños inmediatos y costosos.

LA VÁLVULA DE ALIVIO

Igualmente en la base del filtro del aceite o en el filtro, los sistemas de lubricación, a excepción del sistema de flujo parcial, llevan una válvula de alivio para dar paso de aceite sin filtrar una vez el medio filtrante se sature o se tapone. Las válvulas de alivio en los motores están calibradas para las necesidades del equipo; estas operan según el equipo o el filtro en rangos de 8 psi a 36 psi, valor representado en la máxima presión diferencial entre la entrada y la salida al paso por el medio filtrante que estaría en capacidad de soportar el filtro antes de abrirse y dar paso a aceite sin filtrar hacia el motor.

Cuando una válvula de alivio del motor opera anormalmente puede generar que al atascarse en posición cerrada, el tubo central de la unidad filtrante se colapse al soportar toda la presión del flujo de la bomba el medio filtrante, igualmente sucede cuando de manera repentina existe un cambio de presión al atascarse la válvula reguladora de presión. Una válvula atascada en posición abierta, aunque mantiene lubricado el motor, lo hace dejando pasar 100% el aceite sin filtrar causando serios daños de desgaste prematuro a las partes móviles del motor.

BAJA PRESIÓN DEL ACEITE

A menudo se encuentra que el equipo muestre una baja presión del aceite y se asuma que el filtro es el componente que genera la falla en el sistema. Una caída de presión puede tener múltiples causas que la generen; Puede ser que el equipo tenga un desgaste excesivo en los cojinetes de biela o de bancada, por tiempo de servicio o después de una deficiente reparación; por ejemplo, colocar casquetería estándar para un cigüeñal rectificado. Una tolerancia desviada de 0.001 puede reducir la presión del aceite hasta un 20%; igualmente ocurre con excesos de las tolerancias del eje de levas y sus apoyos, y las tolerancias entre los componentes de la bomba.

Una baja presión es producto de: fugas de aceite; entre la bomba y el motor o en las galerías; válvulas reguladoras de presión, atascadas en posición abierta o armadas al revés; un tubo recolector del aceite de la bomba en el carter que este suelto o mal colocado, un bajo nivel de aceite en el carter un aceite poco viscoso o muy fino para el desgaste del motor o fugas de agua o refrigerante al motor. Un cambio de filtro en un sistema con fallas de componentes del motor puede mostrar falsas apreciaciones de corrección de la falla al operar con una unidad en su mínima restricción, pero esto no es garantía de eliminar la causa real del problema de la baja presión del aceite.

LA FILTRACIÓN EN LOS MOTORES DIÉSEL

En un principio los motores diésel, no usaban filtros para aceite, la lubricación no era problema y los motores rodaban sin ninguna protección adicional al lubricante.

Con el avance de los motores diésel, las holguras entre los anillos y los cilindros fue cerrándose, obligando a los fabricantes de motores a incorporar filtros en derivación para hacer una limpieza parcial del aceite. Estos filtros fueron las primeras

unidades filtrantes de flujo parcial incorporados en los motores en el año 1927.

1. FILTRACIÓN DE FLUJO PARCIAL

En este sistema un 10% del aceite se desviaba hacia el filtro de flujo parcial, allí el aceite se filtraba muy fino, entre 5 y 10 micras de tamaño de poro nominal, para luego llevar el fluido ultrafino al cárter; el 90% restante del aceite lubricaba el motor, con un agravante, era un aceite sin filtrar. En un principio estos filtros fueron de elemento y años más tarde evolucionaron como unidades selladas enroscables del tipo intercambiable.

Sistema de derivación (flujo parcial)

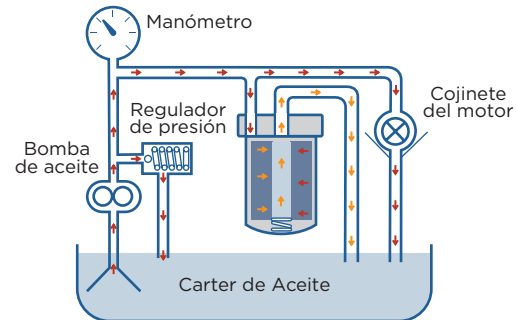

2. FILTRACIÓN DE FLUJO COMPLETO

A medida que avanzaba la tecnología de los motores diésel, avanzaban los métodos de la lubricación y la filtración incorporando los filtros de flujo completo para el año 1943. En el método de flujo completo el 100% del aceite que impulsa la bomba pasa por el filtro antes de llegar al motor, el cual con una porosidad nominal de 25 a 30 micras filtra el aceite lubricante antes de lubricar las partes móviles. En este método realmente se requiere un medio filtrante de una porosidad mayor para asegurar una alta tasa de flujo del aceite que el filtro de flujo parcial. El filtro de flujo completo retiene permanentemente partículas de mayor tamaño, con esta porosidad mayor se obtenía una filtración media con un alto flujo y una baja restricción o pérdida de carga para la lubricación del motor.

Sistema de flujo completo

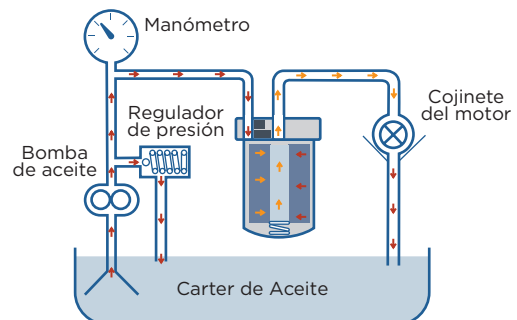

3. FILTRACIÓN DE FLUJO COMBINADO, FLUJO COMPLETO Y FLUJO PARCIAL

En los motores diésel, buscando una filtración más efectiva y una longevidad de los equipos se incorporaron los filtros combinados, es decir un filtro de flujo completo con un filtro de flujo parcial. Este método asegura que un equipo pudiera

ser reparado totalmente alrededor de los 850.000 kilómetros, recorrido muy superior al de los 350.000 a 450.000 kilómetros que sostenían los equipos anteriores.

Sistema de flujo completo / derivación

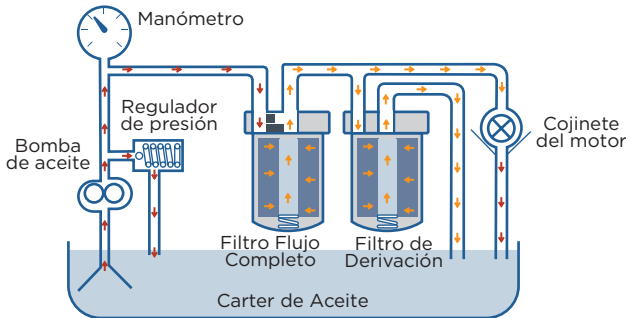

El filtro de flujo parcial, como su nombre lo indica, tomaba una parte del flujo, entre un 5% y 10% del aceite filtrado por el flujo completo, lo filtraba con una porosidad entre 5 a 10 micras, se obtenía una filtración muy fina, con muy bajo flujo y una alta restricción para lograr un aceite súper limpio y llegar a mezclarse con el aceite del cárter protegiendo más componentes como la bomba de aceite.

En la base de este filtro generalmente tiene un orificio de control de flujo, garantizando que la presión diferencial del sistema se mantenga y que el flujo del aceite se distribuya en las proporciones establecidas por el fabricante del motor, y así se asegura una asistencia de lubricación suficiente para las partes móviles.

4. FILTRACIÓN DE FLUJO COMBINADO DUAL

En un comienzo se disponían de dos filtros, uno de flujo completo que asistía la lubricación del motor y otro de flujo parcial que apoyaba la filtración y disponía hasta de un 10% del aceite filtrado fino al cárter, luego, el diseño cambia a un solo filtro que contiene dos elementos filtrantes. Esta unidad fue llamada filtro de aceite de flujo dual.

Sistema de flujo completo / derivación

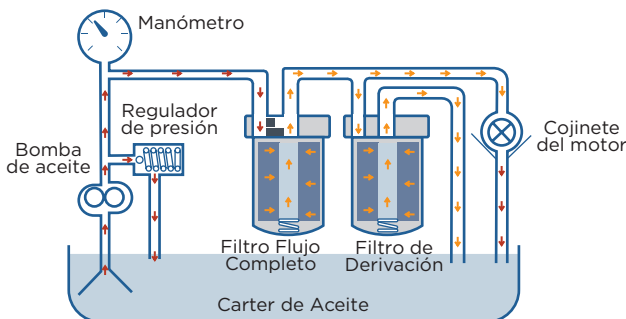

5. FILTRACIÓN DE FLUJO COMBINADO VENTURY

Recientemente, en los motores diésel, se cambia el método de lubricación por el flujo ventury. En este método un filtro con dos elementos filtrantes, uno de filtración media de flujo completo y otro de filtración fina de flujo parcial, combinan los flujos en una sola salida hacia el motor, asegurando que la filtración sea más efectiva en las partes móviles.

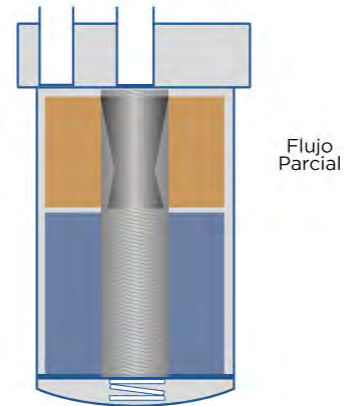

La filtración de flujo Ventury o de alta velocidad ha sido el método de filtración más acertado hasta el momento, diseñado para asistir los requerimientos específicos de los modernos motores electrónicos diésel. Las recomendaciones de los fabricantes de motores en este método de filtración combinada, llegan a 1'600.000 kilómetros como rango umbral antes de una reparación mayor al motor.

VENTAJAS DE LA FILTRACIÓN COMBINADA

1. FILTROS DE FLUJO COMBINADO, Filtro de flujo completo MÁS filtro de flujo parcial

En un sistema de lubricación en el motor diésel con el método de filtración combinada existen dos elementos filtrantes con una función específica en el trabajo de la limpieza del aceite contaminado, producto de la combustión, la admisión de aire y la inyección de combustible.

Cualquiera que sean los filtros que combinen los sistemas de filtración de flujo completo con el sistema de filtración de flujo parcial, ofrece unas ventajas que podemos referenciar bajo pruebas de campo de motores realizadas por la compañía Cummins Filtration, con relación al desgaste de los componentes de casquetería y anillos con cada uno de los sistemas de filtración.

Un elemento de flujo parcial cumple dos funciones básicas, proveer una alta eficiencia de filtración y una alta retención de partículas contaminantes. El diseño de un método de filtración combinada busca disponer de una filtración acertada con un aceite limpio al motor y una protección extra, con un filtro de flujo parcial. Con esto se remueven contaminantes más finos y se mantiene un aceite más limpio que permita darle una mayor durabilidad al motor antes de proceder a una reparación parcial o total a los componentes desgastados.

Una filtración de flujo completo viene proporcionada para asistir la lubricación durante la operación normal del motor y en especial en los arranques en frío. Consecuentemente una filtración de flujo completo con una porosidad definida no puede ser reducida, pues ello implicaría un taponamiento prematuro con una apertura temprana de la válvula de alivio del sistema de lubricación que va en detrimento de la vida del motor.

ACEITE

Está demostrado que la filtración de flujo parcial remueve gran cantidad de material orgánico como hollín, barnices, resinas, carbón, combustible semi quemado, etc. Este trabajo del filtro de flujo parcial muestra una remoción de más del 80% de material orgánico del aceite lo que redundará en reducción del desgaste de los componentes del motor, una protección al filtro de flujo completo, y una reducción de los depósitos en el aceite.

PORCENTAJE DE DESGASTE EN CASQUETES DE BIELA Y BANCADA POR TIPO DE FILTRACIÓN DE ACEITE DIÉSEL

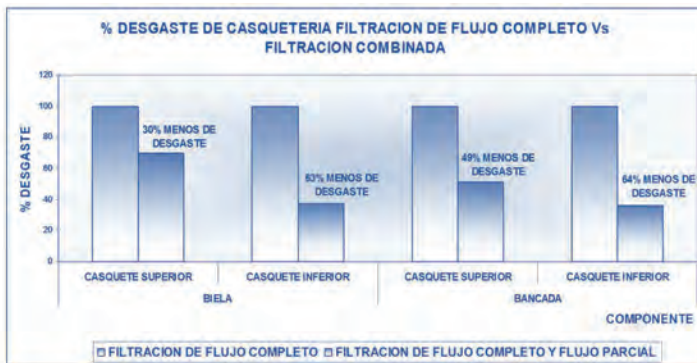

Comparativamente un sistema de lubricación con solo filtro de aceite de flujo completo, en lugar de un filtro dual se traduce en una reducción entre el 30% y el 64% de desgaste, menos el porcentaje de desgaste de la casquetería de biela y bancada del

motor al usar filtros combinados (duales) en lugar de filtros de flujo completo.

En otro estudio, pruebas en motores han comparado el desgaste en los anillos de compresión superior, anillos de compresión medio y anillos de rascador de aceite, al ser operados con filtración de flujo completa y filtración de flujo combinada (filtración de flujo completo más filtración de flujo parcial). Los resultados dispuestos en la imagen siguiente muestran una reducción en el desgaste entre el 7% y el 63% al usar filtros duales (filtros con dos elementos, uno de flujo completo y otro de flujo parcial) en lugar de filtros de solo flujo completo.

PORCENTAJE DE DESGASTE EN ANILLOS POR TIPO DE FILTRACIÓN DE ACEITE DIÉSEL



LOS FILTROS DE ACEITE FLUJO PLENO TIENEN MEJOR DESEMPEÑO

Cada filtro de aceite necesita combinar con eficacia tres características clave: eficiencia en remoción de contaminantes, capacidad de retención de contaminantes y restricción ó resistencia al flujo:

- Mayor eficiencia de captura de contaminantes, desde partículas hasta lodo
- Mayor capacidad de retención de contaminantes
- Restricción mínima al flujo de aceite
- Medios filtrantes semisintéticos que aseguran mayor eficiencia en retención de partículas contaminantes.
- Disminuye la concentración de contaminantes en el aceite del cárter.
- Aumenta la vida útil de los componentes móviles del motor, extendiendo el tiempo previo a la primera reparación.
- Reduce costos de mantenimiento, Los filtros de aceite de flujo completo podrían ser más económicos que los filtros de flujo Dual.

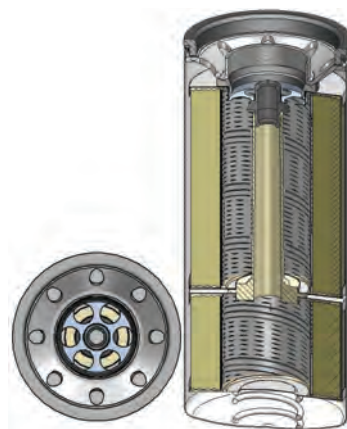

AD3000SP
Flujo dual

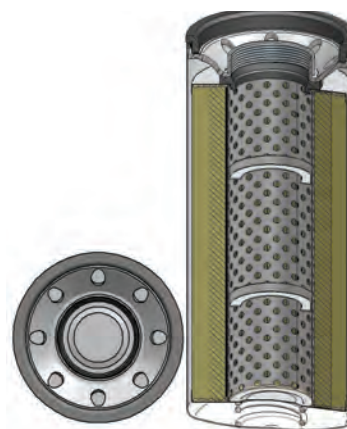

A3000SP
Flujo pleno

CAPACIDAD DE RETENCIÓN DE CONTAMINANTES

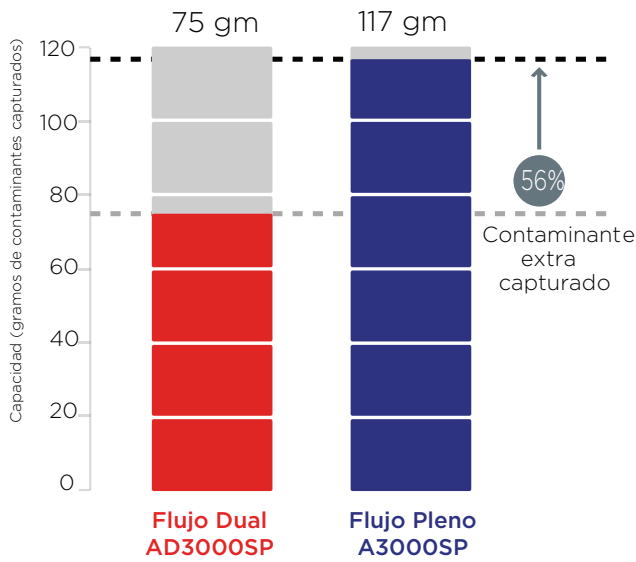

Probados según ISO 4548-12. Caudal a 105 lpm. Terminación a 25 psi/172,3 kPa.

El promedio de los resultados de las pruebas se determinó con seis filtros por número de parte. Los resultados de pruebas individuales pueden variar.

EFICIENCIA EN REMOCIÓN DE CONTAMINANTES

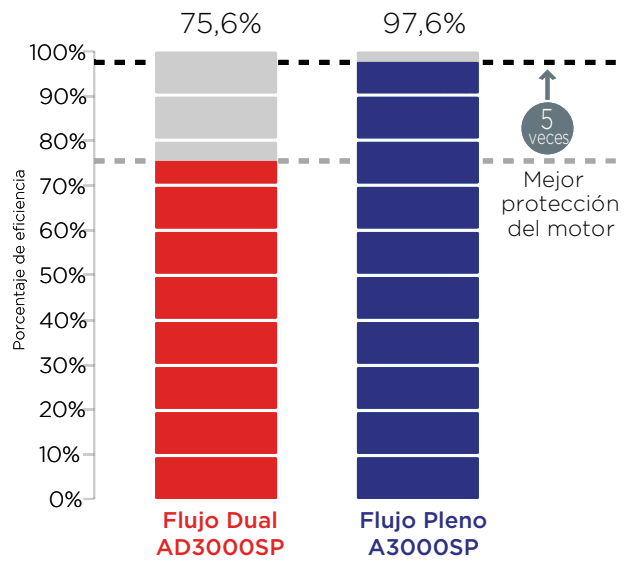

Probados según ISO 4548-12. Caudal a 105 lpm. Promedio de eficiencia ponderado por tiempo a $\geq 15 \mu\text{m}(c)$. Terminación a 25 psi/172,3 kPa.

El promedio de los resultados de las pruebas se determinó con seis filtros por número de parte. Los resultados de pruebas individuales pueden variar.

Mayor eficiencia se traduce en 5 veces menos partículas dañinas que llegan al motor.

Nuestros filtros han protegido motores con éxito en el recorrido de millones de kilómetros.



ACEITE



A091AE

**LDD / LIVIANO DIÉSEL
ACEITE**

FLUJO COMPLETO

D. Exterior	93.7 mm
Altura	165 mm
Rosca	M20x1.5 mm
V. de presión	8 a 11 psi
V. Antidrenaje	SI
Sello central	NO

**APLICACIONES
ASIA / KIA**



A092SP

**LDD / LIVIANO DIÉSEL
ACEITE**

FLUJO COMPLETO

D. Exterior	107,8 mm
Altura	130,6 mm
Rosca	M26x1,5
V. de presión	17 a 19 psi
V. Antidrenaje	SI
Sello central	NO

**APLICACIONES
KIA / FORD / HYUNDAI
MITSUBISHI**



A1

**LD / LIVIANO
ACEITE**

FLUJO COMPLETO

D. Exterior	93.7 mm
Altura	139 mm
Rosca	3/4x16 in
V. de presión	8 a 11 psi
V. Antidrenaje	SI
Sello central	NO

**APLICACIONES
DODGE / CHRYSLER**



A1 SIN TUERCA

**LD / LIVIANO
ACEITE**

FLUJO COMPLETO

D. Exterior	93.7 mm
Altura	139 mm
Rosca	3/4x16 in
V. de presión	8 a 11 psi
V. Antidrenaje	SI
Sello central	NO

**APLICACIONES
DODGE / CHRYSLER**



A1SP

**LD / LIVIANO
ACEITE**

FLUJO COMPLETO

D. Exterior	93.7 mm
Altura	139 mm
Rosca	3/4x16 in
V. de presión	8 a 11 psi
V. Antidrenaje	SI
Sello central	NO

**APLICACIONES
DODGE / CHRYSLER**



A105

**HD / PESADO
ACEITE**

FLUJO COMPLETO

D. Exterior	118.3 mm
Altura	156 mm
Rosca	1-1/2"x12
V. de presión	17 a 19 psi
V. Antidrenaje	NO
Sello central	NO

**APLICACIONES
CHEVROLET / G.M.C. / HINO**



A105SP

**HD / PESADO
ACEITE**

FLUJO COMPLETO

D. Exterior	118.3 mm
Altura	156 mm
Rosca	1-1/2"x12
V. de presión	17 a 19 psi
V. Antidrenaje	NO
Sello central	NO

**APLICACIONES
CHEVROLET / G.M.C. / HINO**



A11

**LD / LIVIANO
ACEITE**

FLUJO COMPLETO

D. Exterior	93.7 mm
Altura	139 mm
Rosca	13/16x16 in
V. de presión	0 psi
V. Antidrenaje	NO
Sello central	NO

**APLICACIONES
CHEVROLET**



A111

**LD / LIVIANO
ACEITE**

FLUJO COMPLETO

D. Exterior	74.2 mm
Altura	98 mm
Rosca	M18x1.5 mm
V. de presión	0 psi
V. Antidrenaje	SI
Sello central	NO

**APLICACIONES
CHEVROLET / DAEWOO**



A111 SIN TUERCA

**LD / LIVIANO
ACEITE**

FLUJO COMPLETO

D. Exterior	74.2 mm
Altura	98 mm
Rosca	M18x1.5 mm
V. de presión	0 psi
V. Antidrenaje	SI
Sello central	NO

**APLICACIONES
CHEVROLET / DAEWOO**



A113

**LD / LIVIANO
ACEITE**

FLUJO COMPLETO

D. Exterior	81.3 mm
Altura	113 mm
Rosca	3/4x16 in
V. de presión	0 psi
V. Antidrenaje	SI
Sello central	NO

**APLICACIONES
NISSAN**



A116CSP

**HD / PESADO
ACEITE**

FLUJO COMPLETO

D. Exterior	118.3 mm
Altura	238 mm
Rosca	1-1/2x12 in
V. de presión	0 psi
V. Antidrenaje	NO
Sello central	NO

**APLICACIONES
CHEVROLET**



A116SP
HD / PESADO
ACEITE
FLUJO COMPLETO

D. Exterior	118.3 mm
Altura	290 mm
Rosca	1-1/2x12 in
V. de presión	0 psi
V. Antidrenaje	NO
Sello central	NO

APLICACIONES
DAEWOO



A12
LDD / LIVIANO DIÉSEL
ACEITE
FLUJO COMPLETO

D. Exterior	93.7 mm
Altura	107 mm
Rosca	13/16x16 in
V. de presión	0 psi
V. Antidrenaje	NO
Sello central	NO

APLICACIONES
GMC



A129SP
HD / PESADO
ACEITE
FLUJO COMPLETO

D. Exterior	107.8 mm
Altura	185 mm
Rosca	1x12 in
V. de presión	8 a 11 psi
V. Antidrenaje	NO
Sello central	NO

APLICACIONES
MERCEDES BENZ



A134
MD / MEDIANO
ACEITE
FLUJO COMPLETO

D. Exterior	107.8 mm
Altura	142.5 mm
Rosca	1x12 in
V. de presión	8 a 11 psi
V. Antidrenaje	NO
Sello central	NO

APLICACIONES
FORD / FOTON



A1402
LD / LIVIANO
ACEITE
FLUJO COMPLETO

D. Exterior	68 mm
Altura	91 mm
Rosca	M20x1.5 mm
V. de presión	8 a 11 psi
V. Antidrenaje	SI
Sello central	NO

APLICACIONES
HONDA/GREAT WALL/JAC
MAZDA/MITSUBISHI/CHEVROLET



A1402PLUS
LD / LIVIANO
ACEITE
FLUJO COMPLETO

D. Exterior	68 mm
Altura	91 mm
Rosca	M20x1.5 mm
V. de presión	8 a 11 psi
V. Antidrenaje	SI
Sello central	NO

APLICACIONES
HONDA/GREAT WALL/JAC
MAZDA/MITSUBISHI/CHEVROLET



A1403SP
HD / PESADO
ACEITE
FLUJO DUAL

D. Exterior	118.3 mm
Altura	220 mm
Rosca	M36x1.5 mm
V. de presión	0 psi
V. Antidrenaje	NO
Sello central	NO

APLICACIONES
MITSUBISHI / NISSAN



A1406
LD / LIVIANO
ACEITE
FLUJO COMPLETO

D. Exterior	68 mm
Altura	91 mm
Rosca	3/4x16 in
V. de presión	8 a 11 psi
V. Antidrenaje	SI
Sello central	NO

APLICACIONES
CHEVROLET / NISSAN



A1406PLUS
LD / LIVIANO
ACEITE
FLUJO COMPLETO

D. Exterior	68 mm
Altura	91 mm
Rosca	3/4x16 in
V. de presión	8 a 11 psi
V. Antidrenaje	SI
Sello central	NO

APLICACIONES
CHEVROLET / DAIHATSU / NISSAN
SUZUKI / TOYOTA



A1428
MD / MEDIANO
ACEITE
FLUJO COMPLETO

D. Exterior	93.7 mm
Altura	140 mm
Rosca	13/16x16 in
V. de presión	0
V. Antidrenaje	SI
Sello central	NO

APLICACIONES
CHEVROLET



A142SP
MD / MEDIANO
ACEITE
FLUJO DUAL

D. Exterior	107.8 mm
Altura	131 mm
Rosca	1x12 in
V. de presión	0 psi
V. Antidrenaje	SI
Sello central	NO

APLICACIONES
CHEVROLET



A14302PLUS
LDD / LIVIANO DIÉSEL
ACEITE
FLUJO COMPLETO

D. Exterior	76.4 mm
Altura	97 mm
Rosca	3/4x16 in
V. de presión	8 a 11 psi
V. Antidrenaje	SI
Sello central	NO

APLICACIONES
FORD / MAZDA / TOYOTA / CHERY
VOLKSWAGEN



A1432
LD / LIVIANO
ACEITE
FLUJO COMPLETO

D. Exterior	74.2 mm
Altura	104 mm
Rosca	13/16x16 in
V. de presión	0 psi
V. Antidrenaje	SI
Sello central	NO

APLICACIONES
CHEVROLET



A14476
LD / LIVIANO
ACEITE
FLUJO COMPLETO

D. Exterior	68 mm
Altura	72 mm
Rosca	3/4x16 in
V. de presión	8 a 11 psi
V. Antidrenaje	SI
Sello central	NO

APLICACIONES
CHEVROLET / GEELY / TOYOTA
GREAT WALL



A14476PLUS
LD / LIVIANO
ACEITE
FLUJO COMPLETO

D. Exterior	68 mm
Altura	72 mm
Rosca	3/4x16 in
V. de presión	8 a 11 psi
V. Antidrenaje	SI
Sello central	NO

APLICACIONES
CHANA / CHERY / CHEVROLET DAEWOO
DAIHATSU / DFSK / HAFEI / SUZUKI / TOYOTA



A14478PLUS
LD / LIVIANO
ACEITE
FLUJO COMPLETO

D. Exterior	68 mm
Altura	58 mm
Rosca	3/4x16 in
V. de presión	8 a 11 psi
V. Antidrenaje	SI
Sello central	NO

APLICACIONES
GEELY / SUZUKI



A14616
LD / LIVIANO
ACEITE
FLUJO COMPLETO

D. Exterior	68 mm
Altura	72 mm
Rosca	M18x1.5 mm
V. de presión	8 a 11 psi
V. Antidrenaje	SI
Sello central	NO

APLICACIONES
FOTON



A14616PLUS
LD / LIVIANO
ACEITE
FLUJO COMPLETO

D. Exterior	68 mm
Altura	72 mm
Rosca	M18x1.5 mm
V. de presión	8 a 11 psi
V. Antidrenaje	SI
Sello central	NO

APLICACIONES
CHEVROLET



A1480
MD / MEDIANO
ACEITE
FLUJO COMPLETO

D. Exterior	107.8 mm
Altura	143 mm
Rosca	M26x1.5 mm
V. de presión	8 a 11 psi
V. Antidrenaje	NO
Sello central	NO

APLICACIONES
HINO / MITSUBISHI / HYUNDAI



A15403
LDD / LIVIANO DIÉSEL
ACEITE
FLUJO COMPLETO

D. Exterior	76 mm
Altura	139 mm
Rosca	M27x1.5
V. de presión	0 psi
V. Antidrenaje	NO
Sello central	NO

APLICACIONES
VOLKSWAGEN



A160
LD / LIVIANO
ACEITE
FLUJO COMPLETO

D. Exterior	74.2 mm
Altura	98 mm
Rosca	M22x1.5 mm
V. de presión	8 a 11 psi
V. Antidrenaje	SI
Sello central	NO

APLICACIONES
CHEVROLET / DODGE / FORD
JEEP



A160PLUS
LD / LIVIANO
ACEITE
FLUJO COMPLETO

D. Exterior	74.2 mm
Altura	98 mm
Rosca	M22x1.5 mm
V. de presión	8 a 11 psi
V. Antidrenaje	SI
Sello central	NO

APLICACIONES
CHEVROLET / DODGE / FORD
JEEP



A16242SP
OTROS
ACEITE
FLUJO COMPLETO

D. Exterior	93.7 mm
Altura	83.5 mm
Rosca	1x12
V. de presión	30 psi
V. Antidrenaje	SI
Sello central	NO

APLICACIONES
CASE / KOMATSU



A178PLUS
LD / LIVIANO
ACEITE
FLUJO COMPLETO

D. Exterior	74.2 mm
Altura	125 mm
Rosca	3/4x16 in
V. de presión	30 psi
V. Antidrenaje	SI
Sello central	NO

APLICACIONES
HYUNDAI / KIA / BMW FAW /
FORD / VOLKSWAGEN



A178SP
LD / LIVIANO
ACEITE
FLUJO COMPLETO

Doble válvula de alivio

D. Exterior	74.2 mm
Altura	125 mm
Rosca	3/4x16 in
V. de presión	30 psi
V. Antidrenaje	SI
Sello central	NO

APLICACIONES
VOLKSWAGEN



A18
LD / LIVIANO
ACEITE
FLUJO COMPLETO

D. Exterior	74.2 mm
Altura	84 mm
Rosca	3/4x16 in
V. de presión	8 a 11 psi
V. Antidrenaje	SI
Sello central	NO

APLICACIONES
CHEVROLET / DAEWOO / TOYOTA



A18 SIN TUERCA
LD / LIVIANO
ACEITE
FLUJO COMPLETO

D. Exterior	74.2 mm
Altura	84 mm
Rosca	3/4x16 in
V. de presión	8 a 11 psi
V. Antidrenaje	SI
Sello central	NO

APLICACIONES
CHEVROLET / DAEWOO / TOYOTA



A18PLUS
LD / LIVIANO
ACEITE
FLUJO COMPLETO

D. Exterior	74.2 mm
Altura	84 mm
Rosca	3/4x16 in
V. de presión	8 a 11 psi
V. Antidrenaje	SI
Sello central	NO

APLICACIONES
CHEVROLET



A1DQ0001012011
OTROS
ACEITE
FLUJO COMPLETO

D. Exterior	93.7 mm
Altura	207 mm
Rosca	1x12 in
V. de presión	8 a 11 psi
V. Antidrenaje	NO
Sello central	NO

APLICACIONES
YUCHAI



A20
LD / LIVIANO
ACEITE
FLUJO COMPLETO

D. Exterior	93.7 mm
Altura	108 mm
Rosca	3/4x16 in
V. de presión	8 a 11 psi
V. Antidrenaje	SI
Sello central	NO

APLICACIONES
NISSAN / FIAT / JEEP / RENAULT
TOYOTA / SCANIA



A20PLUS
LD / LIVIANO
ACEITE
FLUJO COMPLETO

D. Exterior	93.7 mm
Altura	108 mm
Rosca	3/4x16 in
V. de presión	8 a 11 psi
V. Antidrenaje	SI
Sello central	NO

APLICACIONES
NISSAN / FIAT / JEEP / RENAULT
TOYOTA / SCANIA



A205SP
HD / PESADO
ACEITE
FLUJO COMPLETO

D. Exterior	118.3 mm
Altura	205 mm
Rosca	1-1/2x12 in
V. de presión	17-19 psi
V. Antidrenaje	NO
Sello central	NO

APLICACIONES
HINO / CHEVROLET



A2210SP
MD / MEDIANO
ACEITE
FLUJO DUAL

D. Exterior	107.8 mm
Altura	149 mm
Rosca	1x16 in
V. de presión	0 psi
V. Antidrenaje	NO
Sello central	NO

APLICACIONES
HINO



A223
LD / LIVIANO
ACEITE
FLUJO COMPLETO

D. Exterior	74.2 mm
Altura	98 mm
Rosca	3/4x16 in
V. de presión	8 a 11 psi
V. Antidrenaje	SI
Sello central	NO

APLICACIONES
CHERY / CHEVROLET / DAIHATSU
JEEP / SKODA / SUZUKI



A223 SIN TUERCA
LD / LIVIANO
ACEITE
FLUJO COMPLETO

Sin tuerca

D. Exterior	74.2 mm
Altura	98 mm
Rosca	3/4x16 in
V. de presión	8 a 11 psi
V. Antidrenaje	SI
Sello central	NO

APLICACIONES
FORD / JEEP / MAZDA / SKODA
TOYOTA / VOLVO / VOLKSWAGEN



A22SP
HD / PESADO
ACEITE
FLUJO COMPLETO

D. Exterior	107.8 mm
Altura	185 mm
Rosca	3/4x16 in
V. de presión	17 a 19 psi
V. Antidrenaje	SI
Sello central	NO

APLICACIONES
TOYOTA



A232SP

**MD / MEDIANO
ACEITE
FLUJO DUAL**

D. Exterior	107.8 mm
Altura	145 mm
Rosca	3/4x16 in
V. de presión	30 psi
V. Antidrenaje	SI
Sello central	NO

**APLICACIONES
IVECO**



A26SP

**OTRO
ACEITE
FLUJO COMPLETO**

D. Exterior	93.7 mm
Altura	139 mm
Rosca	13/16x16 in
V. de presión	8 a 11 psi
V. Antidrenaje	SI
Sello central	NO

**APLICACIONES
JEEP / JOHN DEERE**



A2700SP

**MD / MEDIANO
ACEITE
FLUJO COMPLETO**

D. Exterior	118.3 mm
Altura	125 mm
Rosca	1-1/2x12 in
V. de presión	17 a 19 psi
V. Antidrenaje	NO
Sello central	NO

**APLICACIONES
CHEVROLET**



A2849A

**MD / MEDIANO
ACEITE
FLUJO COMPLETO**

D. Exterior	74.8 mm
Altura	125 mm
Rosca	M20x1.5
V. de presión	8 a 11 psi
V. Antidrenaje	SI
Sello central	NO

**APLICACIONES
FORD / PEUGEOT**



A2863B

**LDD / LIVIANO DIÉSEL
ACEITE
FLUJO COMPLETO**

D. Exterior	93.7 mm
Altura	98 mm
Rosca	M20x1.5 mm
V. de presión	8 a 11 psi
V. Antidrenaje	SI
Sello central	NO

**APLICACIONES
CHEVROLET**



A2863SP

**LD / LIVIANO DIÉSEL
ACEITE
FLUJO COMPLETO**

D. Exterior	93.7 mm
Altura	111 mm
Rosca	M20x1.5 mm
V. de presión	8 a 11 psi
V. Antidrenaje	SI
Sello central	NO

**APLICACIONES
FOTON / JAC / CHEVROLET / CHERY
GREAT WALL / JIMBEI / ZHAN-QI**



A28SP

**LDD / LIVIANO DIÉSEL
ACEITE
FLUJO COMPLETO**

D. Exterior	93.7 mm
Altura	120 mm
Rosca	M26x1.5 mm
V. de presión	17 a 19 psi
V. Antidrenaje	SI
Sello central	NO

**APLICACIONES
HYUNDAI / KIA**



A291

**MD / MEDIANO
ACEITE
FLUJO PARCIAL**

D. Exterior	93.7 mm
Altura	97 mm
Rosca	M18x1.5 mm
V. de presión	0 psi
V. Antidrenaje	NO
Sello central	SI

**APLICACIONES
HYUNDAI / MITSUBISHI**



A3000SP

**HD / PESADO
ACEITE
FLUJO COMPLETO**

D. Exterior	118.3 mm
Altura	292 mm
Rosca	2-1/4x12 in
V. de presión	0 psi
V. Antidrenaje	NO
Sello central	NO

**APLICACIONES
KENWORTH / NEW HOLLAND
VOLKSWAGEN**



A309SP

**HD / PESADO
ACEITE
FLUJO COMPLETO**

D. Exterior	107.8 mm
Altura	185 mm
Rosca	1x12 in
V. de presión	0 psi
V. Antidrenaje	NO
Sello central	NO

**APLICACIONES
INTERNATIONAL
MERCEDES BENZ**



A323

**LD / LIVIANO
ACEITE
FLUJO COMPLETO**

D. Exterior	81.3 mm
Altura	79 mm
Rosca	M20x1.5 mm
V. de presión	8 a 11 psi
V. Antidrenaje	SI
Sello central	NO

**APLICACIONES
CHEVROLET / HONDA / MAZDA
MITSUBISHI**



A323 SIN TUERCA

**LD / LIVIANO
ACEITE
FLUJO COMPLETO**

D. Exterior	81.3 mm
Altura	79 mm
Rosca	M20x1.5 mm
V. de presión	8 a 11 psi
V. Antidrenaje	SI
Sello central	NO

**APLICACIONES
CHEVROLET / HONDA / MAZDA
MITSUBISHI**



A323PLUS

**LD / LIVIANO
ACEITE
FLUJO COMPLETO**

D. Exterior	81.3 mm
Altura	79 mm
Rosca	M20x1.5 mm
V. de presión	8 a 11 psi
V. Antidrenaje	SI
Sello central	NO

APLICACIONES
FORD / KIA



A329

**LD / LIVIANO
ACEITE
FLUJO COMPLETO**

D. Exterior	81.3 mm
Altura	79 mm
Rosca	M22x1.5 mm
V. de presión	8 a 11 psi
V. Antidrenaje	SI
Sello central	NO

APLICACIONES
IVECO / GREAT WALL / DODGE
FORD / HONDA / JEEP



A33

**LD / LIVIANO
ACEITE
FLUJO COMPLETO**

D. Exterior	93.7 mm
Altura	108 mm
Rosca	13/16x16 in
V. de presión	0 psi
V. Antidrenaje	SI
Sello central	NO

APLICACIONES
BUICK



A339SP

**HD / PESADO
ACEITE
FLUJO COMPLETO**

D. Exterior	93.7 mm
Altura	165 mm
Rosca	1x16 in
V. de presión	0 psi
V. Antidrenaje	NO
Sello central	NO

APLICACIONES
DODGE / FORD / KENWORTH
YUTONG / VOLKSWAGEN



A343

**OTROS
ACEITE
FLUJO COMPLETO**

D. Exterior	136.5 mm
Altura	158 mm
Rosca	1-1/8x16 in
V. de presión	17 a 19 psi
V. Antidrenaje	SI
Sello central	NO

APLICACIONES
FORD



A349

**OTROS
ACEITE
FLUJO COMPLETO**

D. Exterior	107.8 mm
Altura	235 mm
Rosca	1x12 in
V. de presión	17 a 19 psi
V. Antidrenaje	SI
Sello central	NO

APLICACIONES
FORD / FIAT



A350

**LDD / LIVIANO DIESEL
ACEITE
FLUJO COMPLETO**

D. Exterior	107.8 mm
Altura	131 mm
Rosca	M20x1.5 mm
V. de presión	17 a 19 psi
V. Antidrenaje	SI
Sello central	NO

APLICACIONES
KIA



A354

**HD / PESADO
ACEITE
FLUJO COMPLETO**

D. Exterior	93.7 mm
Altura	136 mm
Rosca	1-1/8x16 in
V. de presión	8 a 11 psi
V. Antidrenaje	NO
Sello central	NO

APLICACIONES
FORD / FOTON / NEW HOLLAND



A3603

**MD / MEDIANO
ACEITE
FLUJO COMPLETO**

D. Exterior	74.2 mm
Altura	60 mm
Rosca	M20x1.5 mm
V. de presión	8 a 11 psi
V. Antidrenaje	SI
Sello central	NO

APLICACIONES
RENAULT / ZOTIE



A3603PLUS

**LD / LIVIANO
ACEITE
FLUJO COMPLETO**

D. Exterior	76.4 mm
Altura	60 mm
Rosca	M20x1.5 mm
V. de presión	8 a 11 psi
V. Antidrenaje	SI
Sello central	NO

APLICACIONES
RENAULT / SSANGYONG



A3612ASP

**OTROS
ACEITE
FLUJO COMPLETO**

D. Exterior	107.8 mm
Altura	263 mm
Rosca	1-1/2x12 in
V. de presión	0 psi
V. Antidrenaje	NO
Sello central	NO

APLICACIONES
ALLIS CHALMERS



A372

**LD / LIVIANO
ACEITE
FLUJO COMPLETO**

D. Exterior	81.3 mm
Altura	137 mm
Rosca	3/4x16 in
V. de presión	8 a 11 psi
V. Antidrenaje	SI
Sello central	NO

APLICACIONES
FORD / DAIHATSU



A3757ASP

**MD / MEDIANO
ACEITE**

FLUJO COMPLETO

D. Exterior	107.8 mm
Altura	204 mm
Rosca	1-1/2x12 in
V. de presión	0 psi
V. Antidrenaje	NO
Sello central	NO

**APLICACIONES
CHEVROLET**



A3786SP

**MD / MEDIANO
ACEITE**

FLUJO COMPLETO

D. Exterior	107.8 mm
Altura	204 mm
Rosca	1-1/2x16
V. de presión	0 psi
V. Antidrenaje	NO
Sello central	NO

**APLICACIONES
HINO / INTERNATIONAL**



A40053SP

**HD / PESADO
ACEITE**

FLUJO COMPLETO

D. Exterior	118.3 mm
Altura	253 mm
Rosca	1-5/8x12 in
V. de presión	30 psi
V. Antidrenaje	NO
Sello central	NO

**APLICACIONES
INTERNATIONAL**



A4011

**LD / LIVIANO
ACEITE**

FLUJO COMPLETO

D. Exterior	74.2 mm
Altura	125 mm
Rosca	M18x1.5 mm
V. de presión	0 psi
V. Antidrenaje	SI
Sello central	NO

**APLICACIONES
CHEVROLET**



A4041

**LD / LIVIANO
ACEITE**

FLUJO COMPLETO

D. Exterior	81.3 mm
Altura	79 mm
Rosca	3/4x16 in
V. de presión	8 a 11 psi
V. Antidrenaje	SI
Sello central	NO

**APLICACIONES
SUZUKI**



A4044

**LD / LIVIANO
ACEITE**

FLUJO COMPLETO

D. Exterior	93.7 mm
Altura	108 mm
Rosca	M20x1.5 mm
V. de presión	8 a 11 psi
V. Antidrenaje	SI
Sello central	NO

**APLICACIONES
FOTON / GOLDEN DRAGON
CHEVROLET**



A4046

**LDD / LIVIANO DIÉSEL
ACEITE**

FLUJO COMPLETO

D. Exterior	93.7 mm
Altura	139 mm
Rosca	M20x1.5 mm
V. de presión	8 a 11 psi
V. Antidrenaje	SI
Sello central	NO

**APLICACIONES
DAIHATSU / TOYOTA**



A4048SP

**MD / MEDIANO
ACEITE**

FLUJO COMPLETO

D. Exterior	107.8 mm
Altura	143 mm
Rosca	1x12 in
V. de presión	8 a 11 psi
V. Antidrenaje	NO
Sello central	NO

**APLICACIONES
HINO / MAZDA**



A4049SP

**MD / MEDIANO
ACEITE**

FLUJO PARCIAL

D. Exterior	93.7 mm
Altura	129 mm
Rosca	M20x1.5 mm
V. de presión	0 psi
V. Antidrenaje	NO
Sello central	NO

**APLICACIONES
MAZDA**



A4050

**LDD / LIVIANO DIÉSEL
ACEITE**

FLUJO COMPLETO

D. Exterior	81.3 mm
Altura	112 mm
Rosca	3/4x16 in
V. de presión	8 a 11 psi
V. Antidrenaje	SI
Sello central	NO

**APLICACIONES
CHEVROLET**



A4050 SIN TUERCA

**LDD / LIVIANO DIÉSEL
ACEITE**

FLUJO COMPLETO

D. Exterior	81.3 mm
Altura	112 mm
Rosca	3/4x16 in
V. de presión	8 a 11 psi
V. Antidrenaje	SI
Sello central	NO

**APLICACIONES
CHEVROLET**



A4050PLUS

**LDD / LIVIANO DIÉSEL
ACEITE**

FLUJO COMPLETO

D. Exterior	81.3 mm
Altura	112 mm
Rosca	3/4x16 in
V. de presión	8 a 11 psi
V. Antidrenaje	SI
Sello central	NO

**APLICACIONES
CHEVROLET**



A4051SP
MD / MEDIANO
ACEITE
FLUJO COMPLETO

D. Exterior	81.3 mm
Altura	103 mm
Rosca	M22x1.5 mm
V. de presión	8 a 11 psi
V. Antidrenaje	SI
Sello central	NO

APLICACIONES
CHEVROLET



A4052SP
MD / MEDIANO
ACEITE
FLUJO PARCIAL

D. Exterior	107.8 mm
Altura	82 mm
Rosca	M20x1.5 mm
V. de presión	0 psi
V. Antidrenaje	NO
Sello central	NO

APLICACIONES
CHEVROLET / KIA



A4056
LD / LIVIANO
ACEITE
FLUJO COMPLETO

D. Exterior	74.2 mm
Altura	98 mm
Rosca	M20x1.5 mm
V. de presión	8 a 11 psi
V. Antidrenaje	NO
Sello central	NO

APLICACIONES
CITROEN / FIAT / KIA / SUBARU



A408SP
HD / PESADO
ACEITE
FLUJO COMPLETO

D. Exterior	136.5 mm
Altura	289 mm
Rosca	M36x1.5 mm
V. de presión	30 psi
V. Antidrenaje	NO
Sello central	NO

APLICACIONES
INTERNATIONAL / DINA / NISSAN



A4271SP
MD / MEDIANO
ACEITE
FLUJO COMPLETO

D. Exterior	93.7 mm
Altura	130 mm
Rosca	M26x1.5 mm
V. de presión	8 a 11 psi
V. Antidrenaje	SI
Sello central	NO

APLICACIONES
CHEVROLET



A427SP
MD / MEDIANO
ACEITE
FLUJO COMPLETO

D. Exterior	93.7 mm
Altura	129 mm
Rosca	1x16 in
V. de presión	0 psi
V. Antidrenaje	NO
Sello central	NO

APLICACIONES
DONG FENG / FORD / JAC
DODGE



A4317SP
HD / PESADO
ACEITE
FLUJO DUAL

D. Exterior	107.8 mm
Altura	203 mm
Rosca	M38x1.5 mm
V. de presión	17 a 19 psi
V. Antidrenaje	NO
Sello central	NO

APLICACIONES
HYUNDAI



A43S
LD / LIVIANO
ACEITE
FLUJO COMPLETO

D. Exterior	74.2 mm
Altura	84 mm
Rosca	M18x1.5 mm
V. de presión	0 psi
V. Antidrenaje	SI
Sello central	NO

APLICACIONES
CHEVROLET



A447
MD / MEDIANO
ACEITE
FLUJO COMPLETO

D. Exterior	107.8 mm
Altura	117 mm
Rosca	1x12 in
V. de presión	17 a 19 psi
V. Antidrenaje	SI
Sello central	NO

APLICACIONES
JAC / JBC



A4731SP
MD / MEDIANO
ACEITE
FLUJO COMPLETO

D. Exterior	107.8 mm
Altura	131 mm
Rosca	M20x1.5 mm
V. de presión	17 a 19 psi
V. Antidrenaje	SI
Sello central	NO

APLICACIONES
HYUNDAI



A4863
MD / MEDIANO
ACEITE
FLUJO COMPLETO

D. Exterior	93.7 mm
Altura	178 mm
Rosca	1-1/8x16 in
V. de presión	8 a 11 psi
V. Antidrenaje	SI
Sello central	NO

APLICACIONES
INTERNATIONAL / NEW HOLLAND



A48SP
HD / PESADO
ACEITE
FLUJO COMPLETO

D. Exterior	93.7 mm
Altura	165 mm
Rosca	1x12 in
V. de presión	8 a 11 psi
V. Antidrenaje	NO
Sello central	NO

APLICACIONES
FOTON / JIMBEI / DINA / NISSAN
INTERNATIONAL / DONG FENG



A494E

**MD / MEDIANO
ACEITE**

FLUJO PARCIAL

D. Exterior	107.8 mm
Altura	82 mm
Rosca	5/8x18 in
V. de presión	0 psi
V. Antidrenaje	NO
Sello central	NO

**APLICACIONES
CHEVROLET**



A495SP

**HD / PESADO
ACEITE**

FLUJO COMPLETO

D. Exterior	118.3 mm
Altura	253 mm
Rosca	1-5/8x12 in
V. de presión	0 psi
V. Antidrenaje	NO
Sello central	NO

**APLICACIONES
FREIGHTLINER**



A50

**OTROS
ACEITE**

FLUJO PARCIAL

D. Exterior	93.7 mm
Altura	139 mm
Rosca	5/8x18 in
V. de presión	0 psi
V. Antidrenaje	NO
Sello central	NO

**APLICACIONES
CATERPILLAR**



A52

**LD / LIVIANO
ACEITE**

FLUJO COMPLETO

D. Exterior	81.3 mm
Altura	89 mm
Rosca	M20x1.5 mm
V. de presión	8 a 11 psi
V. Antidrenaje	SI
Sello central	NO

**APLICACIONES
GREAT WALL / HYUNDAI / MAZDA KIA
/ MITSUBISHI / SUBARU**



A52 SIN TUERCA

**LD / LIVIANO
ACEITE**

FLUJO COMPLETO

D. Exterior	81.3 mm
Altura	89 mm
Rosca	M20x1.5 mm
V. de presión	8 a 11 psi
V. Antidrenaje	SI
Sello central	NO

**APLICACIONES
GREAT WALL / HYUNDAI / MAZDA KIA
/ MITSUBISHI / SUBARU**



A52041SP

**MD / MEDIANO
ACEITE**

FLUJO COMPLETO

D. Exterior	76.4 mm
Altura	107 mm
Rosca	M22x1.5 mm
V. de presión	8 a 11 psi
V. Antidrenaje	SI
Sello central	NO

**APLICACIONES
JAC**



A53PLUS

**LD / LIVIANO
ACEITE**

FLUJO COMPLETO

D. Exterior	81.3 mm
Altura	89 mm
Rosca	M20x1.5 mm
V. de presión	8 a 11 psi
V. Antidrenaje	SI
Sello central	NO

**APLICACIONES
HYUNDAI**



A54SP

**MD / MEDIANO
ACEITE**

FLUJO COMPLETO

D. Exterior	93.7 mm
Altura	129 mm
Rosca	1x12 in
V. de presión	17 a 19 psi
V. Antidrenaje	NO
Sello central	NO

**APLICACIONES
DONG FENG / JAC / FORD
GOLDEN DRAGON**



A58

**LD / LIVIANO
ACEITE**

FLUJO COMPLETO

D. Exterior	68 mm
Altura	67 mm
Rosca	M20x1.5 mm
V. de presión	8 a 11 psi
V. Antidrenaje	SI
Sello central	NO

**APLICACIONES
HYUNDAI / KIA / MAZDA**



A58PLUS

**LD / LIVIANO
ACEITE**

FLUJO COMPLETO

D. Exterior	68 mm
Altura	67 mm
Rosca	M20x1.5 mm
V. de presión	8 a 11 psi
V. Antidrenaje	SI
Sello central	NO

**APLICACIONES
BRILLANCE/CHANGAN/MAZDA/HYUNDAI GREAT
WALL/KIA/NISSAN/RENAULT/SUBARU**



A58T

**LD / LIVIANO
ACEITE**

FLUJO COMPLETO

D. Exterior	68 mm
Altura	67 mm
Rosca	M20x1.5 mm
V. de presión	8 a 11 psi
V. Antidrenaje	SI
Sello central	NO

**APLICACIONES
HYUNDAI / KIA / MAZDA**



A67SP

**HD / PESADO
ACEITE**

FLUJO COMPLETO

D. Exterior	107.8 mm
Altura	249 mm
Rosca	1-1/8x16 in
V. de presión	0 psi
V. Antidrenaje	NO
Sello central	NO

**APLICACIONES
NISSAN/CHEVROLET/RENAULT/SCANIA
FREIGHTLINER/KENWORTH/MACK/VOLVO**



A69SP

**HD / PESADO
ACEITE
FLUJO COMPLETO**

D. Exterior	136.5 mm
Altura	289 mm
Rosca	1-1/2x16 in
V. de presión	0 psi
V. Antidrenaje	NO
Sello central	NO

APLICACIONES
FREIGHTLINER / INTERNATIONAL
KENWORTH / MACK



A7018

**MD / MEDIANO
ACEITE
FLUJO PARCIAL**

D. Exterior	107.8 mm
Altura	143 mm
Rosca	3/4x16 in
V. de presión	0 psi
V. Antidrenaje	NO
Sello central	NO

APLICACIONES
NISSAN



A7028SP

**MD / MEDIANO
ACEITE
FLUJO COMPLETO**

D. Exterior	107.8 mm
Altura	130 mm
Rosca	M26x1.5 mm
V. de presión	17 a 19 psi
V. Antidrenaje	NO
Sello central	NO

APLICACIONES
MITSUBISHI



A7029SP

**MD / MEDIANO
ACEITE
FLUJO COMPLETO**

D. Exterior	102 mm
Altura	130 mm
Rosca	M24x1.5 mm
V. de presión	8 a 11 psi
V. Antidrenaje	SI
Sello central	NO

APLICACIONES
DAIHATSU / TOYOTA



A7041SP

**MD / MEDIANO
ACEITE
FLUJO COMPLETO**

D. Exterior	118,3 mm
Altura	155 mm
Rosca	1-1/2x12
V. de presión	17 a 19 psi
V. Antidrenaje	NO
Sello central	NO

APLICACIONES
CHEVROLET



A7095

**OTROS
ACEITE
FLUJO DUAL**

D. Exterior	93.7 mm
Altura	178 mm
Rosca	M26x1.5 mm
V. de presión	0 psi
V. Antidrenaje	SI
Sello central	NO

APLICACIONES
THERMOKING



A7105SP

**MD / MEDIANO
ACEITE
FLUJO COMPLETO**

D. Exterior	118.3 mm
Altura	206 mm
Rosca	1-1/2x16 in
V. de presión	17 a 19 psi
V. Antidrenaje	NO
Sello central	NO

APLICACIONES
HINO / NISSAN



A7121SP

**MD / MEDIANO
ACEITE
FLUJO DUAL**

D. Exterior	107.8 mm
Altura	187 mm
Rosca	M26x1.5 mm
V. de presión	8 a 11 psi
V. Antidrenaje	NO
Sello central	NO

APLICACIONES
MITSUBISHI / KOBELCO



A7125

**OTROS
ACEITE
FLUJO COMPLETO**

D. Exterior	93,7 mm
Altura	146 mm
Rosca	1-1/2"x16
V. de presión	17 a 19 psi
V. Antidrenaje	NO
Sello central	NO

APLICACIONES
JOHN DEERE



A7133

**OTROS
ACEITE
FLUJO COMPLETO**

D. Exterior	107,8 mm
Altura	150 mm
Rosca	M24x1.5 mm
V. de presión	17 a 19 psi
V. Antidrenaje	SI
Sello central	NO

APLICACIONES
CHALLENGER



A7144SP

**MD / MEDIANO
ACEITE
FLUJO COMPLETO**

D. Exterior	107,8 mm
Altura	142,5 mm
Rosca	1x12
V. de presión	12-16 psi
V. Antidrenaje	SI
Sello central	NO

APLICACIONES
CHRYSLER / CATERPILLAR
HINO / HITACHI



A7158SP

**OTROS
ACEITE
FLUJO DUAL**

D. Exterior	107.8 mm
Altura	222 mm
Rosca	M32x1.5 mm
V. de presión	8 a 11 psi
V. Antidrenaje	NO
Sello central	NO

APLICACIONES
CATERPILLAR



A7177SP

**HD / PESADO
ACEITE
FLUJO COMPLETO**

D. Exterior	93.7 mm
Altura	174 mm
Rosca	1-1/8x16 in
V. de presión	0 psi
V. Antidrenaje	NO
Sello central	NO

APLICACIONES
BLUE BIRD / CASE / FORD
FREIGHTLINER / KENWORTH



A7223SP

**MD / MEDIANO
ACEITE
FLUJO COMPLETO**

D. Exterior	107.6 mm
Altura	166 mm
Rosca	1-1/8x16
V. de presión	30 psi
V. Antidrenaje	NO
Sello central	NO

APLICACIONES
JMC



A73

**LD / LIVIANO
ACEITE
FLUJO COMPLETO**

D. Exterior	81.3 mm
Altura	112 mm
Rosca	M20x1.5 mm
V. de presión	8 a 11 psi
V. Antidrenaje	SI
Sello central	NO

APLICACIONES
FORD/KIA/CHERY/SUBARU
CHEVROLET/KIA/MAZDA



A73 SIN TUERCA

**LD / LIVIANO
ACEITE
FLUJO COMPLETO**

Sin tuerca

D. Exterior	81.3 mm
Altura	112 mm
Rosca	M20x1.5 mm
V. de presión	8 a 11 psi
V. Antidrenaje	SI
Sello central	NO

APLICACIONES
FORD/KIA/CHERY/SUBARU
CHEVROLET/KIA/MAZDA



A73PLUS

**LD / LIVIANO
ACEITE
FLUJO COMPLETO**

D. Exterior	81.3 mm
Altura	112 mm
Rosca	M20x1.5 mm
V. de presión	8 a 11 psi
V. Antidrenaje	SI
Sello central	NO

APLICACIONES
FORD/KIA/CHERY/SUBARU
CHEVROLET/KIA/MAZDA



A7503SP

**HD / PESADO
ACEITE
FLUJO COMPLETO**

D. Exterior	118.3 mm
Altura	286 mm
Rosca	1-3/4x12 in
V. de presión	30 psi
V. Antidrenaje	NO
Sello central	NO

APLICACIONES
INTERNATIONAL



A7506SP

**HD / PESADO
ACEITE
FLUJO COMPLETO**

D. Exterior	107.6 mm
Altura	223 mm
Rosca	1x16 in
V. de presión	17 a 19 psi
V. Antidrenaje	NO
Sello central	NO

APLICACIONES
INTERNATIONAL



A7685SP

**HD / PESADO
ACEITE
FLUJO PARCIAL**

D. Exterior	107.8 mm
Altura	257 mm
Rosca	1-3/8x16 in
V. de presión	0 psi
V. Antidrenaje	NO
Sello central	NO

APLICACIONES
MACK / RENAULT / VOLVO



A777CSP

**HD / PESADO
ACEITE
FLUJO PARCIAL**

D. Exterior	118.3 mm
Altura	288 mm
Rosca	1-3/8x16 in
V. de presión	0 psi
V. Antidrenaje	NO
Sello central	SI

APLICACIONES
CHEVROLET/FREIGHTLINER/VOLVO
INTERNATIONAL/KENWORTH



A777SP

**HD / PESADO
ACEITE
FLUJO PARCIAL**

D. Exterior	118.3 mm
Altura	288 mm
Rosca	1-3/8x16 in
V. de presión	0 psi
V. Antidrenaje	NO
Sello central	SI

APLICACIONES
CHEVROLET/FREIGHTLINER/VOLVO
INTERNATIONAL/KENWORTH



A7898SP

**MD / MEDIANO
ACEITE
FLUJO COMPLETO**

D. Exterior	93.7 mm
Altura	178 mm
Rosca	M27x2 mm
V. de presión	0 psi
V. Antidrenaje	NO
Sello central	NO

APLICACIONES
FOTON / JAC / FOTON / IVECO
YUTONG / VOLKSWAGEN



A810

**MD / MEDIANO
ACEITE
FLUJO COMPLETO**

D. Exterior	93.7 mm
Altura	129 mm
Rosca	M24x2 mm
V. de presión	8 a 11 psi
V. Antidrenaje	NO
Sello central	NO

APLICACIONES
JAC / CHENGDU



A812
MD / MEDIANO
ACEITE
FLUJO COMPLETO

D. Exterior	93.7 mm
Altura	165 mm
Rosca	M24x2 mm
V. de presión	8 a 11 psi
V. Antidrenaje	NO
Sello central	NO

APLICACIONES
CHENGDU



A840SP
MD / MEDIANO
ACEITE
FLUJO COMPLETO

D. Exterior	93.7 mm
Altura	205 mm
Rosca	1x12 in
V. de presión	30 psi
V. Antidrenaje	NO
Sello central	NO

APLICACIONES
AGRALE / FOTON / VOLKSWAGEN



A84SP
MD / MEDIANO
ACEITE
FLUJO COMPLETO

D. Exterior	93.7 mm
Altura	205 mm
Rosca	13/16x16 in
V. de presión	0 psi
V. Antidrenaje	NO
Sello central	NO

APLICACIONES
CHEVROLET



A8720CSP
LDD / LIVIANO DIÉSEL
ACEITE
FLUJO COMPLETO

D. Exterior	81.3 mm
Altura	100 mm
Rosca	M26x1.5 mm
V. de presión	8 a 11 psi
V. Antidrenaje	SI
Sello central	NO

APLICACIONES
CHEVROLET



A9003SP
HD / PESADO
ACEITE
FLUJO COMPLETO

D. Exterior	107.8 mm
Altura	196 mm
Rosca	1-1/8x16 in
V. de presión	0 psi
V. Antidrenaje	NO
Sello central	NO

APLICACIONES
NISSAN



A9025SP
HD / PESADO
ACEITE
FLUJO DUAL

D. Exterior	118.3 mm
Altura	360 mm
Rosca	M95x2 mm
V. de presión	0 psi
V. Antidrenaje	NO
Sello central	NO

APLICACIONES
INTERNATIONAL



A9035SP
HD / PESADO
ACEITE
FLUJO DUAL

D. Exterior	118.3 mm
Altura	264 mm
Rosca	M95x2 mm
V. de presión	0 psi
V. Antidrenaje	NO
Sello central	NO

APLICACIONES
INTERNATIONAL



A9080SP
HD / PESADO
ACEITE
FLUJO COMPLETO

D. Exterior	118,3 mm
Altura	302 mm
Rosca	M95x2,5
V. de presión	0 psi
V. Antidrenaje	NO
Sello central	NO

APLICACIONES
FREIGHTLINER / FOTON / VOLVO
KENWORTH



A91480
MD / MEDIANO
ACEITE
FLUJO DUAL

D. Exterior	102 mm
Altura	93 mm
Rosca	M24x1.5 mm
V. de presión	8 a 11 psi
V. Antidrenaje	SI
Sello central	NO

APLICACIONES
TOYOTA



A9797PLUS
LD / LIVIANO
ACEITE
FLUJO COMPLETO

D. Exterior	76.4 mm
Altura	97 mm
Rosca	M18x1.5 mm
V. de presión	0 psi
V. Antidrenaje	SI
Sello central	NO

APLICACIONES
CHEVROLET / DAEWOO



A9N5570SP
HD / PESADO
ACEITE
FLUJO COMPLETO

D. Exterior	93.7 mm
Altura	129 mm
Rosca	1-1/8x16 in
V. de presión	8 a 11 psi
V. Antidrenaje	NO
Sello central	NO

APLICACIONES
FORD



A9N6007SP
MD / MEDIANO
ACEITE
FLUJO COMPLETO

D. Exterior	107.8 mm
Altura	143 mm
Rosca	1-1/8x16 in
V. de presión	0 psi
V. Antidrenaje	NO
Sello central	NO

APLICACIONES
NISSAN



AL106

**MD / MEDIANO
ACEITE
FLUJO COMPLETO**

D. Exterior	136.5 mm
Altura	91 mm
Rosca	1-1/2x16 in
V. de presión	17 a 19 psi
V. Antidrenaje	SI
Sello central	NO

**APLICACIONES
VOLKSWAGEN**



AR1218

**LD / LIVIANO
ACEITE
FLUJO COMPLETO**

D. Exterior	93.7 mm
Altura	82 mm
Rosca	3/4x16 in
V. de presión	8 a 11 psi
V. Antidrenaje	SI
Sello central	NO

**APLICACIONES
DACIA / RENAULT**



AR17

**LD / LIVIANO
ACEITE
FLUJO COMPLETO**

D. Exterior	93.7 mm
Altura	T165 mm
Rosca	3/4x16 in
V. de presión	8 a 11 psi
V. Antidrenaje	SI
Sello central	NO

**APLICACIONES
MASSEY FERGUSON / PERKINS**



AR29SP

**HD / PESADO
ACEITE
FLUJO COMPLETO**

D. Exterior	128.2 mm
Altura	185 mm
Rosca	1-1/2x16 in
V. de presión	0 psi
V. Antidrenaje	NO
Sello central	NO

**APLICACIONES
KENWORTH**



AR46

**HD / PESADO
ACEITE
FLUJO COMPLETO**

D. Exterior	128.2 mm
Altura	185 mm
Rosca	1-1/2x16 in
V. de presión	0 psi
V. Antidrenaje	SI
Sello central	NO

**APLICACIONES
KENWORTH**



AR4M

**LD / LIVIANO
ACEITE
FLUJO COMPLETO**

D. Exterior	93.7 mm
Altura	64 mm
Rosca	M20x1.5 mm
V. de presión	8 a 11 psi
V. Antidrenaje	SI
Sello central	NO

**APLICACIONES
RENAULT**



AR9

**LD / LIVIANO
ACEITE
FLUJO COMPLETO**

D. Exterior	93.7 mm
Altura	83 mm
Rosca	M20x1.5 mm
V. de presión	8 a 11 psi
V. Antidrenaje	SI
Sello central	NO

**APLICACIONES
MITSUBISHI / RENAULT**



PM0011843925

**HD / PESADO
ACEITE
FLUJO COMPLETO**

D. Exterior	116 mm
Altura	224 mm
D. Interno	43 mm
D. Montura	0 mm
D. Empaque	122 mm
-	-

**APLICACIONES
MERCEDES BENZ**



PM126

**LD / LIVIANO
ACEITE
FLUJO COMPLETO**

D. Exterior	74 mm
Altura	133 mm
D. Interno	34.3 mm
D. Montura	15 mm
D. Empaque	0 mm
-	-

**APLICACIONES
NISSAN**



PM1320

**HD / PESADO
ACEITE
FLUJO PARCIAL**

D. Exterior	106 mm
Altura	167 mm
D. Interno	14.2 mm
D. Montura	0 mm
D. Empaque	0 mm
-	-

**APLICACIONES
CHEVROLET**



PM1650

**HD / PESADO
ACEITE
FLUJO COMPLETO**

D. Exterior	104 mm
Altura	185.8 mm
D. Interno	48.9 mm
D. Montura	14.2 mm
D. Empaque	0 mm
-	-

**APLICACIONES
ASIA / KIA / CHEVROLET**



PM17

**HD / PESADO
ACEITE
FLUJO PARCIAL**

D. Exterior	104 mm
Altura	185.8 mm
D. Interno	48.9 mm
D. Montura	14.2 mm
D. Empaque	0 mm
-	-

**APLICACIONES
ASIA / KIA / CHEVROLET**



PM1878100752

HD / PESADO
ACEITE
FLUJO COMPLETO

D. Exterior	104 mm
Altura	165.3 mm
D. Interno	48.9 mm
D. Montura	14.8 mm
D. Empaque	0 mm
-	-

APLICACIONES
HINO / CHEVROLET



PM197

HD / PESADO
ACEITE
FLUJO COMPLETO

D. Exterior	111 mm
Altura	230.6 mm
D. Interno	37 mm
D. Montura	0 mm
D. Empaque	0 mm
-	-

APLICACIONES
CHEVROLET / FORD



PM2200

LDD / LIVIANO DIÉSEL
ACEITE
FLUJO COMPLETO

D. Exterior	74 mm
Altura	102 mm
D. Interno	28 mm
D. Montura	0 mm
D. Empaque	0 mm
-	-

APLICACIONES
ASIA / KIA / NISSAN



PM2240

HD / PESADO
ACEITE
FLUJO PARCIAL

D. Exterior	128 mm
Altura	196 mm
D. Interno	25 mm
D. Montura	14.2 mm
D. Empaque	0 mm
-	-

APLICACIONES
CHEVROLET



PM248

HD / PESADO
ACEITE
FLUJO COMPLETO

D. Exterior	116 mm
Altura	195.5 mm
D. Interno	38.9 mm
D. Montura	0 mm
D. Empaque	0 mm
-	-

APLICACIONES
DODGE



PM3

OTROS
ACEITE
FLUJO COMPLETO

D. Exterior	92 mm
Altura	113 mm
D. Interno	15 mm
D. Montura	0 mm
D. Empaque	0 mm
-	-

APLICACIONES
ALLIS-CHALMERS / CASE



PM313

OTROS
ACEITE
FLUJO COMPLETO

D. Exterior	92 mm
Altura	116 mm
D. Interno	34 mm
D. Montura	0 mm
D. Empaque	0 mm
-	-

APLICACIONES
NEW HOLLAND / TOYOTA



PM343

HD / PESADO
ACEITE
FLUJO COMPLETO

D. Exterior	122.6 mm
Altura	245.5 mm
D. Interno	38.9 mm
D. Montura	0 mm
D. Empaque	0 mm
-	-

APLICACIONES
DODGE / INTERNATIONAL



PM4031840025

HD / PESADO
ACEITE
FLUJO COMPLETO

D. Exterior	120.4 mm
Altura	266.7 mm
D. Interno	56 mm
D. Montura	14 mm
D. Empaque	0 mm
-	-

APLICACIONES
MERCEDES BENZ



PM53103E

HD / PESADO
ACEITE
FLUJO COMPLETO

D. Exterior	128 mm
Altura	142.2 mm
D. Interno	55.4 mm
D. Montura	0 mm
D. Empaque	0 mm
-	-

APLICACIONES
ASIA / KIA



PM54236E

HD / PESADO
ACEITE
FLUJO PARCIAL

D. Exterior	128 mm
Altura	168 mm
D. Interno	14.2 mm
D. Montura	0 mm
D. Empaque	0 mm
-	-

APLICACIONES
MITSUBISHI / HYUNDAI



PM72281SP

MD / MEDIANO
ACEITE
FLUJO PARCIAL

D. Exterior	140 mm
Altura	225.6 mm
D. Interno	17.5 mm
D. Montura	0 mm
D. Empaque	0 mm
-	-

APLICACIONES
HINO

ACEITE



PM84001SP

**HD / PESADO
ACEITE
FLUJO COMPLETO**

D. Exterior	128 mm
Altura	193 mm
D. Interno	59 mm
D. Montura	0 mm
D. Empaque	0 mm
-	-

**APLICACIONES
HYUNDAI**



PM9885132652

**HD / PESADO
ACEITE
FLUJO COMPLETO**

D. Exterior	106.2 mm
Altura	247.1 mm
D. Interno	42 mm
D. Montura	14.8 mm
D. Empaque	0 mm
-	-

**APLICACIONES
CHEVROLET / MITSUBISHI**



PMX1878100501

**HD / PESADO
ACEITE
FLUJO PARCIAL**

D. Exterior	164.5 mm
Altura	325.8 mm
D. Interno	0 mm
D. Montura	1.5 mm
D. Empaque	0 mm
-	-

**APLICACIONES
ASIA / KIA**



PMX750R

**HD / PESADO
ACEITE
FLUJO PARCIAL**

D. Exterior	192 mm
Altura	386.4 mm
D. Interno	21.3 mm
D. Montura	18.6 mm
D. Empaque	0 mm
-	-

**APLICACIONES
CHEVROLET / INTERNATIONAL**



PP03009

**LDD / LIVIANO DIÉSEL
ACEITE
FLUJO COMPLETO**

D. Exterior	62 mm
Altura	127 mm
D. Interno	22 mm
D. Montura	0 mm
D. Empaque	0 mm
-	-

**APLICACIONES
SSANGYONG**



PP12010

**LD / LIVIANO
ACEITE
FLUJO COMPLETO**

D. Exterior	56 mm
Altura	118 mm
D. Interno	25 mm
D. Montura	0 mm
D. Empaque	0 mm
-	-

**APLICACIONES
CHERY**



PP12140

**HD / PESADO
ACEITE
FLUJO COMPLETO**

D. Exterior	118 mm
Altura	313 mm
D. Interno	56 mm
D. Montura	45 mm
D. Empaque	0 mm
-	-

**APLICACIONES
MERCEDES BENZ**



PP13376

**LD / LIVIANO
ACEITE
FLUJO COMPLETO**

D. Exterior	73 mm
Altura	80 mm
D. Interno	25 mm
D. Montura	0 mm
D. Empaque	0 mm
-	-

**APLICACIONES
BMW / FIAT**



PP15466

**LD / LIVIANO
ACEITE
FLUJO COMPLETO**

D. Exterior	70 mm
Altura	140 mm
D. Interno	34.2 mm
D. Montura	0 mm
D. Empaque	0 mm
-	-

**APLICACIONES
VOLKSWAGEN**



PP15562

**LDD / LIVIANO DIÉSEL
ACEITE
FLUJO COMPLETO**

D. Exterior	65.4 mm
Altura	104 mm
D. Interno	18.8 mm
D. Montura	0 mm
D. Empaque	0 mm
-	-

**APLICACIONES
VOLKSWAGEN**



PP16328

**LDD / LIVIANO DIÉSEL
ACEITE
FLUJO COMPLETO**

D. Exterior	69.5 mm
Altura	63.8 mm
D. Interno	29 mm
D. Montura	0 mm
D. Empaque	0 mm
-	-

**APLICACIONES
FORD / MAZDA**



PP17356

**LDD / LIVIANO DIÉSEL
ACEITE
FLUJO COMPLETO**

D. Exterior	101 mm
Altura	156 mm
D. Interno	26 mm
D. Montura	0 mm
D. Empaque	0 mm
-	-

**APLICACIONES
FOTON / JAC**



PP2200
LDD / LIVIANO DIÉSEL
ACEITE
FLUJO COMPLETO

D. Exterior	76.6 mm
Altura	104 mm
D. Interno	29.6 mm
D. Montura	0 mm
D. Empaque	0 mm
-	-

APLICACIONES
NISSAN



PP2200C
LDD / LIVIANO DIÉSEL
ACEITE
FLUJO COMPLETO

D. Exterior	76.6 mm
Altura	75 mm
D. Interno	29.6 mm
D. Montura	0 mm
D. Empaque	0 mm
-	-

APLICACIONES
NISSAN



PP2620SP
MD / MEDIANO
ACEITE
FLUJO COMPLETO

D. Exterior	94.8 mm
Altura	161.4 mm
D. Interno	44 mm
D. Montura	0 mm
D. Empaque	0 mm
-	-

APLICACIONES
INTERNATIONAL



PP27401
LDD / LIVIANO DIÉSEL
ACEITE
FLUJO COMPLETO

D. Exterior	71.9 mm
Altura	111 mm
D. Interno	31.5 mm
D. Montura	0 mm
D. Empaque	0 mm
-	-

APLICACIONES
HYUNDAI



PP27908
LD / LIVIANO
ACEITE
FLUJO COMPLETO

D. Exterior	82 mm
Altura	106 mm
D. Interno	38 mm
D. Montura	0 mm
D. Empaque	0 mm
-	-

APLICACIONES
BMW



PP2F000
LD / LIVIANO
ACEITE
FLUJO COMPLETO

D. Exterior	65.4 mm
Altura	131.6 mm
D. Interno	18.8 mm
D. Montura	0 mm
D. Empaque	0 mm
-	-

APLICACIONES
HYUNDAI / KIA



PP31060
LD / LIVIANO
ACEITE
FLUJO COMPLETO

D. Exterior	69 mm
Altura	80 mm
D. Interno	28 mm
D. Montura	0 mm
D. Empaque	0 mm
-	-

APLICACIONES
TOYOTA



PP358
LD / LIVIANO
ACEITE
FLUJO COMPLETO

D. Exterior	65 mm
Altura	69 mm
D. Interno	24.4 mm
D. Montura	0 mm
D. Empaque	0 mm
-	-

APLICACIONES
CITROEN / PEUGEOT



PP3C30A
LDD / LIVIANO DIÉSEL
ACEITE
FLUJO COMPLETO

D. Exterior	63 mm
Altura	104 mm
D. Interno	20 mm
D. Montura	26 mm
D. Empaque	0 mm
-	-

APLICACIONES
KIA



PP4024
LD / LIVIANO
ACEITE
FLUJO COMPLETO

D. Exterior	60 mm
Altura	55 mm
D. Interno	28 mm
D. Montura	0 mm
D. Empaque	0 mm
-	-

APLICACIONES
DAIHATSU / TOYOTA



PP40425
LD / LIVIANO
ACEITE
FLUJO COMPLETO

D. Exterior	60 mm
Altura	160 mm
D. Interno	23 mm
D. Montura	0 mm
D. Empaque	0 mm
-	-

APLICACIONES
SSANGYONG / MERCEDES BENZ



PP4780
LD / LIVIANO
ACEITE
FLUJO COMPLETO

D. Exterior	60.6 mm
Altura	140.3 mm
D. Interno	22.4 mm
D. Montura	0 mm
D. Empaque	0 mm
-	-

APLICACIONES
CITROEN / PEUGEOT

ACEITE



PP50361

LD / LIVIANO
ACEITE

FLUJO COMPLETO

D. Exterior	81 mm
Altura	168 mm
D. Interno	24 mm
D. Montura	0 mm
D. Empaque	0 mm
-	-

APLICACIONES
DAEWOO



PP6

LD / LIVIANO
ACEITE

FLUJO COMPLETO

D. Exterior	65.4 mm
Altura	72 mm
D. Interno	27 mm
D. Montura	0 mm
D. Empaque	0 mm
-	-

APLICACIONES
MAZDA



PP6705

LD / LIVIANO
ACEITE

FLUJO COMPLETO

D. Exterior	54.3 mm
Altura	87.4 mm
D. Interno	25.3 mm
D. Montura	0 mm
D. Empaque	0 mm
-	-

APLICACIONES
RENAULT



PP7181

LDD / LIVIANO DIÉSEL
ACEITE

FLUJO COMPLETO

D. Exterior	64.3 mm
Altura	115.9 mm
D. Interno	31.8 mm
D. Montura	0 mm
D. Empaque	0 mm
-	-

APLICACIONES
MERCEDES BENZ / VOLKSWAGEN



PP7181-1

LDD / LIVIANO DIÉSEL
ACEITE

FLUJO COMPLETO

D. Exterior	64 mm
Altura	115 mm
D. Interno	28.5 mm
D. Montura	0 mm
D. Empaque	0 mm
-	-

APLICACIONES
CHEVROLET / MERCEDES BENZ
DODGE / FREIGHTLINER



PP7196

LD / LIVIANO
ACEITE

FLUJO COMPLETO

D. Exterior	83 mm
Altura	170 mm
D. Interno	35 mm
D. Montura	0 mm
D. Empaque	0 mm
-	-

APLICACIONES
MERCEDES BENZ / SSANGYONG
VOLKSWAGEN



PP7199

HD / PESADO
ACEITE

FLUJO COMPLETO

D. Exterior	83.4 mm
Altura	150.4 mm
D. Interno	39.7 mm
D. Montura	9.4 mm
D. Empaque	0 mm
-	-

APLICACIONES
MERCEDES BENZ



PP7230SP

HD / PESADO
ACEITE

FLUJO COMPLETO

D. Exterior	120.8 mm
Altura	266.2 mm
D. Interno	55.4 mm
D. Montura	0 mm
D. Empaque	0 mm
-	-

APLICACIONES
FREIGHTLINER



PP72321

LDD / LIVIANO DIÉSEL
ACEITE

FLUJO COMPLETO

D. Exterior	91 mm
Altura	92 mm
D. Interno	35 mm
D. Montura	0 mm
D. Empaque	0 mm
-	-

APLICACIONES
RENAULT



PP7399

LD / LIVIANO
ACEITE

FLUJO COMPLETO

D. Exterior	64 mm
Altura	127 mm
D. Interno	28 mm
D. Montura	0 mm
D. Empaque	0 mm
-	-

APLICACIONES
VOLKSWAGEN



PP7406

LD / LIVIANO
ACEITE

FLUJO COMPLETO

D. Exterior	70 mm
Altura	147 mm
D. Interno	26 mm
D. Montura	0 mm
D. Empaque	0 mm
-	-

APLICACIONES
TOYOTA



PP79744

LD / LIVIANO
ACEITE

FLUJO COMPLETO

D. Exterior	52 mm
Altura	138 mm
D. Interno	9 mm
D. Montura	0 mm
D. Empaque	0 mm
-	-

APLICACIONES
DODGE / JEEP



PP80111

LD / LIVIANO
ACEITE
FLUJO COMPLETO

D. Exterior	67 mm
Altura	98 mm
D. Interno	14 mm
D. Montura	0 mm
D. Empaque	0 mm
-	-

APLICACIONES
SUZUKI



PP80125

LD / LIVIANO
ACEITE
FLUJO COMPLETO

D. Exterior	64 mm
Altura	74 mm
D. Interno	31 mm
D. Montura	0 mm
D. Empaque	0 mm
-	-

APLICACIONES
SKODA



PP8088

LD / LIVIANO
ACEITE
FLUJO COMPLETO

D. Exterior	62 mm
Altura	90 mm
D. Interno	35 mm
D. Montura	0 mm
D. Empaque	0 mm
-	-

APLICACIONES
CHEVROLET



PP80215

LDD / LIVIANO DIÉSEL
ACEITE
FLUJO COMPLETO

D. Exterior	64 mm
Altura	162 mm
D. Interno	17 mm
D. Montura	28 mm
D. Empaque	0 mm
-	-

APLICACIONES
CHEVROLET



PP85674

LD / LIVIANO
ACEITE
FLUJO COMPLETO

D. Exterior	57.2 mm
Altura	105.3 mm
D. Interno	27 mm
D. Montura	9.5 mm
D. Empaque	0 mm
-	-

APLICACIONES
CHEVROLET



PP88580

MD / MEDIANO
ACEITE
FLUJO COMPLETO

D. Exterior	65.3 mm
Altura	159 mm
D. Interno	17.5 mm
D. Montura	0 mm
D. Empaque	0 mm
-	-

APLICACIONES
CHEVROLET



PP9452

HD / PESADO
ACEITE
FLUJO COMPLETO

D. Exterior	80 mm
Altura	213.4 mm
D. Interno	39.6 mm
D. Montura	9.4 mm
D. Empaque	0 mm
-	-

APLICACIONES
FREIGHTLINER / MERCEDES BENZ
VOLKSWAGEN

ACEITE



ES JUSTO
LO QUE NECESITAS



**SOLUCIONES EN FILTRACIÓN
PARA TRANSPORTE MEDIANO**

Encuétranos como **Filtros Partmo** / f / @ / in / v /

partmo.com



CO-SC-CER896120

TIPS DE INSTALACIÓN FILTROS DE COMBUSTIBLE

- El combustible es el segundo componente a filtrar
- Los componentes actuales tienen tolerancias muy bajas a contaminantes
- La concentración de azufre afecta el desempeño del motor
- La presencia de combustibles alternos es un reto

FUNCIÓN DEL SISTEMA PARA FILTRACIÓN DE COMBUSTIBLE

- Remover el agua del combustible
- Remover contaminantes sólidos del combustible

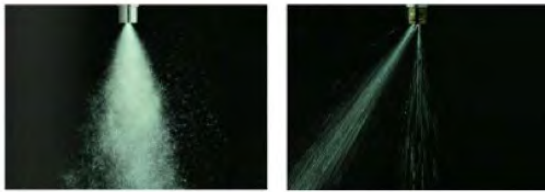

Características de la válvula de drenaje



- Facilidad de servicio - maneral de perfil ancho permite un mejor agarre
- Sencillo - se requieren menos vueltas para drenar el agua
- Te mantiene seco - el conector inferior permite agregar una manguera para drenar el agua a un contenedor

MEDIOS FILTRANTES DE USO CONVENCIONAL PARA COMBUSTIBLE

Medios filtrantes para uso en fluidos líquidos de fibras de celulosa y pequeñas proporciones de fibra sintética impregnados en resina fenólica en una gran variedad de calidades para su uso en combustible y agua, acorde a los requerimientos del equipo liviano, mediano o pesado, con características de caída mínima de presión, alta resistencia a los fluidos petrolubricantes y a los compuestos químicos de los aditivos y refrigerantes, alta memoria de plisaje, mayor capacidad y alta eficacia.



MEDIOS FILTRANTES COALESCENTES PARA SEPARADORES DE AGUA COMBUSTIBLE SUPER PREMIUM

Compuestos de fibras de celulosa impregnadas de resinas de silicona coalescentes que le transfieren la repelencia al agua necesaria en la filtración de combustibles con la más alta tecnología en separación de macromoléculas de agua incluidas en el diésel en disolución o de manera libre.

- Eficiencia: 30 micras al 50%.
- Media filtrante tratada con Silicón, lo que permite el principio de funcionamiento de Coalescencia



AGUA EMULSIONADA - EFECTOS DE LA CONTAMINACIÓN DEL DIÉSEL

- Saturación prematura del filtro
- Bombas desgastadas por fricción
- Obstrucción u oxidación de inyectores
- Aumento en el consumo del diésel
- Pérdida de potencia.
- Reparaciones constantes.

PROBLEMAS MÁS COMUNES EN FILTROS PARA DIÉSEL

- Saturación prematura por agua, contaminantes o combustibles diferentes al diésel y baja de presión de inyección
- Mala aplicación
- Instalación inadecuada
- El filtro se vacía
- Filtro sin cambio oportuno

LODOS Y ASFALTENOS COLOR NEGRO

Estado Físico:

Media filtrante refleja una apariencia color negro.

Su olor es de aceite quemado.

Causa:

El combustible utilizado ha sido mezclado con aceite quemado.

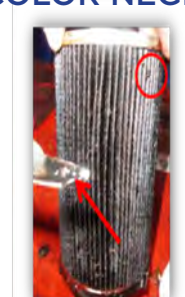

LODOS EN EXCESO

Estado Físico:

Apariencia color café.
Excesos de lodo en la media filtrante.



Causa:

Combustible y/o tanque de almacenamiento se encuentran altamente contaminados.

CRECIMIENTO MICROBIANO

Estado Físico:

Media filtrante con tonalidad café.
El filtro emana un olor fétido.



Causa:

Esta situación se debe a la utilización de un combustible altamente degradado.

DURABILIDAD PARA LOS FILTROS DE COMBUSTIBLE

Los filtros para combustible deben ser reemplazados como parte del mantenimiento preventivo y programado de un vehículo, este cambio obedece a las recomendaciones del fabricante del motor; no obstante, los filtros de combustible pueden requerir ser cambiados antes por múltiples razones de taponamiento prematuro de las unidades filtrantes.

Cuando un filtro para combustible se satura, éste ha realizado el trabajo para el cuál ha sido diseñado y por tanto puede ser considerado un filtro de buena calidad, sin embargo, el problema no se soluciona cambiando la unidad filtrante por una nueva, es necesario indagar las causas que están generando la saturación de las unidades filtrantes.

Topografías con cambios bruscos en las condiciones de operación de un vehículo, donde fácilmente en carretera los cambios de altura suceden los cambios de altura de 200 metros en fracciones de 15 minutos; además de las exigencias de mayor potencia y desempeño de los motores, las condiciones de sincronización de un vehículo difícilmente pueden considerarse las óptimas para favorecer una combustión limpia bajo estas condiciones.

Además de estas implacables condiciones de cambios de la topografía, las ciudades no se apartan de condiciones igualmente severas. Nuestras grandes urbes impactan, de manera negativa en nuestros vehículos, los cuales, trabajan en condiciones de baja temperatura por su accionar de parar-arrancar, acrecentando la generación de carbón, hollín, combustibles semiquemados, agua o refrigerante, lacas, barnices con bajo poder calórico que hace deficiente la combustión y por ende el rendimiento esperado de los motores diésel y gasolina.

Con frecuencia encontramos agua y sedimentos (lodos) incluidos en el sistema de inyección. El agua es el principal contaminante en los combustibles, su inclusión puede provenir en la cadena logística de suministro en los combustibles hasta los tanques de almacenamiento, bombas, mangueras y conductos de los mismos vehículos; que requieren buenos controles de los niveles de agua, o disponer de pre-filtros y filtros coalescentes para el suministro de combustible.

Cuando existe presencia de agua en los combustibles, como el biodiésel, se generan grandes cultivos de bacterias, hongos y contaminantes grasos, que con el agua y los lodos forman capas en las paredes de los medios filtrantes de los filtros para combustible.

Estas capas "lechosas" (mezcla de ACPM, lodos, parafinas, glicerina, bacterias y agua) generan geles en los medios filtrantes



que producen el llamado “gelado del papel fieltro” que es un taponamiento prematuro de la unidad ante la presencia de altos niveles de agua que desencadenan la acumulación de contaminantes de lodos grasos que bloquean el paso del combustible a través de los poros del medio filtrante.

Con frecuencia encontramos en la combustión generado por inclusión de aire en el sistema de inyección, con esto los niveles de combustible permanecen bajos, las exigencias del motor se ven afectadas y la potencia del mismo se reduce. Calibrar las bombas con equipos estándar, usar el filtro correcto, usar los accesorios suministrados con el filtro y un acertado mantenimiento preventivo al sistema de combustible del vehículo puede ser la diferencia entre un filtro de alta calidad y un adecuado sistema de filtración.

1. Con la falla presentada se hace necesario seguir las prácticas recomendadas por los fabricantes de motores:
2. Drenar semanalmente el filtro (para filtros con válvulas o drenajes) para retirar el agua y los lodos.
3. Purgar el sistema de combustible cada vez que el sistema de inyección ha sido asistido, reparado o se ha quedado sin combustible.
4. Cada mes o 4000 kilómetros recorridos drenar el agua y los sedimentos del tanque de combustible.

SISTEMAS DE COMBUSTIBLE EN LOS MOTORES DE COMBUSTIÓN INTERNA

Los sistemas operacionales de un vehículo, lubricación, admisión de aire, combustible, enfriamiento y escape se integran en un motor de combustión interna. El sistema de combustible en los motores es uno de las más importantes a la hora de lograr el máximo aprovechamiento de la energía del combustible.

Los combustibles más usados en este sistema es la gasolina y el diésel (ACPM), no obstante, también puede usarse gas licuado de petróleo (GLP), gas natural comprimido (GNC), gas natural licuado (GNL), propano etanol y otros.

El objetivo de un sistema de combustible en un motor de combustión interna es proporcionar la mezcla acertada de aire-combustible, hacer la mezcla de los dos componentes, dosificar o inyectar el combustible, o la mezcla en la cámara de combustión para los requerimientos del motor en las condiciones exigibles en que opere con el mejor rendimiento.

Existen tres factores incluyentes en la combustión: la temperatura, la turbulencia y el tiempo de resistencia.

La temperatura en la cámara de combustión es definitiva para obtener una combustión completa. Una mayor temperatura mejora la combustión, pero aumenta las emisiones de óxidos de nitrógeno (Nox). Una baja temperatura genera una deficiente combustión que se acompaña de altas emisiones de combustible no quemado (HC) y monóxido de carbono (CO).

La turbulencia al interior de la cámara de combustión es la forma en que se mezcla el aire junto al combustible. Una mayor turbulencia genera una mezcla más homogénea de aire-combustible que facilita la combustión completa. Los fabricantes de motores han logrado incrementar la turbulencia con cambios en el diseño de los múltiples de admisión, la forma de la cabeza del pistón, la forma de la cámara, cambios al sistema

de admisión de aire, la inclusión de turbo alimentadores o súper cargadores, etc.

El tiempo de resistencia se refiere al tiempo que la mezcla permanece en la cámara de combustión. Este tiempo está medido para que la mezcla se quemé completamente.

Fallas en cualquiera de estos tres factores generan mayor consumo de combustible, desgaste prematuro de las partes móviles del motor por la mezcla del combustible con aceite lubricante.



COMBUSTIBLE



A033

**MD / MEDIANO
COMBUSTIBLE
PRINCIPAL**

D. Exterior	74.8 mm
Altura	75 mm
Rosca	M20x1.5 mm
Sello integral	NO
Diámetro (E/S)	-

**APLICACIONES
HINO**



A034L

**MD / MEDIANO
COMBUSTIBLE
PRINCIPAL**

D. Exterior	81.3 mm
Altura	103 mm
Rosca	3/4x16 in
Sello integral	NO
Diámetro (E/S)	-

**APLICACIONES
HINO**



A1006SP

**HD / PESADO
COMBUSTIBLE
PRINCIPAL**

D. Exterior	93.7 mm
Altura	211 mm
Rosca	1x12 in
Sello integral	NO
Diámetro (E/S)	-

**APLICACIONES
HINO**



A110

**HD / PESADO
COMBUSTIBLE
PRINCIPAL**

D. Exterior	74.8 mm
Altura	75 mm
Rosca	3/4x16 in
Sello integral	NO
Diámetro (E/S)	-

**APLICACIONES
HINO / ISUZU**



A1218

**HD / PESADO
COMBUSTIBLE
SECUNDARIO**

D. Exterior	93.7 mm
Altura	205 mm
Rosca	M16x1.5 mm
Sello integral	NO
Diámetro (E/S)	-

**APLICACIONES
IVECO / KENWORTH**



A15

**HD / PESADO
COMBUSTIBLE
PRINCIPAL**

D. Exterior	93.7 mm
Altura	129 mm
Rosca	1x14 in
Sello integral	NO
Diámetro (E/S)	-

**APLICACIONES
HINO - MACK**



A150F

**HD / PESADO
COMBUSTIBLE
SECUNDARIO**

D. Exterior	107.8 mm
Altura	248 mm
Rosca	1-1/16x16 in
Sello integral	SI
Diámetro (E/S)	-

**APLICACIONES
MACK**



A1P2299

**HD / PESADO
COMBUSTIBLE
PRINCIPAL**

D. Exterior	93.7 mm
Altura	165 mm
Rosca	1x14 in
Sello integral	SI
Diámetro (E/S)	-

**APLICACIONES
FORD / INTERNATIONAL
KENWORTH / CHEVROLET**



A1R0751SP

**HD / PESADO
COMBUSTIBLE
PRINCIPAL**

D. Exterior	93.7 mm
Altura	165 mm
Rosca	7/8x14 in
Sello integral	SI
Diámetro (E/S)	-

**APLICACIONES
CHEVROLET / KENWORTH
MERCEDES BENZ**



A23251SP

**HD / PESADO
COMBUSTIBLE
SECUNDARIO**

D. Exterior	107.8 mm
Altura	204 mm
Rosca	1-1/2x12 in
Sello integral	NO
Diámetro (E/S)	-

**APLICACIONES
HINO**



A23

**HD / PESADO
COMBUSTIBLE
PRINCIPAL**

D. Exterior	93.7 mm
Altura	166 mm
Rosca	1x14 in
Sello integral	NO
Diámetro (E/S)	-

**APLICACIONES CHEVROLET/FORD
INTERNATIONAL/NISSAN/KENWORTH
HINO/FREIGHTLINER/VOLKSWAGEN**



A23A

**HD / PESADO
COMBUSTIBLE
PRINCIPAL**

D. Exterior	107.8 mm
Altura	165 mm
Rosca	1x14 in
Sello integral	NO
Diámetro (E/S)	-

**APLICACIONES
CUMMINS**



A23ASP

**HD / PESADO
COMBUSTIBLE
PRINCIPAL**

D. Exterior	107.8 mm
Altura	165 mm
Rosca	1x14 in
Sello integral	NO
Diámetro (E/S)	-

**APLICACIONES
CUMMINS**



A23L39

**HD / PESADO
COMBUSTIBLE
PRINCIPAL**

D. Exterior	93.7 mm
Altura	205 mm
Rosca	1x14 in
Sello integral	SI
Diámetro (E/S)	-

**APLICACIONES
FORD / FREIGHTLINER
INTERNATIONAL / KENWORTH**



A23L39SP

**HD / PESADO
COMBUSTIBLE
PRINCIPAL**

D. Exterior	93.7 mm
Altura	205 mm
Rosca	1x14 in
Sello integral	SI
Diámetro (E/S)	-

**APLICACIONES
FORD / FREIGHTLINER
INTERNATIONAL / KENWORTH**



A23SP

**HD / PESADO
COMBUSTIBLE
PRINCIPAL**

D. Exterior	93.7 mm
Altura	166 mm
Rosca	1x14 in
Sello integral	NO
Diámetro (E/S)	-

**APLICACIONES
CHEVROLET/FREIGHTLINER/NISSAN
INTERNATIONAL/KENWORTH/VOLKSWAGEN**



A243004

**MD / MEDIANO
COMBUSTIBLE
PRINCIPAL**

D. Exterior	81.3 mm
Altura	125 mm
Rosca	M16x1.5 mm
Sello integral	NO
Diámetro (E/S)	-

**APLICACIONES DONG FENG/FORD
FOTON/JAC/ VOLVO/INTERNATIONAL
IVECO/KENWORTH/YUTONG/VOLKSWAGEN**



A243004SP

**MD / MEDIANO
COMBUSTIBLE
PRINCIPAL**

D. Exterior	81.3 mm
Altura	125 mm
Rosca	M16x1.5 mm
Sello integral	NO
Diámetro (E/S)	-

**APLICACIONES DONG FENG/FORD
JAC/DODGE/INTERNATIONAL/FOTON
IVECO/YUTONG/VOLKSWAGEN**



A26000SP

**MD / MEDIANO
COMBUSTIBLE
SECUNDARIO**

D. Exterior	93.7 mm
Altura	166 mm
Rosca	M16x1.5 mm
Sello integral	SI
Diámetro (E/S)	-

**APLICACIONES
JAC**



A292

**MD / MEDIANO
COMBUSTIBLE
SECUNDARIO**

D. Exterior	93.7 mm
Altura	84 mm
Rosca	M20x1.5 mm
Sello integral	SI
Diámetro (E/S)	-

**APLICACIONES
MITSUBISHI**



A30

**HD / PESADO
COMBUSTIBLE
SECUNDARIO**

D. Exterior	107.8 mm
Altura	185 mm
Rosca	7/8x16 in
Sello integral	NO
Diámetro (E/S)	-

**APLICACIONES
MACK / RENAULT**



A305F

**OTROS
COMBUSTIBLE
PRINCIPAL**

D. Exterior	93.7 mm
Altura	130 mm
Rosca	M20x1.5 mm
Sello integral	NO
Diámetro (E/S)	-

**APLICACIONES
KUBOTA / BOBCAT / PERKINS**



A30SP

**HD / PESADO
COMBUSTIBLE
SECUNDARIO**

D. Exterior	107.8 mm
Altura	185 mm
Rosca	7/8x16 in
Sello integral	NO
Diámetro (E/S)	-

**APLICACIONES
MACK / RENAULT**



A31

**HD / PESADO
COMBUSTIBLE
PRINCIPAL**

D. Exterior	107.8 mm
Altura	185 mm
Rosca	13/16x18 in
Sello integral	SI
Diámetro (E/S)	-

**APLICACIONES
MACK**



A31SP

**HD / PESADO
COMBUSTIBLE
PRINCIPAL**

D. Exterior	107.8 mm
Altura	185 mm
Rosca	13/16x18 in
Sello integral	SI
Diámetro (E/S)	-

**APLICACIONES
MACK**



A33358

**HD / PESADO
COMBUSTIBLE
PRINCIPAL**

D. Exterior	74.2 mm
Altura	126 mm
Rosca	M16x1.5 mm
Sello integral	NO
Diámetro (E/S)	-

**APLICACIONES
FOTON / FORD/ FREIGHTLINER
RENAULT / SCANIA**



A33358L

**HD / PESADO
COMBUSTIBLE
PRINCIPAL**

D. Exterior	74.2 mm
Altura	145 mm
Rosca	M16x1.5 mm
Sello integral	NO
Diámetro (E/S)	-

**APLICACIONES
FOTON / FORD/ FREIGHTLINER
RENAULT / SCANIA**



A3627

**MD / MEDIANO
COMBUSTIBLE
SECUNDARIO**

D. Exterior	74.8 mm
Altura	88 mm
Rosca	3/4x16 in
Sello integral	NO
Diámetro (E/S)	-

**APLICACIONES
HINO**



A3726

**MD / MEDIANO
COMBUSTIBLE
SECUNDARIO**

D. Exterior	93.7 mm
Altura	99 mm
Rosca	M20x1.5 mm
Sello integral	NO
Diámetro (E/S)	-

**APLICACIONES
HYUNDAI / MITSUBISHI / ASIA
KIA / MAZDA**



A3726SP

**MD / MEDIANO
COMBUSTIBLE
SECUNDARIO**

D. Exterior	93.7 mm
Altura	99 mm
Rosca	M20x1.5 mm
Sello integral	NO
Diámetro (E/S)	-

**APLICACIONES
HYUNDAI / MITSUBISHI / ASIA
KIA / MAZDA**



A4023SP

**MD / MEDIANO
COMBUSTIBLE
SECUNDARIO**

D. Exterior	107.8 mm
Altura	82 mm
Rosca	1x14 in
Sello integral	NO
Diámetro (E/S)	-

**APLICACIONES
HINO**



A4047

**LDD / LIVIANO DIÉSEL
COMBUSTIBLE
SECUNDARIO**

D. Exterior	81.3 mm
Altura	75 mm
Rosca	M20x1.5 mm
Sello integral	NO
Diámetro (E/S)	-

**APLICACIONES
DAIHATSU / HYUNDAI / KUBOTA**



A4053SP

**MD / MEDIANO
COMBUSTIBLE
PRINCIPAL**

D. Exterior	81.3 mm
Altura	90 mm
Rosca	3/4x16 in
Sello integral	NO
Diámetro (E/S)	-

**APLICACIONES
CHEVROLET / FOTON / HINO / JMC
DAIHATSU / FOTON / ZHAN-QI**



A4054SP

**MD / MEDIANO
COMBUSTIBLE
SECUNDARIO**

D. Exterior	81.3 mm
Altura	76 mm
Rosca	3/4x16 in
Sello integral	NO
Diámetro (E/S)	-

**APLICACIONES
CHEVROLET / FOTON / DAIHATSU
GREAT WALL / JMC / ISUZU**



A43PSP

**OTROS
COMBUSTIBLE
SECUNDARIO**

D. Exterior	93.7 mm
Altura	130 mm
Rosca	13/16x18
Sello integral	NO
Diámetro (E/S)	-

**APLICACIONES
CASE / DAVID BROWN / DODGE**



A4618310

**OTROS
COMBUSTIBLE
SECUNDARIO**

D. Exterior	93.7 mm
Altura	165 mm
Rosca	3/4x16 in
Sello integral	NO
Diámetro (E/S)	-

**APLICACIONES
ALLIS CHALMERS**



A46SP

**HD / PESADO
COMBUSTIBLE
SECUNDARIO**

D. Exterior	93.7 mm
Altura	129 mm
Rosca	7/8x14 in
Sello integral	NO
Diámetro (E/S)	-

**APLICACIONES
NISSAN**



A48MC

**OTROS
COMBUSTIBLE
SECUNDARIO**

D. Exterior	93.7 mm
Altura	165 mm
Rosca	1x12 in
Sello integral	NO
Diámetro (E/S)	-

**APLICACIONES
VOLVO / BOLINDER**



A5138SP

**MD / MEDIANO
COMBUSTIBLE
SECUNDARIO**

D. Exterior	81.3 mm
Altura	103 mm
Rosca	3/4x16 in
Sello integral	SI
Diámetro (E/S)	-

**APLICACIONES
HINO**



A56670

**HD / PESADO
COMBUSTIBLE
PRINCIPAL**

D. Exterior	93.7 mm
Altura	165 mm
Rosca	M24x1.5 mm
Sello integral	SI
Diámetro (E/S)	-

**APLICACIONES
MITSUBISHI / HYUNDAI**



A588

**MD / MEDIANO
COMBUSTIBLE
SECUNDARIO**

D. Exterior	107.8 mm
Altura	185 mm
Rosca	7/8x14 in
Sello integral	SI
Diámetro (E/S)	-

**APLICACIONES
IHC / DNA / INTERNATIONAL**



A588SP

**HD / PESADO
COMBUSTIBLE
SECUNDARIO**

D. Exterior	107.8 mm
Altura	185 mm
Rosca	7/8x14 in
Sello integral	SI
Diámetro (E/S)	-

**APLICACIONES
IHC / DNA / INTERNATIONAL**



A614

**HD / PESADO
COMBUSTIBLE
PRINCIPAL**

D. Exterior	93.7 mm
Altura	266 mm
Rosca	1x14 in
Sello integral	SI
Diámetro (E/S)	-

**APLICACIONES
FREIGHTLINER / INTERNATIONAL
KENWORTH / MACK**



A70401SP

**HD / PESADO
COMBUSTIBLE
SECUNDARIO**

D. Exterior	93.7 mm
Altura	121 mm
Rosca	M23x1,5 mm
Sello integral	NO
Diámetro (E/S)	-

**APLICACIONES
MITSUBISHI**



A7602

**HD / PESADO
COMBUSTIBLE
SECUNDARIO**

D. Exterior	93.7 mm
Altura	129 mm
Rosca	3/4x16 in
Sello integral	NO
Diámetro (E/S)	-

**APLICACIONES
CHEVROLET**



A7614SP

**MD / MEDIANO
COMBUSTIBLE
SECUNDARIO**

D. Exterior	93.7 mm
Altura	134 mm
Rosca	3/4x16 in
Sello integral	NO
Diámetro (E/S)	-

**APLICACIONES
NISSAN**



A7629SP

**HD / PESADO
COMBUSTIBLE
PRINCIPAL**

D. Exterior	107.8 mm
Altura	204 mm
Rosca	7/8x14 in
Sello integral	SI
Diámetro (E/S)	-

**APLICACIONES
INTERNACIONAL
DETROIT DIESEL**



A7653

**HD / PESADO
COMBUSTIBLE
PRINCIPAL**

D. Exterior	93.7 mm
Altura	204 mm
Rosca	M18x1.5 mm
Sello integral	SI
Diámetro (E/S)	-

**APLICACIONES
VOLVO**

COMBUSTIBLE



A7656E

**HD / PESADO
COMBUSTIBLE
PRINCIPAL**

D. Exterior	107.8 mm
Altura	195 mm
Rosca	M22x1.5 mm
Sello integral	SI
Diámetro (E/S)	-

**APLICACIONES
MACK**



A7657

**HD / PESADO
COMBUSTIBLE
SECUNDARIO**

D. Exterior	107.8 mm
Altura	263 mm
Rosca	M30x1.5 mm
Sello integral	SI
Diámetro (E/S)	-

**APLICACIONES
MACK**



A7766SP

**HD / PESADO
COMBUSTIBLE
SECUNDARIO**

D. Exterior	93.7 mm
Altura	232 mm
Rosca	M72x2 mm
Sello integral	NO
Diámetro (E/S)	-

**APLICACIONES
KENWORTH / MACK**



A7773SP

**HD / PESADO
COMBUSTIBLE
SECUNDARIO**

D. Exterior	107.8 mm
Altura	196 mm
Rosca	M30x1.5 mm
Sello integral	NO
Diámetro (E/S)	-

**APLICACIONES
MACK**



A7813SP

**HD / PESADO
COMBUSTIBLE
PRINCIPAL**

D. Exterior	93.7 mm
Altura	232 mm
Rosca	M20x1.5 mm
Sello integral	NO
Diámetro (E/S)	-

**APLICACIONES
JAC / FOTON / INTERNATIONAL
IVECO / YUTONG**



A8000SP

**HD / PESADO
COMBUSTIBLE
PRINCIPAL**

D. Exterior	81.3 mm
Altura	101 mm
Rosca	M20x1.5 mm
Sello integral	NO
Diámetro (E/S)	-

**APLICACIONES
HYUNDAI**



A8059

**HD / PESADO
COMBUSTIBLE
SECUNDARIO**

D. Exterior	107.8 mm
Altura	263 mm
Rosca	M32x1.5 mm
Sello integral	NO
Diámetro (E/S)	-

**APLICACIONES
JAC / MACK / RENAULT / VOLVO**



A830

**MD / MEDIANO
COMBUSTIBLE
PRINCIPAL**

D. Exterior	107.8 mm
Altura	131 mm
Rosca	1x14 in
Sello integral	SI
Diámetro (E/S)	-

**APLICACIONES
VOLKSWAGEN**



A84040SP

**MD / MEDIANO
COMBUSTIBLE
SECUNDARIO**

D. Exterior	93.7 mm
Altura	178 mm
Rosca	M22x1.5 mm
Sello integral	SI
Diámetro (E/S)	-

**APLICACIONES
HYUNDAI**



A85

**OTROS
COMBUSTIBLE
SECUNDARIO**

D. Exterior	107.8 mm
Altura	248 mm
Rosca	1x14 in
Sello integral	SI
Diámetro (E/S)	-

**APLICACIONES
CATERPILLAR**



A888

**HD / PESADO
COMBUSTIBLE
SECUNDARIO**

D. Exterior	93.7 mm
Altura	205 mm
Rosca	7/8x14 in
Sello integral	SI
Diámetro (E/S)	-

**APLICACIONES
KENWORTH**



A941C

**MD / MEDIANO
COMBUSTIBLE
PRINCIPAL**

D. Exterior	81.3 mm
Altura	125 mm
Rosca	3/4x16 in
Sello integral	NO
Diámetro (E/S)	-

**APLICACIONES
CHEVROLET / NISSAN**



A941SP

**MD / MEDIANO
COMBUSTIBLE
PRINCIPAL**

D. Exterior	81.3 mm
Altura	148 mm
Rosca	3/4x16 in
Sello integral	NO
Diámetro (E/S)	-

**APLICACIONES
CHEVROLET / NISSAN**



A96

**HD / PESADO
COMBUSTIBLE
PRINCIPAL**

D. Exterior	93.7 mm
Altura	209 mm
Rosca	1x12 in
Sello integral	NO
Diámetro (E/S)	-

**APLICACIONES
CHEVROLET / FORD
FREIGHTLINER**



A96C

**HD / PESADO
COMBUSTIBLE
PRINCIPAL**

D. Exterior	93.7 mm
Altura	131 mm
Rosca	1x12 in
Sello integral	NO
Diámetro (E/S)	-

**APLICACIONES
CHEVROLET**



A96SP

**HD / PESADO
COMBUSTIBLE
PRINCIPAL**

D. Exterior	93.7 mm
Altura	209 mm
Rosca	1x12 in
Sello integral	NO
Diámetro (E/S)	-

**APLICACIONES
CHEVROLET / FORD
FREIGHTLINER**



A97

**HD / PESADO
COMBUSTIBLE
SECUNDARIO**

D. Exterior	93.7 mm
Altura	165 mm
Rosca	13/16x12 in
Sello integral	SI
Diámetro (E/S)	-

**APLICACIONES
CHEVROLET / FORD
FREIGHTLINER**



A97C

**HD / PESADO
COMBUSTIBLE
SECUNDARIO**

D. Exterior	93.7 mm
Altura	97 mm
Rosca	13/16x12 in
Sello integral	SI
Diámetro (E/S)	-

**APLICACIONES
CHEVROLET**



A97SP

**HD / PESADO
COMBUSTIBLE
SECUNDARIO**

D. Exterior	93.7 mm
Altura	165 mm
Rosca	13/16x12 in
Sello integral	SI
Diámetro (E/S)	-

**APLICACIONES
CHEVROLET / FORD
FREIGHTLINER**



P3461

**HD / PESADO
COMBUSTIBLE
PRINCIPAL**

D. Exterior	84.3 mm
Altura	115 mm
Rosca	14.5 mm
Sello integral	SI
Diámetro (E/S)	-

**APLICACIONES
FOTON / FORD / ALLIS CHALMERS
MASSEY FERGUSON**

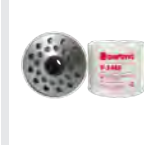

P346P

**MD / MEDIANO
COMBUSTIBLE
PRINCIPAL**

D. Exterior	84.3 mm
Altura	74 mm
Rosca	14.5 mm
Sello integral	SI
Diámetro (E/S)	-

**APLICACIONES
MAHINDRA / CASE / JOHN DEERE**



P596

**MD / MEDIANO
COMBUSTIBLE
PRINCIPAL**

D. Exterior	84.3 mm
Altura	87 mm
Rosca	14.5 mm
Sello integral	SI
Diámetro (E/S)	-

**APLICACIONES
MAZDA**



PFG324

**LD / LIVIANO
COMBUSTIBLE
PRINCIPAL**

D. Exterior	55 mm
Altura	114 mm
Rosca 1	M14x1,5
Rosca 2	M12 x 1,25
Diámetro (E/S)	-

**APLICACIONES
MITSUBISHI / DAIHATSU / TOYOTA**



PFG1058

**LD / LIVIANO
COMBUSTIBLE
PRINCIPAL**

D. Exterior	113 mm
Altura	128 mm
Rosca	-
Sello integral	NO
Diámetro (E/S)	12 mm / 16 mm

**APLICACIONES
KIA**



PFG1191

**LD / LIVIANO
COMBUSTIBLE
PRINCIPAL**

D. Exterior	69.9 mm
Altura	134 mm
Rosca 1	M12x1,25
Rosca 2	M12 x 1,25
Diámetro (E/S)	-

**APLICACIONES
TOYOTA**



PFG25121074

**LD / LIVIANO
COMBUSTIBLE
PRINCIPAL**

D. Exterior	55 mm
Altura	163.4 mm
Rosca	-
Sello integral	NO
Diámetro (E/S)	7.9 mm / 7.9 mm

**APLICACIONES
HONDA / CHANGAN / CHERY / CHEVROLET
DAEWOO / FIAT / FOTON / MAZDA**



PFG25121074C

**LD / LIVIANO
COMBUSTIBLE
PRINCIPAL**

D. Exterior	55 mm
Altura	140 mm
Rosca	-
Sello integral	NO
Diámetro (E/S)	7.9 mm / 7.9 mm

**APLICACIONES
CHEVROLET**



PFG314

**LD / LIVIANO
COMBUSTIBLE
PRINCIPAL**

D. Exterior	56,2 mm
Altura	139,7 mm
Rosca	-
Sello integral	NO
Diámetro (E/S)	8,3 mm / 8,3 mm

**APLICACIONES
FORD / MAZDA**



PFG323

**LD / LIVIANO
COMBUSTIBLE
PRINCIPAL**

D. Exterior	55.4 mm
Altura	140 mm
Rosca	-
Sello integral	NO
Diámetro (E/S)	8.6 mm / 8.6 mm

**APLICACIONES
CHEVROLET**



PFG330

**LD / LIVIANO
COMBUSTIBLE
PRINCIPAL**

D. Exterior	54.9 mm
Altura	163 mm
Rosca	-
Sello integral	NO
Diámetro (E/S)	8 mm / 8 mm

**APLICACIONES
BYD/CHEVROLET/CITROEN/GEELY/HAFEI
GREAT WALL/PEUGEOT/VOLKSWAGEN**



PFG4000

**LD / LIVIANO
COMBUSTIBLE
PRINCIPAL**

D. Exterior	66.3 mm
Altura	129 mm
Rosca	-
Sello integral	NO
Diámetro (E/S)	8.1 mm / 8.1 mm

**APLICACIONES
NISSAN**



PFG405

**LD / LIVIANO
COMBUSTIBLE
PRINCIPAL**

D. Exterior	56 mm
Altura	70 mm
Rosca	-
Sello integral	NO
Diámetro (E/S)	8 mm / 8 mm

**APLICACIONES
DAIHATSU / RENAULT**



PFG422

**LD / LIVIANO
COMBUSTIBLE
PRINCIPAL**

D. Exterior	80 mm
Altura	175 mm
Rosca	-
Sello integral	NO
Diámetro (E/S)	90 mm / 90 mm

**APLICACIONES
SSANGYONG**



PFG448

**MD / MEDIANO
COMBUSTIBLE
PRINCIPAL**

D. Exterior	98 mm
Altura	136 mm
Rosca	-
Sello integral	NO
Diámetro (E/S)	10 mm / 10 mm

**APLICACIONES
NISSAN**



PFG453

**LDD / LIVIANO DIÉSEL
COMBUSTIBLE
PRINCIPAL**

D. Exterior	95 mm
Altura	217 mm
Rosca	-
Sello integral	NO
Diámetro (E/S)	10 mm / 10 mm

**APLICACIONES
VOLKSWAGEN**



PFG454

**LDD / LIVIANO DIÉSEL
COMBUSTIBLE
PRINCIPAL**

D. Exterior	95 mm
Altura	225 mm
Rosca	-
Sello integral	NO
Diámetro (E/S)	10 mm / 10 mm

**APLICACIONES
VOLKSWAGEN**



PFG460

**LD / LIVIANO
COMBUSTIBLE
PRINCIPAL**

D. Exterior	55.6 mm
Altura	108 mm
Rosca	-
Sello integral	NO
Diámetro (E/S)	7.8 mm / 9.5 mm

**APLICACIONES
CHEVROLET**



PFG469

**LD / MEDIANO
COMBUSTIBLE
PRINCIPAL**

D. Exterior	86.5 mm
Altura	128 mm
Rosca	-
Sello integral	NO
Diámetro (E/S)	8 mm / 10 mm

**APLICACIONES
MERCEDES BENZ**



PFG516K

**LD / MEDIANO
COMBUSTIBLE
PRINCIPAL**

D. Exterior	52.5 mm
Altura	109.9 mm
Rosca	-
Sello integral	NO
Diámetro (E/S)	7.9 mm / 7.9 mm

**APLICACIONES
CHEVROLET/DAIHATSU/MAZDA
LAND ROVER/RENAULT/TOYOTA**



PFG7958

**LD / LIVIANO
COMBUSTIBLE
PRINCIPAL**

D. Exterior	88 mm
Altura	195 mm
Rosca	-
Sello integral	NO
Diámetro (E/S)	8 mm / 8 mm

**APLICACIONES
VOLKSWAGEN**



PM1878100270

**HD / PESADO
COMBUSTIBLE
SECUNDARIO**

D. Exterior	92 mm
Altura	142 mm
D. Interno	25 mm
Sello integral	SI
Diámetro (E/S)	-

**APLICACIONES
CHEVROLET / NISSAN**



PM1878100271

**HD / PESADO
COMBUSTIBLE
PRINCIPAL**

D. Exterior	110.1 mm
Altura	206.4 mm
D. Interno	50 mm
Sello integral	NO
Diámetro (E/S)	-

**APLICACIONES
CHEVROLET**



PM324E

**MD / MEDIANO
COMBUSTIBLE
SECUNDARIO**

D. Exterior	63.5 mm
Altura	112.6 mm
D. Interno	12 mm
Sello integral	NO
Diámetro (E/S)	-

**APLICACIONES
MERCEDES BENZ / FREIGHTLINER**



PM707E

**HD / PESADO
COMBUSTIBLE
PRINCIPAL**

D. Exterior	63.5 mm
Altura	112.6 mm
D. Interior	12 mm
Sello integral	NO
Diámetro (E/S)	-

**APLICACIONES
MERCEDES BENZ**



PM9760

**HD / PESADO
COMBUSTIBLE
PRINCIPAL**

D. Exterior	100 mm
Altura	162.4 mm
D. Interno	14.7 mm
Sello integral	NO
Diámetro (E/S)	-

**APLICACIONES
CHEVROLET**



PM988511911

**HD / PESADO
COMBUSTIBLE
PRINCIPAL**

D. Exterior	74 mm
Altura	113.6 mm
D. Interno	14.7 mm
Sello integral	NO
Diámetro (E/S)	-

**APLICACIONES
CHEVROLET**



PPO4041

**MD / MEDIANO
COMBUSTIBLE
FLUJO COMPLETO**

D. Exterior	80 mm
Altura	71 mm
D. Interno	17.5 mm
D. Montura	0 mm
D. Empaque	0 mm
-	-

**APLICACIONES
HINO**



PP11682

**MD / MEDIANO
COMBUSTIBLE
PRINCIPAL**

D. Exterior	89 mm
Altura	115 mm
D. Interno	24 mm
Sello integral	SI
Diámetro (E/S)	-

**APLICACIONES
HINO**



PP11690SP

**HD / PESADO
COMBUSTIBLE
SECUNDARIO**

D. Exterior	89 mm
Altura	139 mm
D. Interno	24 mm
Sello integral	SI
Diámetro (E/S)	-

**APLICACIONES
HINO**



PP176AC

**LDD / LIVIANO DIÉSEL
COMBUSTIBLE
PRIMARIO**

D. Exterior	83.6 mm
Altura	85 mm
D. Interno	12.3 mm
Sello integral	NO
Diámetro (E/S)	-

**APLICACIONES
FORD / MAZDA**



PP28970

**MD / MEDIANO
COMBUSTIBLE
PRINCIPAL**

D. Exterior	89.4 mm
Altura	114 mm
Rosca	12.1 mm
Sello integral	SI
Diámetro (E/S)	-

**APLICACIONES
CHEVROLET**



PP5706

**MD / MEDIANO
COMBUSTIBLE
PRINCIPAL**

D. Exterior	100 mm
Altura	213 mm
D. Interno	38 mm
Sello integral	NO
Diámetro (E/S)	-

**APLICACIONES
FOTON / JAC / VOLKSWAGEN**



PP7355

**LDD / LIVIANO DIÉSEL
COMBUSTIBLE
PRINCIPAL**

D. Exterior	84 mm
Altura	75.3 mm
D. Interno	9 mm
Sello integral	NO
Diámetro (E/S)	-

**APLICACIONES
CHEVROLET / TOYOTA**



PP7455

**LD / LIVIANO
COMBUSTIBLE
PRINCIPAL**

D. Exterior	95 mm
Altura	101 mm
D. Interno	0 mm
Sello integral	NO
Diámetro (E/S)	-

**APLICACIONES
SSANGYONG**



PP7476

**LDD / LIVIANO DIÉSEL
COMBUSTIBLE
PRINCIPAL**

D. Exterior	88.8 mm
Altura	110 mm
D. Interno	25 mm
Sello integral	NO
Diámetro (E/S)	-

**APLICACIONES
TOYOTA**



PP7735

**HD / PESADO
COMBUSTIBLE
PRINCIPAL**

D. Exterior	91.7 mm
Altura	100.5 mm
D. Interno	27.6 mm
Sello integral	NO
Diámetro (E/S)	-

**APLICACIONES
MERCEDES BENZ / FREIGHTLINER**



PP7761

**HD / PESADO
COMBUSTIBLE
PRINCIPAL**

D. Exterior	93.6 mm
Altura	203 mm
Rosca	45.2 mm
Sello integral	SI
Diámetro (E/S)	-

**APLICACIONES
FREIGHTLINER / MERCEDES BENZ**



PP80468

**LDD / LIVIANO DIÉSEL
COMBUSTIBLE
PRINCIPAL**

D. Exterior	88 mm
Altura	142 mm
D. Interno	11 mm
Sello integral	NO
Diámetro (E/S)	-

**APLICACIONES
RENAULT**



PP80472

**LDD / LIVIANO DIÉSEL
COMBUSTIBLE
PRINCIPAL**

D. Exterior	81 mm
Altura	161 mm
D. Interno	10 mm
Sello integral	NO
Diámetro (E/S)	-

**APLICACIONES
NISSAN / RENAULT**



ES JUSTO
LO QUE NECESITAS



**SOLUCIONES EN FILTRACIÓN
PARA TRANSPORTE MEDIANO**

Encuétranos como
Filtros Partmo / f / @ / in / v /

partmo.com



CO-SC-CER896120



TIPS DE INSTALACIÓN FILTROS SEPARADOR AGUA COMBUSTIBLE

Los filtros FWS (Fuel Water Separator) por su nomenclatura en ingles son filtros separadores agua-combustible los cuales son necesarios en algunos tipos de motores a diésel. Estos filtros difieren un poco de los filtros tradicionales de combustible y normalmente cuentan con una válvula de drenaje y un espacio para el almacenamiento del agua que se va separando a medida que se va realizando la filtración del combustible.

En algunos casos este recipiente es un tazón plástico transparente para poder monitorear la cantidad de agua desplazada que permita saber cuándo hacer el drenaje. Los filtros FWS tienen una media filtrante con un tratamiento especial de tal forma que pueda repeler las moléculas de agua. En los filtros que cuentan con una válvula de drenaje, es necesario estar realizando la evacuación del agua almacenada en el recipiente o tazón pues si el nivel del agua aumenta demasiado será forzada a pasar por el medio filtrante causando inconvenientes para el buen funcionamiento del motor y desgastes prematuros en algunas partes (como cavitación en los inyectores) que traen como consecuencia paradas repentinas e inesperadas en el funcionamiento de los motores a diésel.



Los separadores agua combustible de Partmo han sido fabricados con la más alta tecnología en la retención del agua disuelta en el Diesel. Pequeñas moléculas de agua se integran para alcanzar un peso con la capacidad para resbalar por el medio filtrante y decantarse en la zona baja del filtro donde es retirado por medios manuales a través de una válvula de drenaje. La media filtrante de estos filtros de la marca Partmo son tratadas con Resinas siliconadas transparentes de alta resistencia mecánica que permiten la retención de agua libre y emulsionada mayor del 99%.

Algunos de este tipo de filtros cuentan con un sensor electrónico que detecta la presencia de agua en el recipiente informando de forma inmediata para realizar el posterior y rápido drenaje del agua separada del combustible tal como se muestra en la siguiente figura.

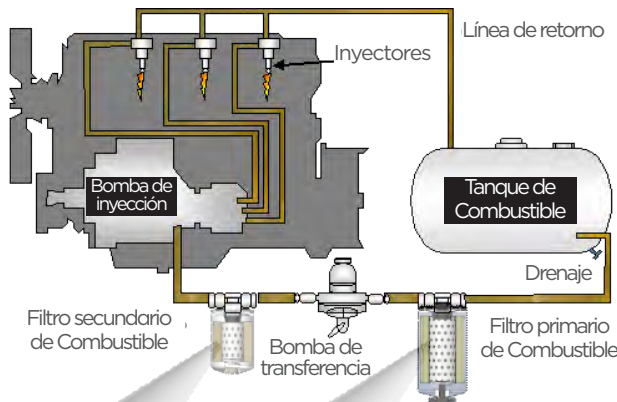



COMO SON REMOVIDAS LAS PARTÍCULAS DE AGUA EN UN FILTRO FWS?

Este proceso se explica a continuación a través de 6 pasos:

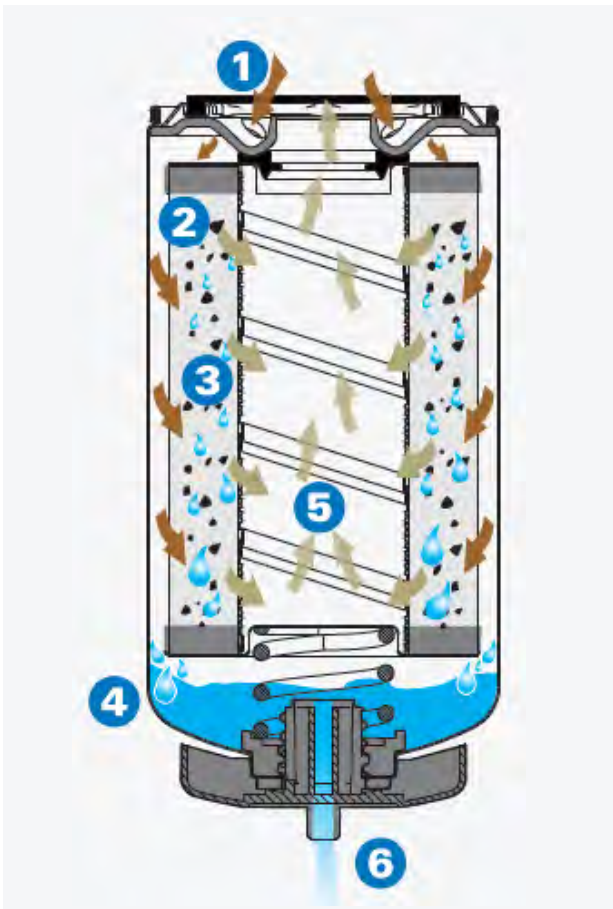

1. Entrada del combustible sucio por los orificios localizados en el disco del filtro.
2. Las partículas de contaminantes son retenidas por la media filtrante cuando el combustible pasa a través de esta.
3. El tratamiento de resina transparente de silicona repele el agua disuelta en el combustible que pasa a través de la media filtrante
4. El agua capturada se agrupa en grandes gotas que se drenan a una cavidad inferior o un tazón.
5. El combustible limpio pasa a través del cilindro central
6. El agua recolectada en el tazón o parte inferior del filtro debería ser drenada por el operador del vehículo diariamente, revisando manualmente el filtro o por dio del sensor ubicado en el panel si el filtro llegase a tener.

TIPS DE NOMENCLATURA DEL PRODUCTO PARTMO

AS - V 90 TSP

TIPO DE FILTRO
SEPARADOR AGUA
COMBUSTIBLE

- = MANUFACTURADO
_ = IMPORTADO

V = VASOVISOR
R = RACOR

T = SENSOR ELECTRÓNICO
D = VÁLVULA DE DRENAJE
SP = MEDIA FILTRANTE
SUPER PREMIUM



A093DSP

LDD / LIVIANO DIÉSEL
SEP. AGUA COMBUSTIBLE
PRINCIPAL

D. Exterior	81.3 mm
Altura	146 mm
Rosca	M20x1.5 mm
Racor	0
Sello integral	NO
Estilo	Spin ON
Tipo	Drenaje

APLICACIONES
KIA



A093SP

LDD / LIVIANO DIÉSEL
SEP. AGUA COMBUSTIBLE
PRINCIPAL

D. Exterior	81.3 mm
Altura	119 mm
Rosca	M20x1.5 mm
Rosca sensor	M22x1.5 mm
Sello integral	NO
Estilo	Spin ON
Tipo	Sensor

APLICACIONES
KIA



A11213DSP

HD / PESADO
SEP. AGUA COMBUSTIBLE
PRINCIPAL

D. Exterior	76.4 mm
Altura	109.5 mm
Rosca	M16x1,5
Racor	0
Sello integral	NO
Estilo	Spin ON
Tipo	Drenaje

APLICACIONES
BOBCAT / CASE / CUMMINS / HITACHI
FREIGHTLINER / KUBOTA / NEW HOLLAND



A1204SP

MD / MEDIANO
SEP. AGUA COMBUSTIBLE
SECUNDARIO

Flujo invertido

D. Exterior	93.7 mm
Altura	163 mm
Rosca	1x14 in
Racor	0
Sello integral	SI
Estilo	Spin ON
Tipo	Drenaje

APLICACIONES
AGRALE / MERCEDES BENZ
VOLKSWAGEN



A1205SP

MD / MEDIANO
SEP. AGUA COMBUSTIBLE
SECUNDARIO

Flujo invertido

D. Exterior	93.7 mm
Altura	156 mm
Rosca	1x14 in
Racor	0
Sello integral	SI
Estilo	Spin ON
Tipo	Drenaje

APLICACIONES
AGRALE



A1212SP

HD / PESADO
SEP. AGUA COMBUSTIBLE
PRINCIPAL

D. Exterior	93.7 mm
Altura	192 mm
Rosca	1x14 in
Racor	0
Sello integral	NO
Estilo	Spin ON
Tipo	Drenaje

APLICACIONES
FOTON / HINO / NISSAN
CHEVROLET / DINA / FORD / FREIGHTLINER
INTERNATIONAL / KENWORTH / VOLKSWAGEN



A1217

HD / PESADO
SEP. AGUA COMBUSTIBLE
PRINCIPAL

D. Exterior	93.7 mm
Altura	204.5 mm
Rosca	M14x1.5
Racor	0
Sello integral	NO
Estilo	Spin ON
Tipo	Drenaje

APLICACIONES
IVECO



A1226

MD / MEDIANO
SEP. AGUA COMBUSTIBLE
PRINCIPAL

D. Exterior	74.2 mm
Altura	175 mm
Rosca	M16x1.5 mm
Racor	0
Sello integral	NO
Estilo	Spin ON
Tipo	Drenaje

APLICACIONES
GOLDEN DRAGON



A1226LSP

MD / MEDIANO
SEP. AGUA COMBUSTIBLE
PRINCIPAL

D. Exterior	74.2 mm
Altura	175 mm
Rosca	M16x1.5 mm
Racor	0
Sello integral	NO
Estilo	Spin ON
Tipo	Drenaje

APLICACIONES
DONG FENG / CHEVROLET



A1230

MD / MEDIANO
SEP. AGUA COMBUSTIBLE
PRINCIPAL

D. Exterior	107.8 mm
Altura	134 mm
Rosca	1x14 in
Racor	0
Sello integral	SI
Estilo	Spin ON
Tipo	Drenaje

APLICACIONES
FORD



A1259SP

HD / PESADO
SEP. AGUA COMBUSTIBLE
PRINCIPAL

D. Exterior	93.7 mm
Altura	251 mm
Rosca	1x14 in
Racor	0
Sello integral	NO
Estilo	Spin ON
Tipo	Drenaje

APLICACIONES
DAEWOO / DINA / JAC / YUTONG / VOLVO
INTERNATIONAL / KENWORTH / MACK



A1285DSP

HD / PESADO
SEP. AGUA COMBUSTIBLE
PRINCIPAL

D. Exterior	93.7 mm
Altura	163 mm
Rosca	1x12 in
Racor	0
Sello integral	SI
Estilo	Spin ON
Tipo	Drenaje

APLICACIONES
CHEVROLET



A1345SP

HD / PESADO
SEP. AGUA COMBUSTIBLE
PRINCIPAL

D. Exterior	107.8 mm
Altura	170 mm
Rosca	1x14 in
Racor	0
Sello integral	SI
Estilo	Spin ON
Tipo	Drenaje

APLICACIONES

AGRALE / HINO / JAC / MERCEDES BENZ
INTERNATIONAL / VOLKSWAGEN



A1CSP

MD / MEDIANO
SEP. AGUA COMBUSTIBLE
PRINCIPAL

D. Exterior	93.7 mm
Altura	156 mm
Rosca	3/4x16 in
Racor	0
Sello integral	NO
Estilo	Spin ON
Tipo	Drenaje

APLICACIONES

NISSAN / CHEVROLET / FORD



A243004DSP

MD / MEDIANO
SEP. AGUA COMBUSTIBLE
PRINCIPAL

D. Exterior	81.3 mm
Altura	150 mm
Rosca	M16x1.5 mm
Racor	0
Sello integral	NO
Estilo	Spin ON
Tipo	Drenaje

APLICACIONES

FOTON / IVECO / JAC / DONG FENG / FAW / FORD
FREIGHTLINER / RENAUL / YUTONG / VOLKSWAGEN



A43SP

LDD / LIVIANO DIÉSEL
SEP. AGUA COMBUSTIBLE
PRINCIPAL

D. Exterior	93.7 mm
Altura	156 mm
Rosca	13/16x18 in
Racor	0
Sello integral	NO
Estilo	Spin ON
Tipo	Drenaje

APLICACIONES

DONG FENG / JAC / DODGE / FORD / FOTON
FREIGHTLINER / KENWORTH / VOLKSWAGEN



A4886

LDD / LIVIANO DIÉSEL
SEP. AGUA COMBUSTIBLE
PRINCIPAL

D. Exterior	93.7 mm
Altura	139 mm
Rosca	M20x1.5 mm
Racor	M36x1.5 mm
Sello integral	NO
Estilo	Spin ON
Tipo	Sensor

APLICACIONES

KIA / ASIA



A5368SP

LDD / LIVIANO DIÉSEL
SEP. AGUA COMBUSTIBLE
PRINCIPAL

D. Exterior	81.3 mm
Altura	176 mm
Rosca	3/4x16 in
Rosca sensor	M36x1.5 mm
Sello integral	NO
Estilo	Spin ON
Tipo	Sensor

APLICACIONES

NISSAN



A570DSP

MD / MEDIANO
SEP. AGUA COMBUSTIBLE
PRINCIPAL

D. Exterior	93.7 mm
Altura	165 mm
Rosca	M20x1.5 mm
Racor	0
Sello integral	NO
Estilo	Spin ON
Tipo	Drenaje

APLICACIONES

HYUNDAI



A5813SP

HD / PESADO
SEP. AGUA COMBUSTIBLE
PRINCIPAL

D. Exterior	93.7 mm
Altura	232 mm
Rosca	1x12 in
Racor	0
Sello integral	NO
Estilo	Spin ON
Tipo	Drenaje

APLICACIONES

CHEVROLET



A7301DSP

HD / PESADO
SEP. AGUA COMBUSTIBLE
PRINCIPAL

D. Exterior	107.8 mm
Altura	193 mm
Rosca	1x14 in
Racor	0
Sello integral	NO
Estilo	Spin ON
Tipo	Drenaje

APLICACIONES

MERCEDES BENZ / FREIGHTLINER



A7533C

LDD / LIVIANO DIÉSEL
SEP. AGUA COMBUSTIBLE
PRINCIPAL

D. Exterior	81.3 mm
Altura	85 mm
Rosca	3/4x16 in
Racor	M36x1.5 mm
Sello integral	NO
Estilo	Spin ON
Tipo	Sensor

APLICACIONES

CHEVROLET



A7533DSP

LDD / LIVIANO DIÉSEL
SEP. AGUA COMBUSTIBLE
PRINCIPAL

D. Exterior	93.7 mm
Altura	162 mm
Rosca	3/4x16 in
Racor	0
Sello integral	SI
Estilo	Spin ON
Tipo	Drenaje

APLICACIONES

MAZDA / MITSUBISHI / NISSAN / TOYOTA



A7533SP

LDD / LIVIANO DIÉSEL
SEP. AGUA COMBUSTIBLE
PRINCIPAL

D. Exterior	93.7 mm
Altura	139 mm
Rosca	3/4x16 in
Rosca sensor	M36x1.5 mm
Sello integral	SI
Estilo	Spin ON
Tipo	Sensor

APLICACIONES

NISSAN / FORD / MAZDA / MITSUBISHI
NISSAN / TOYOTA



A787

HD / PESADO
SEP. AGUA COMBUSTIBLE
PRINCIPAL

D. Exterior	93.7 mm
Altura	158 mm
Rosca	13/16x18 in
Racor	0
Sello integral	NO
Estilo	Spin ON
Tipo	Drenaje

APLICACIONES
FOTON



A915

HD / PESADO
SEP. AGUA COMBUSTIBLE
PRINCIPAL

D. Exterior	107.8 mm
Altura	214 mm
Rosca	1x12 in
Racor	0
Sello integral	NO
Estilo	Spin ON
Tipo	Drenaje

APLICACIONES
SURTIDORES DE COMBUSTIBLE



A950DSP

MD / MEDIANO
SEP. AGUA COMBUSTIBLE
PRINCIPAL

D. Exterior	93.7 mm
Altura	226.3 mm
Rosca	1x14
Racor	0
Sello integral	NO
Estilo	Spin ON
Tipo	Drenaje

APLICACIONES
VOLKSWAGEN



AK570SP

MD / MEDIANO
SEP. AGUA COMBUSTIBLE
PRINCIPAL

Flujo invertido

D. Exterior	93.7 mm
Altura	139 mm
Rosca	M20x1.5 mm
Rosca sensor	M36x1.5 mm
Sello integral	NO
Estilo	Spin ON
Tipo	Sensor

APLICACIONES
CHEVROLET / HYUNDAI / TOYOTA / ASIA
DAIHATSU / KIA / MITSUBISHI / JAC



AR16SP

HD / PESADO
SEP. AGUA COMBUSTIBLE
PRINCIPAL

D. Exterior	93.7 mm
Altura	156 mm
Rosca	1x14 in
Racor	0
Sello integral	NO
Estilo	Spin ON
Tipo	Drenaje

APLICACIONES
KENWORTH



AR90D

MD / MEDIANO
SEP. AGUA COMBUSTIBLE
PRINCIPAL

D. Exterior	107.8 mm
Altura	223 mm
Rosca	1x14 in
Racor	0
Sello integral	NO
Estilo	Spin ON
Tipo	Drenaje

APLICACIONES
FOTON



AS1003SP

HD / PESADO
SEP. AGUA COMBUSTIBLE
PRINCIPAL

D. Exterior	93.7 mm
Altura	258 mm
Rosca	1x14 in
Racor	0
Sello integral	NO
Estilo	Spin ON
Tipo	Sensor - Drenaje

APLICACIONES
KENWORTH



AS103SP

MD / MEDIANO
SEP. AGUA COMBUSTIBLE
PRINCIPAL

D. Exterior	74.8 mm
Altura	152 mm
Rosca	M20x1.5 mm
Racor	0
Sello integral	NO
Estilo	Spin ON
Tipo	Drenaje

APLICACIONES
JAC



AS1040SP

HD / PESADO
SEP. AGUA COMBUSTIBLE
PRINCIPAL

D. Exterior	118.3 mm
Altura	298 mm
Rosca	M85x2 mm
Racor	0
Sello integral	SI
Estilo	Spin ON
Tipo	Drenaje

APLICACIONES
FOTON



AS11001SP

HD / PESADO
SEP. AGUA COMBUSTIBLE
PRINCIPAL

D. Exterior	107.8 mm
Altura	161 mm
Rosca	1x14 in
Racor	0
Sello integral	NO
Estilo	Spin ON
Tipo	Vaso Visor

APLICACIONES
VOLVO



AS12226SP

HD / PESADO
SEP. AGUA COMBUSTIBLE
PRINCIPAL

D. Exterior	93.7 mm
Altura	171 mm
Rosca	M16x1.5 mm
Racor	0
Sello integral	NO
Estilo	Spin ON
Tipo	Sensor

APLICACIONES
JAC



AS12228DSP

HD / PESADO
SEP. AGUA COMBUSTIBLE
PRINCIPAL

D. Exterior	93.7 mm
Altura	195 mm
Rosca	M16x1.5 mm
Racor	0
Sello integral	NO
Estilo	Spin ON
Tipo	Drenaje

APLICACIONES
JAC



AS12228SP

HD / PESADO
SEP. AGUA COMBUSTIBLE
PRINCIPAL

D. Exterior	93.7 mm
Altura	195 mm
Rosca	M16x1.5 mm
Racor	0
Sello integral	NO
Estilo	Spin ON
Tipo	Sensor

APLICACIONES
JAC



AS1228SP

MD / MEDIANO
SEP. AGUA COMBUSTIBLE
PRINCIPAL

D. Exterior	107.8 mm
Altura	164 mm
Rosca	1x14 in
Rosca sensor	M36x1.5 mm
Sello integral	SI
Estilo	Spin ON
Tipo	Sensor

APLICACIONES
JAC



AS1249SP

MD / MEDIANO
SEP. AGUA COMBUSTIBLE
PRINCIPAL

D. Exterior	93.7 mm
Altura	168 mm
Rosca	1x14 in
Racor	1-1/4x10 in
Sello integral	NO
Estilo	Spin ON
Tipo	Vaso visor

APLICACIONES
JAC / FORD



AS1282SP

LDD / LIVIANO DIÉSEL
SEP. AGUA COMBUSTIBLE
PRINCIPAL

D. Exterior	93.7 mm
Altura	177 mm
Rosca	1x14 in
Racor	1-1/4x10 in
Sello integral	NO
Estilo	Spin ON
Tipo	Vaso visor

APLICACIONES
FORD / NISSAN / JAC



AS1441SP

MD / MEDIANO
SEP. AGUA COMBUSTIBLE
PRINCIPAL

D. Exterior	107.8 mm
Altura	131 mm
Rosca	1x14 in
Racor	3-3/4x10 in
Sello integral	NO
Estilo	Spin ON
Tipo	Vaso visor

APLICACIONES
HINO / MITSUBISHI / FREIGHTLINER
MERCEDES BENZ / VOLKSWAGEN



AS200SP

LDD / LIVIANO DIÉSEL
SEP. AGUA COMBUSTIBLE
PRINCIPAL

D. Exterior	81.3 mm
Altura	166 mm
Rosca	M16x1.5 mm
Rosca sensor	M12x1.5 mm
Sello integral	NO
Estilo	Spin ON
Tipo	Sensor

APLICACIONES
HYUNDAI / GREAT WALL / JIMBEI / JAC
GOLDEN DRAGON
FOTON / IVECO / KIA / MAHINDRA



AS201SP

LDD / LIVIANO DIÉSEL
SEP. AGUA COMBUSTIBLE
PRINCIPAL

D. Exterior	81.3 mm
Altura	143 mm
Rosca	M16x1.5 mm
Rosca sensor	M12x1.25 mm
Sello integral	NO
Estilo	Spin ON
Tipo	Sensor

APLICACIONES
HYUNDAI / KIA / JAC



AS24030SP

HD / PESADO
SEP. AGUA COMBUSTIBLE
PRINCIPAL

D. Exterior	107.8 mm
Altura	128 mm
Rosca	1x14 in
Rosca sensor	0
Sello integral	NO
Estilo	Spin ON
Tipo	Vaso Visor

APLICACIONES
NISSAN



AS27177JSP

HD / PESADO
SEP. AGUA COMBUSTIBLE
PRINCIPAL

D. Exterior	107.8 mm
Altura	214 mm
Rosca	1x14
Racor	3-3/4"x10
Sello integral	NO
Estilo	Spin ON
Tipo	Vaso Visor

APLICACIONES
MERCEDES BENZ / VOLKSWAGEN



AS3202SP

HD / PESADO
SEP. AGUA COMBUSTIBLE
PRINCIPAL

D. Exterior	93.7 mm
Altura	189 mm
Rosca	1x12 in
Racor	3x10 in
Sello integral	NO
Estilo	Spin ON
Tipo	Vaso visor

APLICACIONES
CHEVROLET



AS36209SP

LDD / LIVIANO DIÉSEL
SEP. AGUA COMBUSTIBLE
PRINCIPAL

D. Exterior	93.7 mm
Altura	203 mm
Rosca	M20x1,5
Racor	0
Sello integral	NO
Estilo	Spin ON
Tipo	Sensor - Drenaje

APLICACIONES
JAC



AS36268SP

MD / MEDIANO
SEP. AGUA COMBUSTIBLE
PRINCIPAL

D. Exterior	93.7 mm
Altura	202.6 mm
Rosca	M20x1.5
Racor	0
Sello integral	SI
Estilo	Spin ON
Tipo	Sensor - Drenaje

APLICACIONES
FOTON



AS46018SP

MD / MEDIANO
SEP. AGUA COMBUSTIBLE
PRINCIPAL

D. Exterior	107.8 mm
Altura	121 mm
Rosca	1x14 in
Racor	3X3/4x10 in
Sello integral	SI
Estilo	Spin ON
Tipo	Vaso visor

APLICACIONES
INTERNATIONAL / NISSAN



AS4654SP

HD / PESADO
SEP. AGUA COMBUSTIBLE
PRINCIPAL

D. Exterior	93.7 mm
Altura	143 mm
Rosca	1x14 in
Racor	3x10 in
Sello integral	NO
Estilo	Spin ON
Tipo	Vaso visor

APLICACIONES
VOLVO



AS5850SP

HD / PESADO
SEP. AGUA COMBUSTIBLE
PRINCIPAL

D. Exterior	107.8 mm
Altura	161 mm
Rosca	1x14 in
Racor	3-3/4x10 in
Sello integral	SI
Estilo	Spin ON
Tipo	Vaso visor

APLICACIONES
HYUNDAI / FREIGHTLINER



AS830SP

HD / PESADO
SEP. AGUA COMBUSTIBLE
PRINCIPAL

D. Exterior	107.8 mm
Altura	130 mm
Rosca	1x14 in
Racor	3x12 in
Sello integral	SI
Estilo	Spin ON
Tipo	Vaso visor

APLICACIONES
INTERNATIONAL



AS950SP

HD / PESADO
SEP. AGUA COMBUSTIBLE
PRINCIPAL

D. Exterior	93.7 mm
Altura	171 mm
Rosca	1x14 in
Racor	1-1/4x10 in
Sello integral	SI
Estilo	Spin ON
Tipo	Vaso visor

Flujo invertido

APLICACIONES
VOLKSWAGEN



ASR45SP

MD / MEDIANO
SEP. AGUA COMBUSTIBLE
PRINCIPAL

D. Exterior	107.8 mm
Altura	104 mm
Rosca	1x14 in
Racor	3-3/4x10 in
Sello integral	SI
Estilo	Spin ON
Tipo	Vaso visor

APLICACIONES
AGRALE



ASR90TDSP

MD / MEDIANO
SEP. AGUA COMBUSTIBLE
PRINCIPAL

D. Exterior	107.8 mm
Altura	194 mm
Rosca	1x14 in
Racor	M12x1.5
Sello integral	NO
Estilo	Spin ON
Tipo	Vaso visor

APLICACIONES CHEVROLET / FOTON
HINO / FREIGHTLINER / MERCEDES BENZ
SCANIA / YUTONG



ASR90TSP

MD / MEDIANO
SEP. AGUA COMBUSTIBLE
PRINCIPAL

D. Exterior	107.8 mm
Altura	158 mm
Rosca	1x14 in
Racor	3-3/4x10 in
Sello integral	NO
Estilo	Spin ON
Tipo	Vaso visor

APLICACIONES CHEVROLET / FOTON
HINO / FREIGHTLINER / MERCEDES BENZ
SCANIA / YUTONG



ASV1040SP

MD / MEDIANO
SEP. AGUA COMBUSTIBLE
PRINCIPAL

D. Exterior	107.8 mm
Altura	189 mm
Rosca	1 X 14 in
Racor	0
Sello integral	NO
Estilo	Spin ON
Tipo	Vaso visor integrado

APLICACIONES
AGRALE / FORD / IVECO / MERCEDES BENZ
RENAULT / VOLKSWAGEN



ASV1060SP

HD / PESADO
SEP. AGUA COMBUSTIBLE
PRINCIPAL

D. Exterior	107.8 mm
Altura	245 mm
Rosca	1x12 in
Racor	0
Sello integral	NO
Estilo	Spin ON
Tipo	Vaso visor integrado

APLICACIONES
MERCEDES BENZ



ASV1212SP

HD / PESADO
SEP. AGUA COMBUSTIBLE
PRINCIPAL

D. Exterior	93.7 mm
Altura	239 mm
Rosca	1x14 in
Racor	0
Sello integral	NO
Estilo	Spin ON
Tipo	Vaso visor integrado

APLICACIONES
HINO / CHEVROLET / FORD / FREIGHTLINER
INTERNATIONAL / KENWORTH



ASV1282SP

MD / MEDIANO
SEP. AGUA COMBUSTIBLE
PRINCIPAL

D. Exterior	93.7 mm
Altura	117 mm
Rosca	1x14 in
Racor	0
Sello integral	NO
Estilo	Spin ON
Tipo	Vaso visor integrado

APLICACIONES
FORD / NISSAN



ASV60TSP

MD / MEDIANO
SEP. AGUA COMBUSTIBLE
PRINCIPAL

D. Exterior	107.8 mm
Altura	206 mm
Rosca	1x14 in
Racor	0
Sello integral	NO
Estilo	Spin ON
Tipo	Vaso visor integrado

APLICACIONES
VOLKSWAGEN



ASV90TSP

HD / PESADO
SEP. AGUA COMBUSTIBLE
PRINCIPAL

D. Exterior	107.8 mm
Altura	245 mm
Rosca	1x14 in
Racor	0
Sello integral	NO
Estilo	Spin ON
Tipo	Vaso visor integrado

APLICACIONES
SCANIA / YUTONG / FOTON
HINO / KENWORTH



PM1730SP

HD / PESADO
SEP. AGUA COMBUSTIBLE
PRINCIPAL

D. Exterior	94.5 mm
Altura	193 mm
D. Interno	27.6 mm
Racor	-
Sello integral	NO
Tipo	Cartucho
Línea	Malla

APLICACIONES
HINO



PM1940

HD / PESADO
SEP. AGUA COMBUSTIBLE
PRINCIPAL

D. Exterior	94.5 mm
Altura	99 mm
D. Interno	-
Racor	-
Sello integral	NO
Tipo	Cartucho
Línea	Vaso Visor

APLICACIONES
CHEVROLET / HINO / MITSUBISHI



PM19624SP

HD / PESADO
SEP. AGUA COMBUSTIBLE
PRINCIPAL

D. Exterior	95 mm
Altura	180 mm
D. Interno	16.7 mm
Racor	-
Sello integral	NO
Tipo	Cartucho
Línea	Malla

APLICACIONES
INTERNATIONAL / CUMMINS



PM19765SP

HD / PESADO
SEP. AGUA COMBUSTIBLE
PRINCIPAL

D. Exterior	106 mm
Altura	181 mm
D. Interno	16.7 mm
Racor	-
Sello integral	NO
Tipo	Cartucho
Línea	Malla

APLICACIONES
KENWORTH



PM19915SP

HD / PESADO
SEP. AGUA COMBUSTIBLE
PRINCIPAL

D. Exterior	148 mm
Altura	193 mm
D. Interno	26 mm
Racor	-
Sello integral	NO
Tipo	Cartucho
Línea	Vaso Visor

APLICACIONES
FREIGHTLINER



PM6630

MD / MEDIANO
SEP. AGUA COMBUSTIBLE
PRINCIPAL

D. Exterior	74.6 mm
Altura	46.5 mm
D. Interno	10.3 mm
Racor	-
Sello integral	NO
Tipo	Cartucho
Línea	Malla

APLICACIONES
JMC / SSANGYONG



PM7680

HD / PESADO
SEP. AGUA COMBUSTIBLE
PRINCIPAL

D. Exterior	94.5 mm
Altura	180.4 mm
D. Interno	16.7 mm
Racor	-
Sello integral	NO
Tipo	Cartucho
Línea	Malla

APLICACIONES
FREIGHTLINER / INTERNATIONAL
KENWORTH



PP1112

MD / MEDIANO
SEP. AGUA COMBUSTIBLE
PRINCIPAL

D. Exterior	78.7 mm
Altura	90.7 mm
D. Interno	12 mm
Racor	-
Sello integral	SI
Tipo	Cartucho
Línea	Plástico

APLICACIONES
HINO



PP13110

MD / MEDIANO
SEP. AGUA COMBUSTIBLE
PRINCIPAL

D. Exterior	79.5 mm
Altura	79.8 mm
D. Interno	17 mm
Racor	-
Sello integral	SI
Tipo	Cartucho
Línea	Vaso Visor

APLICACIONES
HINO



PP19684SP

MD / MEDIANO
SEP. AGUA COMBUSTIBLE
PRINCIPAL

D. Exterior	79.5 mm
Altura	79.8 mm
D. Interno	17 mm
Racor	-
Sello integral	SI
Tipo	Cartucho
Línea	Vaso Visor

APLICACIONES
HINO



PP19925

LDD / LIVIANO DIÉSEL
SEP. AGUA COMBUSTIBLE
PRINCIPAL

D. Exterior	81 mm
Altura	127 mm
D. Interno	30 mm
Racor	-
Sello integral	NO
Tipo	Cartucho
Línea	Plástico

APLICACIONES
FOTON



PP201010

MD / MEDIANO
SEP. AGUA COMBUSTIBLE
PRINCIPAL

D. Exterior	79 mm
Altura	74 mm
D. Interno	16.6 mm
Racor	-
Sello integral	NO
Tipo	Cartucho
Línea	Plástico

APLICACIONES
NISSAN



PP201030

MD / MEDIANO
SEP. AGUA COMBUSTIBLE
PRINCIPAL

D. Exterior	79 mm
Altura	76 mm
D. Interno	16.6 mm
Racor	-
Sello integral	NO
Tipo	Cartucho
Línea	Plástico

APLICACIONES
NISSAN / MERCEDES BENZ



PP202010SP

MD / MEDIANO
SEP. AGUA COMBUSTIBLE
PRINCIPAL

D. Exterior	111.5 mm
Altura	244.8 mm
D. Interno	20.8 mm
Racor	-
Sello integral	NO
Tipo	Cartucho
Línea	Vaso Visor

APLICACIONES
FREIGHTLINER



PP202030

HD / PESADO
SEP. AGUA COMBUSTIBLE
PRINCIPAL

D. Exterior	111.5 mm
Altura	244.8 mm
D. Interno	20.8 mm
Racor	-
Sello integral	NO
Tipo	Cartucho
Línea	Plástico

APLICACIONES
HINO / KENWORTH / IHC

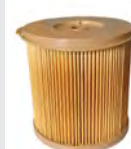

PP204010SP

HD / PESADO
SEP. AGUA COMBUSTIBLE
PRINCIPAL

D. Exterior	111.5 mm
Altura	118 mm
D. Interno	21.6 mm
Racor	-
Sello integral	NO
Tipo	Cartucho
Línea	Vaso Visor

APLICACIONES
MERCEDES BENZ / SCANIA / VOLVO



PP204030

HD / PESADO
SEP. AGUA COMBUSTIBLE
PRINCIPAL

D. Exterior	111.5 mm
Altura	118 mm
D. Interno	21.6 mm
Racor	-
Sello integral	NO
Tipo	Cartucho
Línea	Plástico

APLICACIONES
MERCEDES BENZ



PP22135

HD / PESADO
SEP. AGUA COMBUSTIBLE
PRINCIPAL

D. Exterior	111.5 mm
Altura	118 mm
D. Interno	21.6 mm
Racor	-
Sello integral	NO
Tipo	Cartucho
Línea	Plástico

APLICACIONES
MERCEDES BENZ



PP24811

HD / PESADO
SEP. AGUA COMBUSTIBLE
PRINCIPAL

D. Exterior	104 mm
Altura	192.6 mm
D. Interno	28 mm
Racor	-
Sello integral	SI
Tipo	Cartucho
Línea	Vaso Visor

APLICACIONES
CHEVROLET / ISUZU



PP7751

MD / MEDIANO
SEP. AGUA COMBUSTIBLE
PRINCIPAL

D. Exterior	104.8 mm
Altura	110.3 mm
D. Interno	20.2 mm
Racor	-
Sello integral	NO
Tipo	Cartucho
Línea	Plástico

APLICACIONES
HINO / TOYOTA



PP7777SP

HD / PESADO
SEP. AGUA COMBUSTIBLE
PRINCIPAL

D. Exterior	86 mm
Altura	104 mm
D. Interno	20 mm
Racor	-
Sello integral	SI
Tipo	Cartucho
Línea	Vaso Visor

APLICACIONES
INTERNATIONAL



PP78091SP

MD / MEDIANO
SEP. AGUA COMBUSTIBLE
PRINCIPAL

D. Exterior	78.3 mm
Altura	145.4 mm
D. Interno	12 mm
Racor	-
Sello integral	SI
Tipo	Cartucho
Línea	Plástico

APLICACIONES
HINO



PP79915SP

LDD / LIVIANO DIÉSEL
SEP. AGUA COMBUSTIBLE

PRINCIPAL

D. Exterior	94 mm
Altura	198 mm
D. Interno	44 mm
Racor	-
Sello integral	SI
Tipo	Cartucho
Línea	Vaso Visor

APLICACIONES
MERCEDES BENZ



PP808010

LDD / LIVIANO DIÉSEL
SEP. AGUA COMBUSTIBLE

PRINCIPAL

D. Exterior	94.8 mm
Altura	79.5 mm
D. Interno	40.6 mm
Racor	-
Sello integral	NO
Tipo	Cartucho
Línea	Plástico

APLICACIONES
MERCEDES BENZ



ES JUSTO
LO QUE NECESITAS



**SOLUCIONES EN FILTRACIÓN
PARA TRANSPORTE MEDIANO**

Encuétranos como
Filtros Partmo / f / @ / in / v /

partmo.com



CO-SC-CER896120



TIPS DE INSTALACIÓN FILTROS PARA REFRIGERANTE

Los motores de combustión interna generan en su operación normal, calor. Las temperaturas de combustión pueden llegar a los 1900° C. De esta temperatura, solo un 33 % se convierte en energía potencia útil, un 30% se descarga en los gases de escape, un 7% pasa directamente de la superficie del motor a la atmósfera y el 30% restante, se disipa con el sistema de enfriamiento.

Controlar la temperatura del motor es necesario para evitar daños prematuros al motor, tener un consumo de combustible controlado, mantener la potencia del motor en su máximo rendimiento, y no tener problemas de pre-ignición o detonación, entre otros.

Los motores diésel modernos mantienen un sistema de enfriamiento para controlar la temperatura en las válvulas de admisión, los cilindros, los pistones y la cámara de combustión.

Con un buen refrigerante, que por sus características lo hacen un elemento que permite reducir la formación de espuma, reducir la cavitación y evitar la corrosión. Este fluido a base de Etylen Glycol actúa mezclándolo con agua de acuerdo a las proporciones definidas por el fabricante. Este refrigerante provee condiciones para mantener una temperatura controlada en el motor y permitir la evacuación mas rápida de calor.

CARACTERÍSTICAS DE LOS FILTROS PARTMO PARA SISTEMAS DE ENFRIAMIENTO DE LOS MOTORES DIESEL:

Una unidad filtrante para sistemas refrigerantes esta fabricada con medios filtrantes con tratamiento de resinas de melamina capaz de resistir el paso permanente de liquido refrigerante sin deformar su fibra manteniendo una filtración activa durante su vida de servicio, a la vez que retiene gran cantidad de lodos (acumulación de contaminantes por oxidación y corrosión), herrumbre (por procesos de oxidación), material de incrustaciones (sales minerales); material corroído de hierro, acero y aluminio por altos grados de acidez; material de picaduras de cilindros, espumas y material de cavitaciones provenientes del circuito de enfriamiento del motor para mantener un sistema de enfriamiento libre de altos grados de contaminantes que puedan incidir en la libre circulación del refrigerante y el daño de componentes del motor.

Las unidades filtrantes para refrigerantes de Partmo están dotadas de una cámara porta pastillas donde se almacenan una o dos unidades de compuestos anticongelantes y acondicionador compatibles con inhibidores de corrosión y aditivos a base de SCA (Fosfatos, nitratos y molibdatos) o a base de Etylen Glycol.

Estas pastillas protegen la unidad filtrante contra la formación de herrumbre y oxido dando gradualmente un refuerzo al fluido refrigerante del sistema al paso por la unidad filtrante durante la operación del motor.

Las pastillas de anticongelante y acondicionador han sido fabricadas con componentes hidrosfópicos que asimilan el aire

del ambiente humectando los gránulos de los componentes que al estar en la cámara del porta pastillas se mantiene en la misma, manteniendo libre la válvula de control de flujo de la unidad contenida en el orificio roscado de la unidad. En operación su cámara porta pastillas localizada al fondo de la unidad le permite dosificar gradualmente el anticongelante y acondicionador de manera controlada.

De igual manera, próximamente a las unidades filtrantes para refrigerantes, se le les incorporara un protector en la rosca para evitar el ingreso de aire por el centro de la unidad y la contaminación externa en su manipulación. Este protector deberá ser retirado en el momento de la instalación de la unidad. Con lo anterior, los Filtros para refrigerantes de Partmo están diseñados para darle mayor tiempo de exposición antes de su uso.

Proteger el sistema contra fugas del fluido es fundamental en el sistema de enfriamiento, localizar y eliminar las fugas debe ser un propósito permanente en la operación de un motor diésel. En un sistema de enfriamiento con tapas de 10 libras por pulgada cuadrada (psi) deberá presurizarse el sistema para localizar fugas a 14 psi, y para el caso de tapas con presión de 15 psi la presurización debe alcanzar las 18 psi.

Es importante evitar el uso del agua sola como fluido de enfriamiento; esto es una muy mala práctica que deteriora el desempeño del motor, pues acelera la formación de lodos y la generación de fallas en los componentes de motor por cavitación y oxidación.

Un control al PH puede mantener un sistema activo para proteger el motor al paso del fluido refrigerante, una sustancia altamente alcalina con PH superior a 10.5 puede atacar los componentes de aluminio y cobre, mientras una sustancia ácida ataca los componentes de materiales ferrosos. Idealmente un fluido refrigerante debe mantenerse entre 8.5 y 10.5 asistiéndose con SCA en la medida que se desgasta.

En conclusión, un sistema de enfriamiento en un motor diésel requiere verificar la ausencia de fugas, el estado y mantenimiento de sus componentes, una correcta operación de el termostato, un nivel y concentración acertado del refrigerante y un filtro para sistemas de enfriamiento en motores diésel de especificaciones acorde a los requerimientos del motor.

Para una mayor protección en el sistema de enfriamiento de los motores de combustión interna Diésel, use Filtros para refrigerantes con medios filtrantes especializados de Alta eficiencia, durabilidad, Diseñados para dosificar gradualmente el liquido anticongelante durante la vida de servicio de la unidad, compatible con refrigerantes a base de SCA y ethylen glicol.

Filtros del Sistema de Refrigeración

Se estima que 40 - 50% del tiempo de inactividad del motor es debido a la falla del sistema de refrigerante. Las Fallas del sistema de refrigeración son inevitables. Con los motores diesel de hoy es necesario la disipación de mas calor, el cuidado del sistema de enfriamiento se ha vuelto incluso más importante que antes. El refrigerante de tu motor batalla con la oxidación, formación de



escamas, acidez, espuma y reducción de silicato mientras trabaja para transferir calor hacia afuera y mantener las condiciones de funcionamiento adecuadas y optimas que permitan la economía de combustible.

Las condiciones del sistema de refrigeración deben ser revisadas con frecuencia para asegurar que el equilibrio químico del refrigerante sea el adecuado.

Es fundamental que comprenda la composición exacta de refrigerante en su motor. El tipo de químico es muy específico para el trabajo y el entorno operativo.

Consideraciones del sistema de refrigerante

- ¿Tiene refrigerante tradicional que requiere adictivos?
- ¿Tiene un refrigerante a base de ácido orgánico?
- ¿Tiene un refrigerante especial que le permite trabajar un servicio extendido?

Hay muchas opciones comerciales disponibles en el mercado para refrigerantes de acuerdo a los requerimientos de cada motor. Entre las opciones mas populares para sistemas refrigerantes están aquellas con base en ácidos orgánicos o refrigerantes de tipo tradicional.

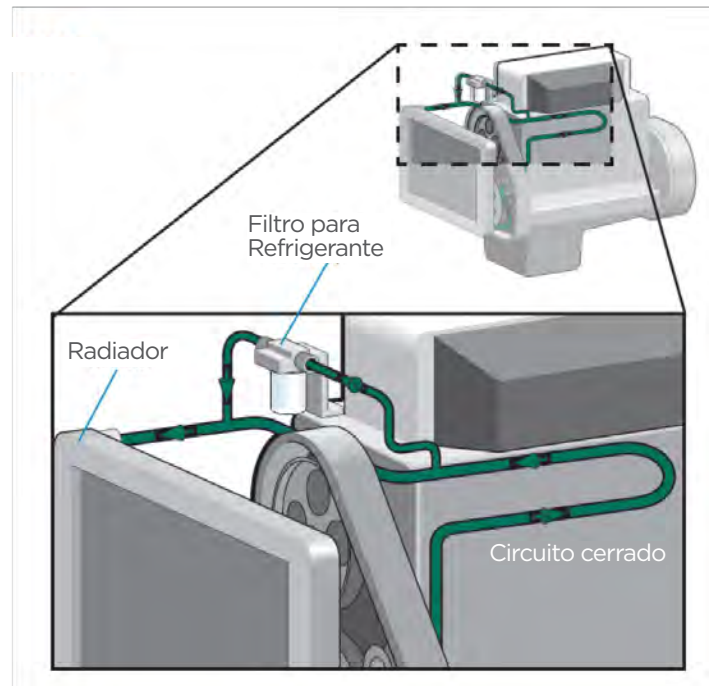

PARTES DEL FILTRO PARA REFRIGERANTE

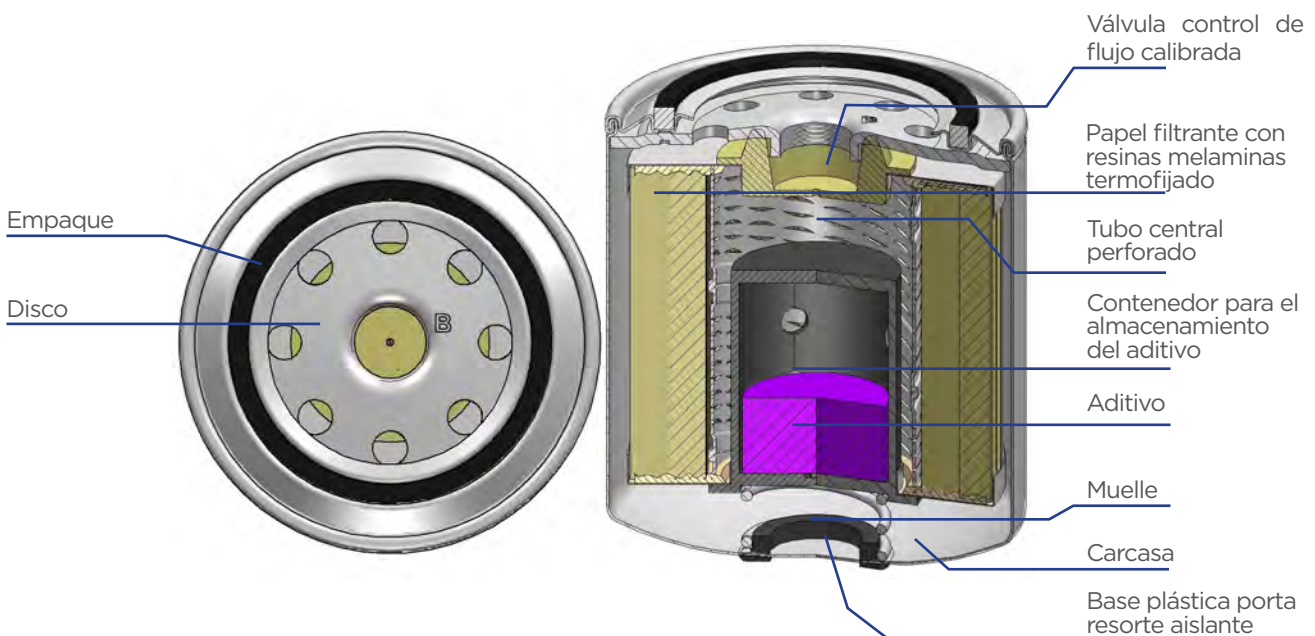



AW2010SP

**HD / PESADO
REFRIGERANTE
PRINCIPAL**

D. Exterior	93.7 mm
Altura	129 mm
Rosca	11/16x16 in
Tipo	Spin ON
Aditivo	SCA

APLICACIONES NISSAN/CHEVROLET
VOLVO/KENWORTH/DINA/DODGE
FORD/FREIGHTLINER/INTERNATIONAL



AW2016SP

**HD / PESADO
REFRIGERANTE
PRINCIPAL**

D. Exterior	93.7 mm
Altura	165 mm
Rosca	11/16x16 in
Tipo	Spin ON
Aditivo	SCA

APLICACIONES
CHEVROLET / FORD



AW2022SP

**HD / PESADO
REFRIGERANTE
PRINCIPAL**

D. Exterior	107.8 mm
Altura	143 mm
Rosca	1x16 in
Tipo	Spin ON
Aditivo	SCA

APLICACIONES
MACK



AW2127SP

**HD / PESADO
REFRIGERANTE
PRINCIPAL**

D. Exterior	93.7 mm
Altura	146 mm
Rosca	M36x2 mm
Tipo	Spin ON
Aditivo	SCA

APLICACIONES
FREIGHTLINER/INTERNATIONAL
KENWORTH



AW2237SP

**HD / PESADO
REFRIGERANTE
PRINCIPAL**

D. Exterior	93.7 mm
Altura	147 mm
Rosca	M16x1.5 mm
Tipo	Spin ON
Aditivo	SCA

APLICACIONES
VOLVO



AW475SP

**HD / PESADO
REFRIGERANTE
PRINCIPAL**

D. Exterior	93.7 mm
Altura	129 mm
Rosca	3/4x20 in
Tipo	Spin ON
Aditivo	SCA

APLICACIONES
MACK / RENAULT



AW5137SP

**HD / PESADO
REFRIGERANTE
PRINCIPAL**

D. Exterior	93.7 mm
Altura	103 mm
Rosca	11/16x16 in
Tipo	Spin ON
Aditivo	SCA

APLICACIONES:FORD/INTERNATIONAL
NISSAN/CHEVROLET/FREIGHTLINER
KENWORTH/MACK/VOLKSWAGEN



ES JUSTO
LO QUE NECESITAS



**SOLUCIONES EN FILTRACIÓN
PARA TRANSPORTE MEDIANO**

Encuétranos como
Filtros Partmo / f / @ / in / v /

partmo.com



CO-SC-CER896120

TIPS DE INSTALACIÓN

FILTROS DE AIRE CABINA O AIRE ACONDICIONADO

Un filtro al que poca importancia prestamos pero de gran incidencia para la salud de los pasajeros u ocupantes del vehículo, forma parte del sistema del aire acondicionado, el cual por norma todas las marcas fabricantes de vehículos incorporan independiente de la gama en que se clasifique, hoy en día aplicable no solamente en la línea automotriz sino también en equipos fuera de carretera.



Con el avance de la tecnología y un mercado cada vez más competitivo, accesorios que antes se consideraban de lujo en los automóviles, como el aire acondicionado, se han transformado en un artículo que puede marcar la diferencia a la hora de adquirir un vehículo.

Esta realidad queda a la vista con la llegada de autos de todas partes del mundo al mercado nacional, que aun con precios altos o bastante competitivos todos ofrecen como equipamiento de línea la importante opción del sistema de aire acondicionado.

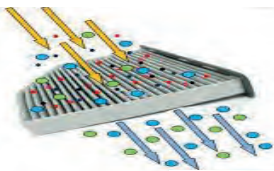

Para tener una idea, el aire que respiramos cuando estamos en la carretera o en las calles de la ciudad, contiene una gran cantidad de partículas como polvo, polen, alérgenos, humos, olores, smog y por supuesto los molestos gases de escape de los vehículos rodantes en la vía.

El aire en medio del tráfico contiene cinco veces más gases de escape, contaminantes y alérgenos que el aire que experimenta al estar al lado de la carretera. Además de eso, el flujo de aire a través de los conductos de aire de un vehículo puede llegar hasta los 540,000 litros / hora. La única barrera entre los pulmones sanos y la nube de contaminantes durante cada viaje es el filtro de aire Cabina.

El aire dentro del habitáculo se concentra entre 5 a 8 veces más que en el exterior, por lo que el ambiente al interior del auto tiene una alta posibilidad de ser un aire viciado y potencialmente dañino para la salud. Por esta razón y como todas las partes que componen la mecánica de un auto requieren de un mantenimiento constante para su correcto funcionamiento, el aire acondicionado demanda de una atención mayor ya que el filtro de aire que compone al sistema tiene una directa relación con el ambiente que se respira en el habitáculo.

Cuando se cambian regularmente, los filtros de cabina pueden ayudar a reducir la contaminación y el desgaste de los sistemas de calefacción, ventilación y aire acondicionado de su vehículo. Tener un filtro de cabina limpio a lo largo de la vida útil del vehículo mantendrá así una mayor eficiencia del vehículo y reducirá los costos generales de mantenimiento.

CÓMO FUNCIONA EL SISTEMA

El aire acondicionado, en términos simples, funciona de manera similar al sistema de una Nevera , aplicando el mismo principio de funcionamiento de ciclo frigorífico , captura aire desde el exterior para hacerlo circular por una serie de microtúneles que con la ayuda de gas refrigerante extraen el calor y entregan al habitáculo la placentera ventilación fría.

El punto es que el sistema por sí solo no es capaz de filtrar las partículas de polvo, polen y mucho menos los gases nocivos que pudieran ser capturados desde el exterior, por esta razón se utilizan filtros Biofuncionales que garantizan una máxima protección, varían entre tres a cuatro capas de grosor siendo estos por sus condiciones los más convenientes y saludables para asegurar el mejor y más limpio aire al interior del habitáculo.

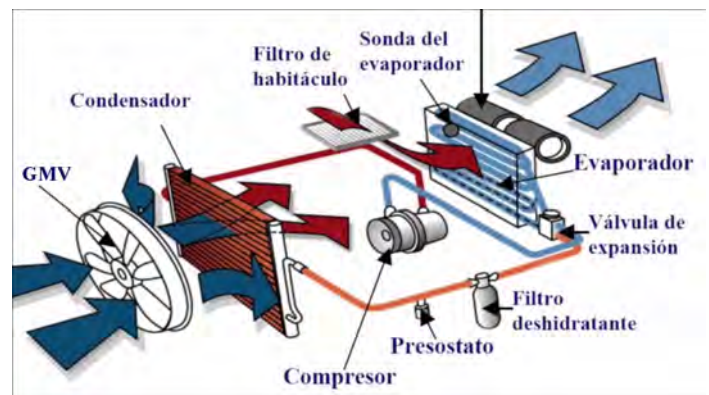

Cada capa tiene una función y en general se cuenta una superficie convencional que captura el polvo y otras moléculas de gran tamaño, luego se utiliza una lámina con productos germicidas que eliminan todo tipo de ácaros y bacterias microscópicas, finalmente una tercera capa la compone un filtro de carbono que se encarga acabar con todo tipo de mal olor y partículas que hayan logrado pasar el proceso.

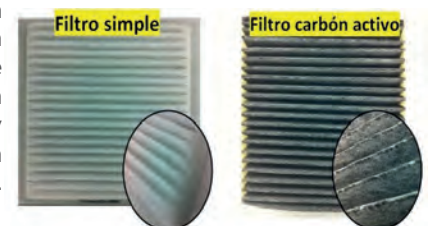

De esta manera el filtro se transforma en una especie de receptáculo que fácilmente puede albergar enfermedades u hongos debido a la humedad del sistema, ser un foco de alergias o fácilmente impedir el funcionamiento correcto del artefacto influyendo en el consumo de combustible y obviamente fallando en entregar el necesario aire frío.

Los alérgenos son la cuarta enfermedad crónica más importante del mundo según la Organización Mundial de la Salud; Cada vez más personas sufren de alergias, una reacción hipersensible de nuestro sistema inmunológico.

AIRE CABINA

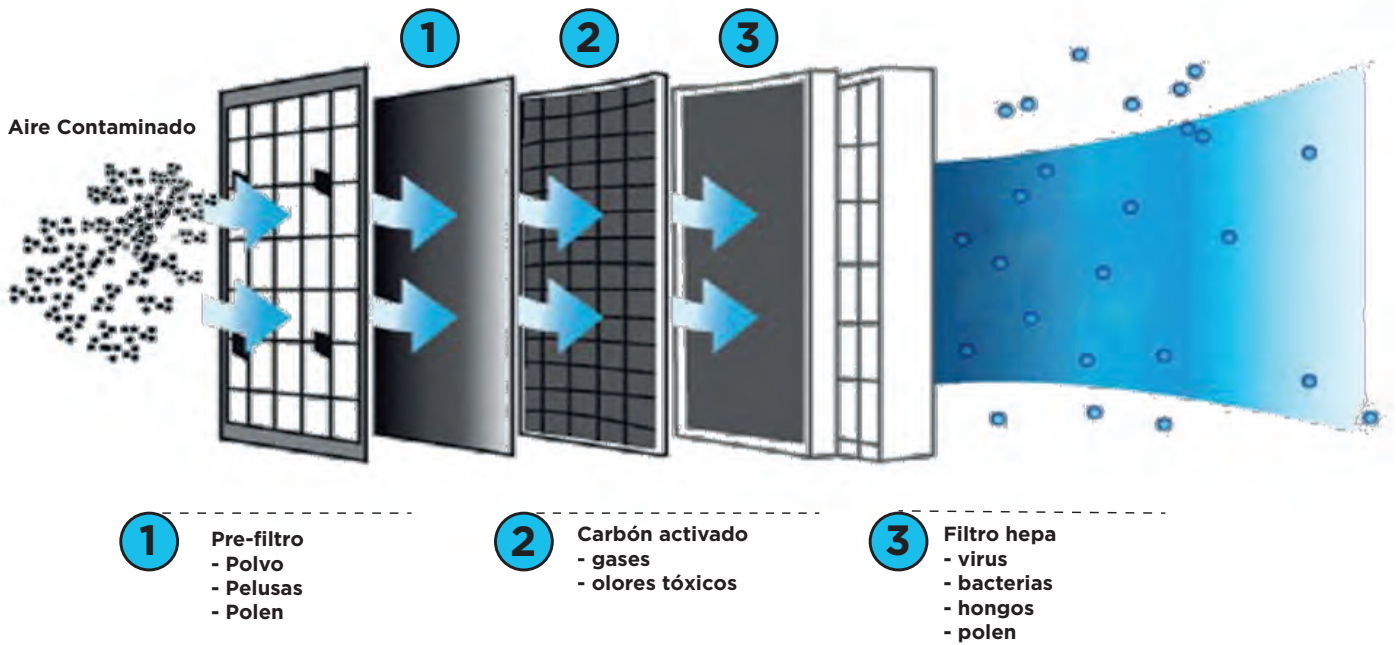

¿Cuándo debo reemplazar el filtro?

- Se recomienda cambiar el filtro de polen y/o partículas cada 12 mil kilómetros o cada año según ocurra primero.
- Si nota un olor desagradable o “mohoso” al subir al vehículo, es probable que el filtro albergue algún tipo de hongo o bacteria por lo que es tiempo de ser reemplazado.
- Es recomendado el reemplazo si al accionar el sistema comienza a sentir picazón en la nariz y molestias al respirar.
- Es altamente probable que el filtro de polen deba ser cambiado si nota un caudal de aire menor o deficiente al activar el aire acondicionado.



En consecuencia se debe ser consciente respecto a la seguridad y la salud de quienes comparten el vehículo realizando el cambio del filtro de partículas del sistema de aire acondicionado en las frecuencias o tiempos establecidos por cada fabricante, de esta

forma evitar molestias respiratorias, contar con un eficiente sistema de ventilación e incluso eliminar malos olores del vehículo para poder disfrutar de un placentero ambiente sano y limpio.

Instrucciones para Reemplazo Filtro Aire Cabina

Cambiar el filtro de cabina del vehículo es un trabajo fácil que la mayoría de las personas puede realizar. Siga las recomendaciones a continuación:



Paso Uno

Encuentre el filtro de cabina en su automóvil. La ubicación del filtro de aire para habitáculos puede variar de un vehículo a otro. En algunos automóviles se encuentra debajo del capó, mientras que en otros se encuentra detrás de la guantera o debajo del tablero. El manual del propietario del vehículo le indicará dónde se encuentra. También puede solicitarle a un mecánico u otro profesional de confianza que le muestre dónde se encuentra.

Paso Dos

Una vez que haya localizado la cubierta del filtro de aire de cabina, retire los sujetadores o tornillos y las tuercas que sujetan la cubierta. Quite la tapa y retire el filtro. Observe el filtro para ver si es necesario reemplazarlo o si servirá para algunos kilómetros más. Si está completamente saturado ha llegado el momento de reemplazarlo.

Paso Tres

Limpie el compartimento de la cubierta. Antes de instalar el filtro de aire para habitáculos nuevo, vale la pena limpiar el compartimento de la cubierta y el conducto de entrada de aire. Utilice una aspiradora para limpiar la suciedad y los desechos. Con un trapo limpie el interior de la cámara del filtro de aire para quitar la suciedad.

Paso Cuatro

Instala el nuevo filtro de aire para habitáculos. Simplemente ubique el filtro de aire para habitáculos en el mismo lugar donde se encontraba el filtro usado (NOTA: asegúrese de instalar el filtro en la dirección correcta de flujo de aire).

Paso Cinco

Vuelva a colocar la cubierta y los tornillos o sujetadores que retiró. Si tuvo que retirar la guantera o el tablero para acceder al filtro de aire para habitáculos, vuelva a colocarlos en su lugar revirtiendo los pasos que siguió para retirarlos.

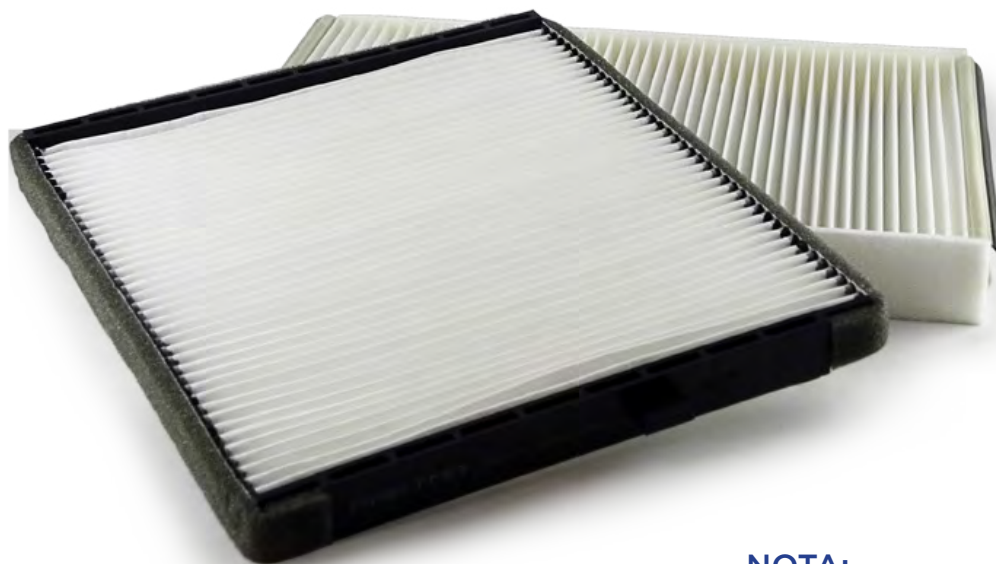

NOTA:

Se recomienda cambiar el filtro de cabina cada vez que se cambia de aceite.



AP31001
LD / LIVIANO
AIRE CABINA
PRINCIPAL

Altura	11 mm
Ancho 1	188 mm
Ancho 2	0 mm
Longitud 1	197 mm
Longitud 2	0 mm

APLICACIONES
CHEVROLET



AP31001
LDD / LIVIANO DIÉSEL
AIRE CABINA
PRINCIPAL

Altura	25 mm
Ancho 1	169 mm
Ancho 2	0 mm
Longitud 1	375 mm
Longitud 2	0 mm

APLICACIONES
MERCEDES BENZ



AP31002
LD / LIVIANO
AIRE CABINA
PRINCIPAL

Altura	25 mm
Ancho 1	225 mm
Ancho 2	0 mm
Longitud 1	208 mm
Longitud 2	0 mm

APLICACIONES
CHEVROLET



AP31006
LD / LIVIANO
AIRE CABINA
PRINCIPAL

Altura	42 mm
Ancho 1	168 mm
Ancho 2	0 mm
Longitud 1	200 mm
Longitud 2	0 mm

APLICACIONES
HYUNDAI



AP31012
LD / LIVIANO
AIRE CABINA
PRINCIPAL

Altura	22 mm
Ancho 1	109 mm
Ancho 2	0 mm
Longitud 1	219 mm
Longitud 2	0 mm

APLICACIONES
KIA / HYUNDAI



AP31015
LD / LIVIANO
AIRE CABINA
PRINCIPAL

Altura	30 mm
Ancho 1	215 mm
Ancho 2	0 mm
Longitud 1	234 mm
Longitud 2	0 mm

APLICACIONES
FORD / MAZDA



AP31017
LD / LIVIANO
AIRE CABINA
PRINCIPAL

Altura	20 mm
Ancho 1	105 mm
Ancho 2	0 mm
Longitud 1	282 mm
Longitud 2	0 mm

APLICACIONES
SSANGYONG



AP31026
AIRE CABINA
PRINCIPAL

Altura	20 mm
Ancho 1	202 mm
Ancho 2	0 mm
Longitud 1	270 mm
Longitud 2	0 mm

APLICACIONES
CHEVROLET



AP31030
LDD / LIVIANO DIÉSEL
AIRE CABINA
PRINCIPAL

Altura	20 mm
Ancho 1	210 mm
Ancho 2	0 mm
Longitud 1	220 mm
Longitud 2	0 mm

APLICACIONES
CHEVROLET / GREAT WALL



AP31033
LD / LIVIANO
AIRE CABINA
PRINCIPAL

Altura	25 mm
Ancho 1	195 mm
Ancho 2	0 mm
Longitud 1	217 mm
Longitud 2	0 mm

APLICACIONES
DODGE / JEEP



AP31035
LD / LIVIANO
AIRE CABINA
PRINCIPAL

Altura	35 mm
Ancho 1	184 mm
Ancho 2	0 mm
Longitud 1	239 mm
Longitud 2	0 mm

APLICACIONES
FORD



AP31036
HD / PESADO
AIRE CABINA
PRINCIPAL

Altura	23 mm
Ancho 1	220 mm
Ancho 2	0 mm
Longitud 1	210 mm
Longitud 2	0 mm

APLICACIONES
FREIGHTLINER



AP31037
HD / PESADO
AIRE CABINA
PRINCIPAL

Altura	25 mm
Ancho 1	267 mm
Ancho 2	0 mm
Longitud 1	220 mm
Longitud 2	0 mm

APLICACIONES
FREIGHTLINER



AP31042
LD / LIVIANO
AIRE CABINA
PRINCIPAL

Altura	20 mm
Ancho 1	197 mm
Ancho 2	0 mm
Longitud 1	238 mm
Longitud 2	0 mm

APLICACIONES
HYUNDAI



AP31043
LD / LIVIANO
AIRE CABINA
PRINCIPAL

Altura	20 mm
Ancho 1	197 mm
Ancho 2	0 mm
Longitud 1	238 mm
Longitud 2	0 mm

APLICACIONES
HYUNDAI



AP31054
LD / LIVIANO
AIRE CABINA
PRINCIPAL

Altura	17 mm
Ancho 1	197 mm
Ancho 2	0 mm
Longitud 1	220 mm
Longitud 2	0 mm

APLICACIONES
KIA



AP31055
LD / LIVIANO
AIRE CABINA
PRINCIPAL

Altura	12 mm
Ancho 1	180 mm
Ancho 2	0 mm
Longitud 1	186.3 mm
Longitud 2	0 mm

APLICACIONES
KIA



AP31060
LDD / LIVIANO DIÉSEL
AIRE CABINA
PRINCIPAL

Altura	24 mm
Ancho 1	103 mm
Ancho 2	0 mm
Longitud 1	255 mm
Longitud 2	0 mm

APLICACIONES
NISSAN



AP31063
LD / LIVIANO
AIRE CABINA
PRINCIPAL

Altura	30 mm
Ancho 1	160 mm
Ancho 2	0 mm
Longitud 1	230 mm
Longitud 2	0 mm

APLICACIONES
RENAULT



AP31064
LD / LIVIANO
AIRE CABINA
PRINCIPAL

Altura	18.5 mm
Ancho 1	194 mm
Ancho 2	0 mm
Longitud 1	206 mm
Longitud 2	0 mm

APLICACIONES
MERCEDES BENZ



AP31065
LD / LIVIANO
AIRE CABINA
PRINCIPAL

Altura	20 mm
Ancho 1	187 mm
Ancho 2	0 mm
Longitud 1	247 mm
Longitud 2	0 mm

APLICACIONES
RENAULT



AP31068
LD / LIVIANO
AIRE CABINA
PRINCIPAL

Altura	17 mm
Ancho 1	193 mm
Ancho 2	0 mm
Longitud 1	214 mm
Longitud 2	0 mm

APLICACIONES
RENAULT



AP31070
LD / LIVIANO
AIRE CABINA
PRINCIPAL

Altura	31 mm
Ancho 1	192 mm
Ancho 2	0 mm
Longitud 1	213 mm
Longitud 2	0 mm

APLICACIONES
TOYOTA



AP31071
LDD / LIVIANO DIÉSEL
AIRE CABINA
PRINCIPAL

Altura	29 mm
Ancho 1	195 mm
Ancho 2	0 mm
Longitud 1	214 mm
Longitud 2	0 mm

APLICACIONES
TOYOTA



AP31081

LD / LIVIANO
AIRE CABINA
PRINCIPAL

Altura	28 mm
Ancho 1	195 mm
Ancho 2	0 mm
Longitud 1	212 mm
Longitud 2	0 mm

APLICACIONES
TOYOTA / SUBARU



AP31084

LDD / LIVIANO DIÉSEL
AIRE CABINA
PRINCIPAL

Altura	50 mm
Ancho 1	235 mm
Ancho 2	0 mm
Longitud 1	350 mm
Longitud 2	0 mm

APLICACIONES
MERCEDES BENZ / VOLKSWAGEN



AP31088

LD / LIVIANO
AIRE CABINA
PRINCIPAL

Altura	35.5 mm
Ancho 1	179.5 mm
Ancho 2	0 mm
Longitud 1	238 mm
Longitud 2	0 mm

APLICACIONES
NISSAN



AP31090

LD / LIVIANO
AIRE CABINA
PRINCIPAL

Altura	42.6 mm
Ancho 1	190 mm
Ancho 2	0 mm
Longitud 1	223.6 mm
Longitud 2	0 mm

APLICACIONES
NISSAN / RENAULT



AP31096

LD / LIVIANO
AIRE CABINA
PRINCIPAL

Altura	19 mm
Ancho 1	205 mm
Ancho 2	0 mm
Longitud 1	228 mm
Longitud 2	0 mm

APLICACIONES
MAZDA

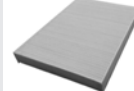

AP31097

LD / LIVIANO
AIRE CABINA
PRINCIPAL

Altura	30 mm
Ancho 1	180 mm
Ancho 2	0 mm
Longitud 1	250 mm
Longitud 2	0 mm

APLICACIONES
NISSAN / RENAULT



AP31101

LDD / LIVIANO DIÉSEL
AIRE CABINA
PRINCIPAL

Altura	30 mm
Ancho 1	182 mm
Ancho 2	0 mm
Longitud 1	340 mm
Longitud 2	0 mm

APLICACIONES
RENAULT



AP31102

LDD / LIVIANO DIÉSEL
AIRE CABINA
PRINCIPAL

Altura	20 mm
Ancho 1	215 mm
Ancho 2	0 mm
Longitud 1	238 mm
Longitud 2	0 mm

APLICACIONES
RENAULT



AP31123

LDD / LIVIANO DIÉSEL
AIRE CABINA
PRINCIPAL

Altura	32 mm
Ancho 1	201 mm
Ancho 2	0 mm
Longitud 1	217 mm
Longitud 2	0 mm

APLICACIONES
NISSAN



AP31136

LD / LIVIANO
AIRE CABINA
PRINCIPAL

Altura	35 mm
Ancho 1	195 mm
Ancho 2	0 mm
Longitud 1	261 mm
Longitud 2	0 mm

APLICACIONES
RENAULT



AP31138

LDD / LIVIANO DIÉSEL
AIRE CABINA
PRINCIPAL

Altura	30 mm
Ancho 1	187 mm
Ancho 2	0 mm
Longitud 1	261 mm
Longitud 2	0 mm

APLICACIONES
TOYOTA



AP31631

LDD / LIVIANO DIÉSEL
AIRE CABINA
PRINCIPAL

Altura	30 mm
Ancho 1	219 mm
Ancho 2	0 mm
Longitud 1	278 mm
Longitud 2	0 mm

APLICACIONES
VOLKSWAGEN



AP31739

LD / LIVIANO
AIRE CABINA
PRINCIPAL

Altura	17 mm
Ancho 1	200 mm
Ancho 2	0 mm
Longitud 1	226 mm
Longitud 2	0 mm

APLICACIONES
HYUNDAI / KIA



AP31743

LD / LIVIANO
AIRE CABINA
PRINCIPAL

Altura	12 mm
Ancho 1	182 mm
Ancho 2	0 mm
Longitud 1	183 mm
Longitud 2	0 mm

APLICACIONES
HYUNDAI / KIA



AP33893

LD / LIVIANO
AIRE CABINA
PRINCIPAL

Altura	35 mm
Ancho 1	194 mm
Ancho 2	0 mm
Longitud 1	272 mm
Longitud 2	0 mm

APLICACIONES
MERCEDES BENZ



AP39649

LD / LIVIANO
AIRE CABINA
PRINCIPAL

Altura	19 mm
Ancho 1	206 mm
Ancho 2	0 mm
Longitud 1	238 mm
Longitud 2	0 mm

APLICACIONES
CHEVROLET



AP40878

LD / LIVIANO
AIRE CABINA
PRINCIPAL

Altura	26 mm
Ancho 1	208 mm
Ancho 2	0 mm
Longitud 1	272 mm
Longitud 2	0 mm

APLICACIONES
CHEVROLET



AP43042

HD / PESADO
AIRE CABINA
PRINCIPAL

Altura	24 mm
Ancho 1	181 mm
Ancho 2	0 mm
Longitud 1	321 mm
Longitud 2	0 mm

APLICACIONES
INTERNATIONAL



AP43100

LD / LIVIANO
AIRE CABINA
PRINCIPAL

Altura	28 mm
Ancho 1	198 mm
Ancho 2	0 mm
Longitud 1	228 mm
Longitud 2	0 mm

APLICACIONES
NISSAN



AP71191

LD / LIVIANO
AIRE CABINA
PRINCIPAL

Altura	35 mm
Ancho 1	202 mm
Ancho 2	0 mm
Longitud 1	240 mm
Longitud 2	0 mm

APLICACIONES
CHEVROLET

AIRE CABINA



ES JUSTO
LO QUE NECESITAS



**SOLUCIONES EN FILTRACIÓN
PARA TRANSPORTE MEDIANO**

Encuétranos como
Filtros Partmo / f / @ / in / v /

partmo.com



CO-SC-CER896120



A354
HD / PESADO
ACEITE HIDRAULICO
PRINCIPAL

D. Exterior	93.7 mm
Rosca	1-1/8x16 in
Altura	136 mm
V. de presión	8 a 11 psi
V. antidrenaje	NO
Sello	NO

APLICACIONES
FORD



A83910
HD / PESADO
ACEITE HIDRAULICO
PRINCIPAL

D. Exterior	93.7 mm
Rosca	1x12 in
Altura	136 mm
V. de presión	0 psi
V. antidrenaje	NO
Sello	NO

APLICACIONES
FORD



A915
OTROS
SEP. AGUA COMBUSTIBLE
PRINCIPAL

D. Exterior	107.8 mm
Altura	214 mm
Rosca	1x12 in
D. Montura	0 mm
D. Empaque	NO
-	-

APLICACIONES
COMBUSTIBLE SURTIDORES.



A70010
OTROS
COMBUSTIBLE
PRINCIPAL

D. Exterior	93.7 mm
Altura	129 mm
Rosca	1x12 in
D. Montura	0 mm
D. Empaque	NO
-	-

APLICACIONES
COMBUSTIBLE SURTIDORES.



A70015SP
OTROS
COMBUSTIBLE
PRINCIPAL

D. Exterior	93.7 mm
Altura	131 mm
Rosca	1-1/2"x16
D. Montura	0 mm
D. Empaque	NO
-	-

APLICACIONES
COMBUSTIBLE SURTIDORES.



A70016SP
OTROS
COMBUSTIBLE
PRINCIPAL

D. Exterior	93.7 mm
Altura	131 mm
Rosca	1-1/2x16 in
D. Montura	0 mm
D. Empaque	NO
-	-

APLICACIONES
COMBUSTIBLE SURTIDORES.



AA5374
HD / PESADO
SECADOR DE FRENO
PRINCIPAL

D. Exterior	139 mm
Rosca	M 39 x 1.5
Altura	166 mm
D. Montura	-
Tipo	-
Sello	-

APLICACIONES
FOTON/INTERNATIONAL/KENWORTH/IVECO
VOLVO/FREIGHTLINER/VOLKSWAGEN



PP246
OTROS
COMBUSTIBLE
PRINCIPAL

D. Exterior	78 mm
Altura	125 mm
Rosca	1-1/8x12
Sello	NO
Tipo	Cartucho
Subtipo	Vaso Visor

APLICACIONES
COMBUSTIBLE SURTIDORES.

OTROS



ES JUSTO
LO QUE NECESITAS



**SOLUCIONES EN FILTRACIÓN
PARA TRANSPORTE MEDIANO**

Encuétranos como
Filtros Partmo / f / @ / in / v /

partmo.com



CO-SC-CER896120

KIT A2700SP



AP2877S
AIRE PRINCIPAL

A2700SP
ACEITE

A4053SP (2)
COMBUSTIBLE PRINCIPAL

A4054SP
COMBUSTIBLE SECUNDARIO

MEDIANO



APLICACIONES
CHEVROLET / ISUZU NPR / NQR MOD. 2000-2011, ISUZU 4HK1-TCN / 4HG1T

KIT A7041SP



AP2877S
AIRE PRINCIPAL

A7041SP
ACEITE

A4053SP (2)
COMBUSTIBLE PRINCIPAL

A4054SP
COMBUSTIBLE SECUNDARIO

MEDIANO



APLICACIONES
CHEVROLET / ISUZU NPR / NQR MOD. 2000-2011, ISUZU 4HK1-TCN / 4HG1T

KIT A7643SP



AP14210
AIRE PRINCIPAL

AP14220
AIRE SEGURIDAD

A205SP
ACEITE

PP24811
COMBUSTIBLE PRINCIPAL

PP28970
COMBUSTIBLE SECUNDARIO

MEDIANO



APLICACIONES
CHEVROLET / ISUZU FRR FORWARD MOD. SUP A 2012, FTR 6HK1 TCN

KIT A7645SP



AP2877S
AIRE PRINCIPAL

PP88580
ACEITE

PP28970
COMBUSTIBLE SECUNDARIO

ASR90TSP
SEP. AGUA COMBUSTIBLE

MEDIANO



APLICACIONES
CHEVROLET / ISUZU NKR REWARD SERIE II-III MOD.SUP A 2011, NRR MOD.2011 4JU1 TC

KIT A7647SP



AP78090
AIRE PRINCIPAL

A4048SP
ACEITE

PP1112
SEP. AGUA COMBUSTIBLE

PP78091SP
SEP. AGUA COMBUSTIBLE

MEDIANO



APLICACIONES
HINO DUTRO 300 MAX, EURO IV / V, N04CVC 4.0LTS

KIT A7650SP



AP2877S
AIRE PRINCIPAL

A2700SP
ACEITE

A941SP
COMBUSTIBLE PRIMARIO

A4054SP
COMBUSTIBLE SECUNDARIO

MEDIANO



APLICACIONES
CHEVROLET / ISUZU NPR MOD. 2007-2011 M 4BD2T DIESEL | NQR MOD. 2007-2011 4HG1T

KIT A7651SP



AP2877S
AIRE PRINCIPAL

A7041SP
ACEITE

A941SP
COMBUSTIBLE PRIMARIO

A4054SP
COMBUSTIBLE SECUNDARIO

MEDIANO



APLICACIONES
CHEVROLET / ISUZU NPR MOD. 2007-2011 M 4BD2T DIESEL | NQR MOD. 2007-2011 4HG1T

KIT A7652SP



AP2712
AIRE PRINCIPAL

A4271SP
ACEITE

A4053SP(2)
COMBUSTIBLE PRIMARIO

MEDIANO



APLICACIONES
CHEVROLET / ISUZU NKR/NHR MOD. 2005-2011 | NKR III MOD. 2010> 4JB1-TC

KIT A7654SP



AP17871
AIRE PRINCIPAL

AP17871SY
AIRE SEGURIDAD

A7105SP
ACEITE

PP11682SP
COMBUSTIBLE PRINCIPAL

PM1940
SEP. AGUA COMBUSTIBLE

MEDIANO



APLICACIONES
HINO FC9J, EURO III, MOD. SUP A 2013, E-7 350 ETCH, J05E TC

KIT A7655SP



AP2205
AIRE PRINCIPAL

A427SP
ACEITE

A243004SP
COMBUSTIBLE SECUNDARIO

A43SP
SEP. AGUA COMBUSTIBLE

MEDIANO



APLICACIONES
JAC 1063, MOD. SUP A 2009 CUMM. 6BT 5,9LT

KIT A7656SP



AP2877S
AIRE PRINCIPAL

AP2877SY
AIRE SEGURIDAD

A7898SP
ACEITE

PP5706
COMBUSTIBLE PRINCIPAL

PM1940
SEP. AGUA COMBUSTIBLE

MEDIANO



APLICACIONES
JAC 1083/2013>/CUMM. ISF 3.8

KIT A7657SP



AP2877S
AIRE PRINCIPAL

A2700SP
ACEITE

PP28970
COMBUSTIBLE SECUNDARIO

ASR90TSP
SEP. AGUA COMBUSTIBLE

MEDIANO



APLICACIONES
CHEVROLET / ISUZU NPR / NQR REWARD
MOD.SUP A 2012, ISUZU 4HK1-TCN

KIT A7658SP



AP2877S
AIRE PRINCIPAL

A7041SP
ACEITE

PP28970
COMBUSTIBLE SECUNDARIO

ASR90TSP
SEP. AGUA COMBUSTIBLE

MEDIANO



APLICACIONES
CHEVROLET / ISUZU NPR/NQR REWARD
MOD. 2012>

KIT A7659SP



AP1325
AIRE PRINCIPAL

AP1330E
AIRE SEGURIDAD

A7105SP
ACEITE

A034L
COMBUSTIBLE SECUNDARIO

AS1441SP
SEP. AGUA COMBUSTIBLE

MEDIANO



APLICACIONES
HINO FG1J/ FM1J / GD1J / FC/GH SERIE 500
2005> J08C -TW / J08C TT TURBO

KIT A7660SP



AP78020
AIRE PRINCIPAL

A4048SP
ACEITE

PP1112
SEP. AGUA COMBUSTIBLE

PM1940
SEP. AGUA COMBUSTIBLE

MEDIANO



APLICACIONES
HINO DUTRO MAX / CITY 300 / 4.000CC
MOD.SUP A 2011 , 616 N04C-TT 148HP

KIT A7661SP



AP2251
AIRE PRINCIPAL

A7898SP
ACEITE

PP5706
COMBUSTIBLE SECUNDARIO

ASR90TSP
SEP. AGUA COMBUSTIBLE

MEDIANO



APLICACIONES
FOTON AUMARK BJ1681 / 6.0T, 3.8LT / MOD.SUP A 2015 , CUMM ISF 3.8LT

KIT A7665SP



AP17871
AIRE PRINCIPAL

AP17871SY
AIRE SEGURIDAD

A7105SP
ACEITE

PP04041
COMBUSTIBLE SECUNDARIO

PM1940
SEP. AGUA COMBUSTIBLE

MEDIANO



APLICACIONES
HINO FC9J / MOD. SUP A 2018, JO5E US 177HP EURO V

KIT A7666SP



AP14210
AIRE PRINCIPAL

AP14220
AIRE SEGURIDAD

A7041SP
ACEITE

PP24811
COMBUSTIBLE PRIMARIO

PP28970
COMBUSTIBLE SECUNDARIO

MEDIANO



APLICACIONES
CHEVROLET / ISUZU FRR FORWARD 2012-2022, ISUZU-4HK1-TCS 5.2 lts

KIT A7667SP



AP2877S
AIRE PRINCIPAL

A4271SP
ACEITE

PP7355 (2)
COMBUSTIBLE

MEDIANO



APLICACIONES
CHEVROLET / ISUZU NHR REWARD MOD. 2016-2022, ISUZU 4JH1-TC, EURO IV

KIT A7668SP



AP2877S
AIRE PRINCIPAL

A4271SP
ACEITE

AK570SP
COMBUSTIBLE

MEDIANO



APLICACIONES
CHEVROLET / ISUZU NHR REWARD MOD 2012- 2015, ISUZU 4JB1-TC / ISUZU NMR

KIT AP1325



AP1325 AIRE PRINCIPAL
AP1330E AIRE SEGURIDAD



APLICACIONES
HINO 500 FG81, FM81, GH81
MOD 2015> J08E-UB 7.6Lts
EURO IV

KIT AP2688



AP2688 AIRE PRINCIPAL
AP2621 AIRE SEGURIDAD



APLICACIONES
HINO 160 GD, GH 2002-2004
Motor HINO 160

KIT AP17871



AP17871 AIRE PRINCIPAL
AP17871SY AIRE SEGURIDAD



APLICACIONES
HINO CAMIÓN FC9J EXPRESS
MOD.2013 MOTOR E-7 350
E-TECH

KIT AP14210



AP14210 AIRE PRINCIPAL
AP14220 AIRE SEGURIDAD



APLICACIONES
CHEVROLET FRR CARGA
2012-2014 ISUZU 4HK1-TCS

KIT AP17845



AP17845 AIRE PRINCIPAL
AP17846 AIRE SEGURIDAD



APLICACIONES
HINO SERIE 700 FS1E 2007
HINO E13C 400HP

KIT AP80006



AP80006 AIRE PRINCIPAL
AP80006SY AIRE SEGURIDAD



APLICACIONES
MITSUBISHI FUSO FA 9.0 / FI
10.4 2017> 4D37 - 125



ES JUSTO
LO QUE NECESITAS



GUÍAS DE FILTRACIÓN - PESADO



CO-SC-CER896120

MARCA	LÍNEA	AÑO	MOTOR	AIRE	ACEITE	COMBUSTIBLE	OTROS
CHEVROLET	CHEVROLET C70 TURBO DIESE	N/D	PINCHER TURBO	AP2577	A11 / PMX750R	A96SP / A97SP	
CHEVROLET	B-70 DIESEL BUS	2004-2008	CAT 3126E	AP2863	A67SP	A1212SP / ASV1212SP	
CHEVROLET	BRIG. DOBLE TROQUE CAREZAPATO	1992-1996	CUMM N14	AP3518 / AP3518SY	A3000SP	A1212SP / ASV1212SP	AW2010SP
CHEVROLET	BRIGADIER DETROIT	1992	DETROIT		A116CSP	A96SP / A97SP	AW2010SP
CHEVROLET	BRIGADIER 151	N/D	CUMM NTC-290	AP95600906	A116SP / A777SP	A23SP / A23ASP / A1212SP / ASV1212SP	AW2016SP
CHEVROLET	BRIGADIER CAMION CAREZAPATO	1990-2000	CUMM	AP524344	A3000SP	A1212SP / ASV1212SP	AW2010SP
CHEVROLET	BRIGADIER CAREZAPATO	1990-1995	CUMM N14	AP524344	A3000SP	A23SP / A23ASP	
CHEVROLET	BRIGADIER CAREPANELA	1980-1990	GENERAL	AP95600906	A116SP / PMX750R / A777SP	A23SP / A23ASP	
CHEVROLET	BRIGADIER DETROIT	1992	DETROIT DIESEL	AP2704	A116CSP	A96SP / A97SP	
CHEVROLET	BRIGADIER TANDEM 221	N/D	CUMM NTC-290	AP524344	A3000SP	A23SP / A23ASP	AW2016SP
CHEVROLET	CAMIONES SERIE F (FSR, FTR, FVR)	2006-2007	ISUZU 6HE1-TCS	AP5021 / AP51250	A205SP	A7602 / PM1940 / A1CSP	
CHEVROLET	CHEVROLET B-60 Y C-70	N/D	PINCHER DIESEL	AP2576	A11 / PMX750R	A96C / A97C	
CHEVROLET	CHEVROLET B-60 Y C-70; GMC	1973	GASOLINA	AP121	A84SP		
CHEVROLET	CHEVROLET BUSES Y CAMIONES 196	1962	V-8 /Diesel		PM197		
CHEVROLET	CHEVROLET CHR580 MOTOR ISUZU.	N/D	ISUZU 580	AP110558	PM9885132652 / PMX1878100501	PM1878100270 / PM1878100271	
CHEVROLET	CHR-580 TURBO	N/D	ISUZU 580	AP110558	PM9885132652 / PMX1878100501	PM1878100271 / PM1878100270	
CHEVROLET	CHR-7.2 BUSES	2004-2008	ISUZU 6HE1-TC	AP5021 / AP51250	PM7572 / PM1320	A7602 / PM1940 / A1CSP	
CHEVROLET	CYZ EURO II	2014	6WF1-TCC	AP5213 / AP5213SY	PM1650 / PM2240	PM9760	
CHEVROLET	FRR CARGA	2012-2014	ISUZU 4HK1-TCS	AP14210 / AP14220	A7041SP	PP28970 / PP24811	
CHEVROLET	FRR-FORWARD	2012 -2022	ISUZU-4HK1-TCS 5.2 lts	AP14210 / AP14220	A7041SP	PP28970 / PP24811	
CHEVROLET	FSR CARGA	2006-2011	ISUZU 6HE1-TCS	AP5021 / AP51250	A205SP	A7602 / PM1940	
CHEVROLET	FSR CARGA	2006-2011	ISUZU 7,2 250HP	AP5021 / AP51250	A205SP	A7602 / PM1940 / A1CSP	
CHEVROLET	FSR CARGA	2006-2011	ISUZU 6HE1-TCS	AP3548	A205SP	PP28970 / PP24811	
CHEVROLET	FTR CAMION 205HP	2007-2011	ISUZU 7,2LT	AP5021 / AP51250	A205SP	A7602 / PM1940 / A1CSP	
CHEVROLET	FTR FORDWARD EURO IV CARGA	2012-2022	6HK1-TCN	AP14210 / AP14220	A205SP	PP28970 / PP24811	
CHEVROLET	FTR FORWARD CARGA	2013-2015	ISUZU 7,8 6HK1-TC	AP14210 / AP14220	A205SP	PP28970 / PP24811	
CHEVROLET	FTR FORWARD 7.800cc	2011>	ISUZU 6HK1 -TCN	AP14210 / AP14220	A205SP	PP28970 / PP24811	
CHEVROLET	FTR,FVR,FSR	2007-2011	ISUZU 7,2LT 250HP	AP5021 / AP51250	A205SP	A7602 / PM1940 / A1CSP	
CHEVROLET	FVR FORWARD EURO IV	2013-2021	6HK1-TCN	AP3548	A205SP	PP28970 / PP24811	
CHEVROLET	FVR y FVZ MINIMULA, VOLQUETA	2013-2021	ISUZU 6HK1-TCN	AP3548	A205SP	PP28970 / PP24811	
CHEVROLET	ISUZU 660	1990	CH660 ; CHR600	AP127312	PM9885132652	PM1878100270 / PM1878100271	
CHEVROLET	KODIAK DIESEL 209, 211	1996-1998	MOTOR 211-	AP2863 / AP3501	A67SP / PMX750R	A1R0751SP / AS3202SP / A5813SP	

MARCA	LÍNEA	AÑO	MOTOR	AIRE	ACEITE	COMBUSTIBLE	OTROS
CHEVROLET	KODIAK DIESEL 157, 211, 241	2004-2007	CAT 3116 Y 3126E	AP2863 / AP3501	A67SP / PMX750R	A1R0751SP / AS3202SP / A5813SP	
CHEVROLET	KODIAK TANDEM 06 / 07	2006-2007	CAT 3126 ELEC	AP2863 / AP3501	A67SP / PMX750R	A1R0751SP / A1212SP	
CHEVROLET	LV 452 BUS, CAMION EURO IV	2015- 2022	6WG1TC ISUZU	AP5213 / AP5213SY	PM1650 / PM2240	PM9760 / PP24811 (2)	
CHEVROLET	LV-150 BUS	2003-2012	ISZ 6WA1TC	AP5203 / AP5217	PM1650 / PM2240	PM9760 / PM1940	
CHEVROLET	MOTORES CUMMINS 160-180	1980	MOTORES CUMMINS	AP2741			
CHEVROLET	SUPER BRIG 185	N/D	CUMM	AP524344	A116SP / A777SP	A23SP / A23ASP	AW2016SP
CHEVROLET	SUPER BRIG 229	N/D	DDA 6V-92T	AP95600906	A116SP / PMX750R	A96SP / A97SP	AW2016SP
CHEVROLET	SUPER BRIG 229	N/D	NTC-290	AP524344	A116SP / A777SP	A23SP / A23ASP	AW2016SP
CHEVROLET	SUPER BRIG. 250-290	1987-1993	CUMM	AP95600906	A116SP / A777SP	A23SP / A23ASP	AW2010SP
CHEVROLET	SUPER BRIGADIER	N/D	CUMM 240	AP3518 / AP3518SY	A205SP	A23SP / A23ASP	AW5137SP
CHEVROLET	SUPER BRIGADIER DIESEL	N/D	DET (6V-92T) DIES	AP95600906	A116SP / PMX750R	A96SP / A97SP	AW2010SP
DAEWOO	VOLQUETA NOVUS	2007-2010	CUMM	AP2036 / AP4036	A116SP	A1259SP	
DAEWOO	VOLQUETA NOVUS	2007-2010	K4D DOOSAN 12 L	AP2036 / AP4036	A116SP	A1212SP	
DAEWOO	VOLQUETA NOVUS	2007-2010	DOOSAN DL08K 320 HP EURO V	AP2036 / AP4036	A116SP	A1259SP	
DAEWOO	VOLQUETA NOVUS	2007-2010	DOOSAN DV11K 390 Y 420 HP EURO V	AP127312 / AP127313	A339SP		
DINA	4700	1997	IHC 466	AP182028	A48SP	A588SP / A1259SP	AW2010SP
DINA	7400 -310	1997	CUMM L10	AP182028	A3000SP	A1212SP	AW2010SP
DINA	D 500 NAVISTAR	N/D	DT4 408	AP182028	A408SP	A588SP / A1259SP	AW2010SP
DODGE	BUSES Y CAMIONES FORD, DODGE,	N/D	CUMMINS LF-613		PM343 / PM248		
DODGE	Dodge /D-500, D-600, D-700	N/D	MOTOR 361		PM192		
DODGE	RAM 6500 DIESEL	2000	6500 CUMM	AP2520H	A339SP	A243004SP / P3461	
DODGE	RAM 6500 DIESEL MEXICO	N/D	6.5 CUMM	AP2520H	A427SP	A243004SP / A43SP	AW2010SP
DODGE	Camiones D-600	1992-1995	RAM 6500 Diesel			A43PSP	
DONG FENG	JINGANG 10,7 TON	2011>	CUMMINS EQU 180-20		A48SP	A243004SP / A243004DSP	
FAW	CA4250 JH6	2019>	WEICHAI WP13 430 HP GNV EURO V		A7174SP		
FAW	AGCA 1183	2021	WEICHAI WP7N G240 E51 EURO V				
FAW	AGCA1250	2021	WEICHAI WP12NV400E50 EURO V				
FAW	AGCA3250	2021	WEICHAI WP12NV430E52 EURO V				
FAW	CA3310	2021	WEICHAI WP10H375E50				
FAW	CA4250 JH6	2019>	WEICHAI WP13 430 HP GNV EURO 5		A7174SP		
FAW	CA5083	2006	CA4DF2-13 TAA 4,8 LTS 130 HP	AP41702	A54SP	AS103SP / A243004DSP	
FORD	8000 ELECTRONICO CAMION	2001	CUMM ISB	AP2863	A354	A1CSP	
FORD	9000 AEROMAX	1994	CUMM N14	AP2632	A3000SP	A1212SP / ASV1212SP	
FORD	AEROMAX 9000 CAMION	1994	CUMM M11	AP3518 / AP3518SY	A3000SP	A1212SP / ASV1212SP	AW2010SP

MARCA	LÍNEA	AÑO	MOTOR	AIRE	ACEITE	COMBUSTIBLE	OTROS
FORD	C7000, F7000 , LN7000	1985	FORD		A349SP	A1226LSP	
FORD	CARGO 1019	2019>	CUMM. ISB 4,5 EURO V	AP17308	A7898SP	A7813SP / AS1249SP	
FORD	CARGO 1721	2003-2010	CUMM. 8,3 LTS	AP5627 / AP5628	A9009SP	A243004SP / AS1249SP	AW2010SP
FORD	EQUIPOS FORD. TRACTORES TW5, T	N/D	TW5, TW15, TW25 /DIESEL		A343		
FORD	CARGO 3129	2017-2019	Cummins ISB 6.7, 286HP, EURO V	AP5627 / AP5628	A7898SP	A7813SP	
FORD	F7000, F8000	1985	CUMM. 170 5,9L	AP2863	A339SP	A243004SP / A43SP	AW2010SP
FORD	F8000 CAMION	1997	CUMM.	AP2863	A349SP	A1212SP / A243004DSP	
FORD	FORD 600	1985	FORD V-8		PM174		
FORD	FORD 9000 AEROMAX	1994	DETROIT	AP2425	PM197	A96SP / A97SP	
FORD	FORD CAMIONES CON MOTOR CATERP	1980	V8-522 Y 573, V8-636 (3208)		A9N5570SP	A1P2299 / A23L39SP	AW2010SP
FOTON	AUMAN 330 HP	2009	330HP WD615, 44DTA	AP2216	A840SP	A7813SP	
FOTON	AUMAN BJ 1133 I210 CTX	2011	CUMM. ISD 210 30	AP2291	A7898SP	A7813SP / ASR90TDS	
FOTON	AUMAN BJ 1133 I210 CTX	2011	CUMM. ISD 210 30		A7898SP		
FOTON	AUMAN BJ4253 TRACTO CAMION	2012	CUMM. ISM E420 30		A9080SP	ASR90TDS	
FOTON	AUMAN	2015	CUMM ISG GTL 3835				
FOTON	AUMAN BJ1226 EURO V	2021-2023	Cummins ISD 6,7 270 Hp		A7898SP	A7813SP / ASR90TSP	
FOTON	AUMAN BJ1186 EURO V	2018> 2021	Cummins ISD 6,7 245 Hp		A7898SP	A7813SP / ASR90TSP	
FOTON	FTR PLUS BJ5166 EURO IV	2018> 2021	Cummins ISD 6,7 210Hp		A7898SP	A7813SP / ASR90TSP	
FOTON	AUMAN BJ5166 EURO V	2018> 2021	Cummins ISD 6,7 210Hp		A7898SP	A7813SP / ASR90TSP	
FOTON	AUMAN GTL3835 TRACTO CAMION	2015	CUMM. ISG		A9080SP	AS1003SP / AS46018SP	AW2016SP
FOTON	AUMAN MINI MULA BJ4183	2012	CUMM. L340-20	AP3838	A354	A243004SP / A787	AW2010SP
FOTON	BUS CHASIS, BJ6126	2010	CUMM D_FENG L360		A9009SP	A243004SP / A787	AW2010SP
FOTON	VOLQUETA 4X4 BJ3042 DIESEL 120HP	2009	YC4D120-21 YUCHAI	APC203252	A134	P3461	
FOTON	AUMAN EST	2021>	Cummins ISG 11.8 LTS EURO V				
FREIGHTLINER	CASCADIA	2012>	DETROIT SERIE 60		A495SP (2)	A96SP / A97SP / AS5850SP	
FREIGHTLINER	NEW CASCADIA	2020	DETROIT DD15 EURO V 15 LTS 19 TON		PP7505	PP46235 / PP9908 KIT	PP5092
FREIGHTLINER	NEW CASCADIA	2020	DETROIT DD13 EURO V		PP7505	PM19915SP	PP5092
FREIGHTLINER	114SD VOLQUETA	2018>	CUMM ISL 8.9 LTS 20 TON		A3000SP / A1SP	PM19765SP	AP31036
FREIGHTLINER	114SD	2018>	DETROIT DD13 RO V		PP7505	PM19915SP	PP5092 / AC: AP31036
FREIGHTLINER	CL 120 COLUMBIA 6X4	2005>	DETROIT SERIE 60	AP3518 / AP3518SY	A495SP (2)	A97SP / A7301DSP	AW5137SP / AC: AP31037
FREIGHTLINER	CL 120 COLUMBIA 6X4	2005>	DETROIT SERIE 60	AP2705	A495SP (2)	A97SP / A5813SP	AW2010SP / AC: AP31037
FREIGHTLINER	CLASSIC XL TRACTO CAMION	2007	CUMM. ISX 400ST	AP3539	A9080SP	AS1040SP / PM7680	AW2127SP
FREIGHTLINER	COLUMBIA CL 120	2005>	CUMM. ISX 450	AP3518 / AP3518SY	A9080SP	AS1040SP / PM19765SP	AW2127SP / AC: AP31037
FREIGHTLINER	FL 106	1993	DETROIT SERIE50		A116SP / A777SP	A96SP / A97SP	AW5137SP
FREIGHTLINER	FL 106	1994>	DETROIT SERIE50		A495SP (2)	A96SP / A97SP	

MARCA	LÍNEA	AÑO	MOTOR	AIRE	ACEITE	COMBUSTIBLE	OTROS
FREIGHTLINER	FL 80 DOBLE TROQUE	1994	MERC OH366A	AP2690		PM324 / A243004DSP	
FREIGHTLINER	FL 80 DOBLE TROQUE CUMM	1994	CUMM.	AP2690	A3000SP	A787 / AS1441SP / A243004DSP / A43SP	AW5137SP
FREIGHTLINER	FL 88 CAMION	1994	CAT 12		A69SP	A614 / ASR90TSP	AW5137SP
FREIGHTLINER	FLD 112 FLD 112	2000	CUMM. M-11	AP2705	A3000SP	A1212SP / ASV1212SP	AW5137SP
FREIGHTLINER	FLD 120	1995	DET SERIE 60	AP2705	A116SP / A777SP	A96SP / A97SP	
FREIGHTLINER	FLD 120 DOBLE TROQUE	2005>	CUMM. N14 PLUS	AP2705	A9009SP	A23SP / A23ASP / A1212SP / ASV1212SP	AW5137SP
FREIGHTLINER	FLD 120 SD	1997	CUMM. C8,3	AP57MD33	A3000SP	A23L39SP	AW5137SP
FREIGHTLINER	FS65	N/D	CAT 3126 7,2L	AP2690	A67SP		
FREIGHTLINER	M2 106 (PATINETA), BUSINESS CLASS	2005>	MBE900		PP9452	PP7735	AP31036
FREIGHTLINER	M2 106, BUSINESS CLASS	2020>	CUMM. ISL 8.9 LTS EURO V		A9009SP	PM19728SP	
FREIGHTLINER	M2 106, BUSINESS CLASS	2020>	MBE900		PP9452	PP7735 / PM19728SP	AP31036
FREIGHTLINER	M2 106 4X2 (PATINETA)	2005>	OM 906LA	AP2690	PP9452	PP7735 / AS5850SP	AP31036
FREIGHTLINER	M2 112 TRACTO CAMION	2007-2020	MBE4000 12.8 LTS		PP7230SP	PP7761 / AS5850SP	AP31036
HINO	160 GD, GH	2002-2004	HINO 160	AP2688 / AP2621	A7105SP	A3627 / A034L / AS1441SP	
HINO	211, 225, 235	N/D		AP2520		PM9885111911	
HINO	500 FG81, FM81, GH81	2015>	J08E-UB 7.6Lts EURO IV	AP1325 / AP1330E	A7105SP	A034L / AS1441SP	
HINO	BUS RK 1J	2005>	J08C-TT 250HP	AP13190 / AP13190SY	A7105SP	A034L / AS1441SP	
HINO	CAMION	N/D	MOTOR 175 185 195	AP2520		PM9885111911	
HINO	FC500 - FM1J	2011>	J08C TT TURBO	AP1325 / AP1330E	A7105SP	A034L / AS1441SP	
HINO	FC500 FG 1J CAMION	2005>	J08C TT TURBO	AP1325 / AP1330E	A7105SP	A034L / AS1441SP	
HINO	FG1626 - GH1826 SERIE 500	2015	J08E 7684	AP1325 / AP1330E	A7105SP	PP13110 / PM1730SP	
HINO	GH8J	2021	J08C WP 7.7. LTS EURO V	AP1325 / AP1330E	A7105SP	PP11690SP / A23251SP / PM1730SP	
HINO	FM1A	2019>	A09 8.9 345 HP EURO IV	AP23030 / AP23030SY	A7105SP	PP11690SP / A23251SP / PM1730SP	
HINO	FM1J	2006-2011	J08T	AP1325 / AP1330E	A7105SP	A034L / AS1441SP	
HINO	GD 1J CAMION	2007>	J08C-TW	AP1325 / AP1330E	A7105SP	A034L / AS1441SP	
HINO	SERIE 500 GH	2012-2014	EURO III 7.6 LTS	AP1325 / AP1330E	A7105SP	PP11682SP / PM1730SP	
HINO	SERIE 500 GH	2012-2014	TURBO DIESEL	AP1325 / AP1330E	A7105SP	A034L / AS1441SP	
HINO	HINO CAMION CECA	N/D	J05C, J07C		A2210SP		
HINO	SERIE 700 FS1E	2007	HINO E13C 400HP	AP17845 / AP17846	PM1650 / PM72281SP	A23SP / A23ASP / PP202030	
HINO	SG1A MINI MULA	2019>	A09 8.9 345 HP EURO IV	AP23030 / AP23030SY	A7105SP	PP11690SP / A23251SP / PM1730SP	
HINO	SUPER HINO FF	N/D		AP812105	A7105SP	A15 / A941SP	
HINO	W06E	1998-1999	DIESEL	AP2688 / AP2621	A205SP	A034L / A23SP	
HINO	W06E	1998-1999	DIESEL	AP2688 / AP2621	A205SP	A034L / A15	
HINO	500 FG8J, GH8J, FM8J, GD8J, RK	2011-2022	J08E UB 7.7 LTS 247 HP, EURO IV	AP1325 / AP1330E	A7105SP	PP13110 / A034L / PM1730SP	

MARCA	LÍNEA	AÑO	MOTOR	AIRE	ACEITE	COMBUSTIBLE	OTROS
HINO	RK1J	2004-2015	J08C TT , 8.0 LTS 250 HP , 11 TON	AP13190 / AP13190SY	A7105SP	PP13110 /A034L / AS1441SP	
HYUNDAI	HD1000 TRACTO	2005>	404 HP		PM84001SP / PM54236E	A84040SP	
HYUNDAI	HD120 TURBO EURO III	2016>	D6DA22	AP6A701	PP52001	A8000SP	
HYUNDAI	HD120 DOBLE TROQUE VOLQUETA EURO III	2008>	D6DA19	AP6A701	A43175SP	A8000SP	
HYUNDAI	HD270	2002-2005	D8AY		PM53103E / PM54236E	A56670	
HYUNDAI	HD270 DOBLE TROQUE	2006-2011	D6CA38B EURO II		PM84001SP / PM54236E	A56670	
HYUNDAI	HD370	2006-2011	D6CA38B		PM84001SP / PM54236E	A84040SP	
HYUNDAI	HD270 DOBLE TROQUE, MIXER	2012>	D6CA38B	AP7C000	PM84001SP / PM54236E	A84040SP	
HYUNDAI	HD320	2007-2012	D6AC DIESEL	AP2211	PM53103E / PM54236E		
HYUNDAI	HD320 DOBLETROQUE	2013->	D6CC EURO IV	AP7C000	PM84001SP / PM54236E	A84040SP	
HYUNDAI	HD370 VOLQUETAS	2006>	380 HP		PM84001SP / PM54236E	A84040SP	
INTERNATIONAL	1700 LOADSTAR	1990-2003	DT466	AP182028 / AP137640	A1165P / A777SP	A23	
INTERNATIONAL	2674 CAMION	2004	CUMM. L10-300		A3000SP	A1212SP / ASV1212SP	
INTERNATIONAL	2674 VOLQUETA	N/D	CAT 3406	AP3518 / AP3518SY	A1165P / PMX750R / A777SP	A614	AW5137SP
INTERNATIONAL	4700 CAMION	1993-1996	DT 466	AP182028 / AP137640	A309SP (2)	A588SP / A23L39SP	AW2010SP
INTERNATIONAL	4700 CAMION	1997-2002	IHC 466	AP3548 / AP3722	A408SP	A588SP / AS830SPSP / A1345SP	
INTERNATIONAL	4700 CAMION DIESEL	1990-1995	DT 466	AP182028 / AP137640	A408SP	A588SP / AS830SPSP / A1345SP	AW2010SP
INTERNATIONAL	4700 CAMION DIESEL	1990-1995	IHC 444E	AP2863 / AP3501	A3786SP	AS830SPSP / A1345SP	AW5137SP
INTERNATIONAL	4700 CAMION DIESEL	1990-1995	DT 360	AP182028 / AP137640	A309SP (2)	A588SP / A23L39SP	AW2010SP
INTERNATIONAL	4900 CAMION	1994-1997	IHC 408	AP182028 / AP137640	A408SP	A588SP / AS830SPSP / A1345SP	
INTERNATIONAL	7300 WORKSTAR	2016	MAXX FORCE	AP4636 / AP4637	A9025SP	PM19684SP	AP43042
INTERNATIONAL	7600 DOBLE TROQUE VOLQUETA	N/D	CAT C12	AP4862 / AP4863	A69SP	A614	
INTERNATIONAL	WORKSTAR 7600I	2005-2022	CUMM. ISM 400	AP4862 / AP4863	A9080SP	PM19624SP	AW5137SP / AC: AP43042
INTERNATIONAL	8200; 8300 TRACTO CAMION	2002	CUMM		A3000SP	A23SP / A23ASP / A1212SP / ASV1212SP	
INTERNATIONAL	8600 TRANSTAR	2006	CUMM ISM	AP4862 / AP4863	A69SP	A614 / PM19624SP	AW5137SP
INTERNATIONAL	9400I EAGLE	2005-2015	CUMM ISX 430	AP3518 / AP3518SY	A9080SP	AS1040SP / PM7680	AW2127SP
INTERNATIONAL	Buses 3100 FE/SCD 4.8L diesel	2015>	4.8L /MAXFORCE EURO IV	AP3548 / AP3722	PP2620SP	A1006SP / AS1249SP	
INTERNATIONAL	BUSETA	2005	T444E	AP182028 / AP137640	A3786SP		AW2010SP
INTERNATIONAL	CAMIONES	N/D	D155		A48SP	A243004SP / P346P	
INTERNATIONAL	CAMIONES	N/D	D282		A48SP	A1P2299 / A23L39SP	
INTERNATIONAL	DOBLETRO 7400 6X4	2006-2009	DT-466	AP4636 / AP4637	A408SP	A588SP	AW2010SP / AC: AP43042

MARCA	LÍNEA	AÑO	MOTOR	AIRE	ACEITE	COMBUSTIBLE	OTROS
INTERNATIONAL	SERIES 4300	2001-2018	IHC DT466E	AP4636 / AP4637	A408SP	A588SP / A1345SP	AP43042
INTERNATIONAL	DURASTAR 4300	2016	MAXX FORCE	AP4636 / AP4637	A9025SP	PM19684SP	AP43042
INTERNATIONAL	4300 DURASTAR	2001-2018	DT466 E	AP4636 / AP4637	A408SP	A588SP / A1345SP	AP43042
INTERNATIONAL	DURASTAR 4300	2016	CUMMINS ISB 225 HP EURO V		A7177SP	A7813SP	
INTERNATIONAL	EAGLE 9400	2004-2005	CUMM. ISX	AP2654 / AP2654SY	A9080SP	AS1040SP / PM7680	AW2127SP
INTERNATIONAL	EAGLE 9400 2006 EN ADELANTE EQUIPOS INTERNATIONAL	2006->	CUMM ISX 430	AP3518 / AP3518SY	A9080SP	AS1040SP / PM7680	AW2127SP
INTERNATIONAL	MINI MULA 4400	2005>	IHC DT530	AP4636 / AP4637	A408SP	A588SP / AS830SPSP / A1345SP	AW2010SP / AC: AP43042
INTERNATIONAL	PAYSTAR 5000	1995>	IHC 466	AP182028 / AP137640	A309SP / A48SP	A588SP / A23L39SP	AP43042
INTERNATIONAL	PAYSTAR 5000	1995>	CUMM.		A116SP / PMX750R	A23L39SP	
INTERNATIONAL	PAYSTAR 5600	2006	CUMM. ISX	AP3518 / AP3518SY	A9080SP	AS1040SP / AS46018SP	AW2127SP
INTERNATIONAL	PROSTAR	2012>	CUMM. ISX	AP4862 / AP4863	A9080SP	PM19765SP / AS1040SP	AW2010SP
INTERNATIONAL	SERIE 7400 - 9400 TRACTO CAMION	2005	MAXX FORCE	AP4636 / AP4637	A9025SP	PP19684SP / AS46018SP	AW2010SP / AC: AP43042
INTERNATIONAL	SERIE 7400 CAMION	2004 ->	IHC DT530, DT570	AP4636 / AP4637	A408SP	A588SP / AS830SPSP / A1345SP	AP43042
INTERNATIONAL	SERIE J070 PYASTAR	N/D	CUMM.		PM343 / A116SP / PMX750R	A23SP / A23ASP / A1345SP	AW2010SP
INTERNATIONAL	SERIES HV 607 EURO V MINI MULA	2020-2022	CUMM ISL 9000 cc		A7177SP / A1SP		AP43100
INTERNATIONAL	SERIES MV 607 EURO V	2020-2022	CUMM ISB 6700 cc		A7177SP		AP43100
INTERNATIONAL	TRACTO CAMION 9900I	2000-2013	CUMM. ISX 15	AP3518 / AP3518SY	A9080SP	AS1040SP / PM7680 / PM19765SP	AW2127SP
INTERNATIONAL	VOLQUETA - CHASIS 7600 6X4	2008-2009	CUMM. M11	AP4862 / AP4863	A3000SP	A1259SP	AP43042
INTERNATIONAL	VOLQUETA - CHASIS 7600 6X4	2008-2009	CAT C10		A69SP / A777SP	A614	
INTERNATIONAL	VOLQUETA CAREGATO 7600	2005>	CUMM. ISX	AP4862 / AP4863	A9080SP	PM7680	AW2127SP / AC: AP43042
IVECO	170 E 22 CAMION	2001	TECTOR 235HP	AP41702 / AP41702SY	A7898SP	A7813SP	
IVECO	170 E 22 HT MINI-MULA	2006	170 E 22 HT		A232SP	A1217/ A243004DSP	
IVECO	380 E 37 H DOBLE TROQUE	2006	380 E 37 H		A232SP	A243004DSP	
IVECO	EUROCAR 150E23	N/D	SERIE 8060		A232SP	A4618310	
IVECO	MP-380E DOBLE TROQUE	N/D	DIESEL	AP9835	A325SP	A243004SP	
IVECO	MP-400E-30 y 400E34 CAMION	N/D	8210/42			A243004SP / A1218	
JAC	3251 VOLQUETA	2008>	CUMMINS ISM	AP5538 / AP5538SY		A1259SP	
JAC	CAMION JAC 1131	2007>	CUMM.	AP2211	A3000SP	A243004SP / A1259SP	
JAC	JAC 4183 30 TON	2011-2016				A8059	
KAMAZ	53212, 54112, 55111	N/D	CUMMINS		A3000SP	A23SP / A23ASP	
KAMAZ	53212, 54112, 55111	N/D	KAMAZ				
KENWORTH	C500	1985	CAT 3406	AP2489	A69SP	A614 / A1218	AW5137SP
KENWORTH	CUMMINS C500	1985	ISX C500	AP3539	A9080SP	A7766SP	AW2127SP

MARCA	LÍNEA	AÑO	MOTOR	AIRE	ACEITE	COMBUSTIBLE	OTROS
KENWORTH	DTL-10 DOBLE TROQUE	N/D	CUMM. LT10		A116SP / A777SP	A23SP / A23ASP / A1212SP / ASV1212SP	AW2010SP
KENWORTH	T880 MX13	2019>	PACCAR MX13 12.9 LTS				
KENWORTH	L700, T800W	N/D	CAT 3306		A69SP	A1P2299 / A23L39SP	
KENWORTH	MINI MULA T300 6X4 (ELIMINAR LA FILA)	N/D	CAT 3406	AP2863	A67SP / A777SP	A1R0751SP	
KENWORTH	T2000 TRACTO - MULA	2005-2007	CUMM. ISX 450		A9080SP	AS1040SP / PM7680	AW2127SP
KENWORTH	T2000W	2004	CUMM. N14	AP3548 / AP3722	A3000SP	A1212SP / ASV1212SP	
KENWORTH	T300	1998-2000	CAT 3126B 7,2L	AP2863	A67SP	A1259SP	
KENWORTH	T300	1998-2000	CUMM. 8.3L	AP2863	A3000SP	A243004 / A43SP	
KENWORTH	T300	2006->	ISC	AP2863 / AP3501	A3000SP	A588SP / AS1003SP	AW2010SP
KENWORTH	T300 DOBLETROQUE	2006->	CUMM. ISC 300	AP2863 / AP3501	A9009SP	A888 / AS1003SP	AW2010SP
KENWORTH	T300 DOBLETROQUE	2007->	CUMM. ISB	AP2863	A339SP	A23SP / A23ASP	AW2010SP
KENWORTH	T370 ISC	2008-2015	CUMMINS ISC 8,3 LTS	AP2863	A3000SP / A1SP		
KENWORTH	T370 CAMION 4X2 Y 6X4	2008-2015	ISB CUMM.	AP2863	A9009SP		
KENWORTH	T600 TRACTO CAMION	2005>	CUMM. ISX	AP2863	A9080SP	A7766SP	AW2127SP
KENWORTH	T600,	N/D	CAT 3406	AP2705	A69SP	A614 / A1259SP	AW2010SP
KENWORTH	T600A	N/D	CUMM. N14	AP2863	A3000SP	AS1040SP	AW2127SP
KENWORTH	T600A TRACTO CAMION	N/D	CAT 3306	AP2705	A67SP	A23SP / A23ASP	
KENWORTH	T660	2008-2017	CUMM ISM-ISX		A9080SP	PM19675SP	AW2127SP
KENWORTH	T470	2021-2022	CUMM ISL				
KENWORTH	T460	2017-2021	CUMM ISL		A9080SP	AS1003SP / PM19728SP	
KENWORTH	T680	2018-2022	CUMM X15		A9080SP		
KENWORTH	T880	2019-2022	CUMM X15 14,9 LTS		A9080SP		
KENWORTH	T800	1996-1999	CUMM. L10		A116SP / A777SP	A23SP / A23ASP / A1212SP / ASV1212SP	AW2010SP
KENWORTH	T800	2010>	CUMM. ISX RANCHERA 13"	AP4986 (2)	A9080SP	AS1040SP / PM19765SP	AW2127SP
KENWORTH	T800	N/D	CAT 3406B	AP2705	A69SP	A614	
KENWORTH	T800 BAJO CAPO RANCHERA	2011>	CUMM. ISX		A9080SP	AS1040SP	AW2127SP
KENWORTH	T800 BAJO CAPOT	2000-2010	CUMM. ISX 450	AP2705	A9080SP	AS1040SP / PM19765SP	
KENWORTH	T800 RANCHERA	1996-1999	CAT C15	AP3539 (2)	A69SP	A614 / A1259SP	AW5137SP
KENWORTH	T800 RANCHERA AMERICANA 15"	2000-2012	CUMM ISX 450		A9080SP	AS1040SP / PM7680	AW2127SP
KENWORTH	T800 RANCHERA MEXICANA 13"	2000-2010	CUMM. ISX 400	AP3539 (2)	A9080SP	AS1040SP / PM19765SP	AW2127SP / AC: AP43100
KENWORTH	T800 TRACTO CAMION	1996-1999	CUMM. ISM	AP3539 (2)	A9080SP	A7766SP / A23SP / A23ASP / AS1040SP	AW5137SP
KENWORTH	T800 10.8 LTS EURO V	2020-2022	CUMM. ISM 11		A9080SP / A1SP	A1259SP / PM7680	AW2010SP
KENWORTH	T800 TRACTO CAMION BIG CAM	1996-1999	CUMM. 400		A3000SP	A23SP / A23ASP / A1212SP / ASV1212SP	AW2010SP
KENWORTH	T800 VOLQUETA	2013>	CUMM. ISM 335		AR29SP / A9080SP	A1259SP	AW5137SP
KENWORTH	T800W	1996-1999	CUMM. N14		A3000SP	A23SP / A23ASP / A1212SP / ASV1212SP	
KENWORTH	T800W	1996-1999	CAT C12		A69SP	A23SP / A23ASP / A1212SP / ASV1212SP	

MARCA	LÍNEA	AÑO	MOTOR	AIRE	ACEITE	COMBUSTIBLE	OTROS
KENWORTH	T900, T900B	N/D	CAT 3306 -08	AP2482	A67SP	A23SP / A23ASP	
KENWORTH	TRACTO CAMION RANCHERA 13"	2010>	CUMM. ISX	AP4986	A9080SP	AS1040SP	AW2127SP / AC: AP43100
KENWORTH	TW800, TW900 CARC CROMADA	N/D	CUMM.		A1165P / A777SP	AR165P	
MACK	MACK RD600	1975	DM611,DMM611 ,R611,RD611	AP57MD31	A67SP (2)	A31SP / A30SP	AW2022SP
MACK	CAMION CX-613 VISION	2004	Motor E-7 355 E-TECH	AP2680 / AP3936	A67SP	A7656E / A7657	AW475SP
MACK	CAMIONES MACK	1977	ENDT675, END676			A150F	
MACK	CH613, RD690S CX613	2000	E7-454	AP57MD33	A67SP	A31SP / A30SP	AW475SP
MACK	CH613, TRACTO CAMION DIESEL	2000	E7-350	AP2680	A67SP	A31SP / A150F	AW475SP
MACK	CS200P,CS250P, 300	1985	CS200P	AP2677	A67SP	A31SP / A30SP	AW475SP
MACK	CV713 D-TROQUE GRANITE 427	2004 >	E7-427 E-TECH ELEC	AP2680	A67SP (2)	A7656E / A7657	AW475SP
MACK	CV713 D-TROQUE GRANITE 350-380	2004>	E7-350, 380 E-TECH	AP2680 / AP3936	A67SP (2)	A7656E / A7657	AW475SP
MACK	DM, MC, MR, R, U; CRUISE LINER 5	N/D	MAXY 300 6 Cyl.		A67SP	A31SP / A30SP	
MACK	DM600, R600, RD600, U600	N/D	END T673	AP57MD33	A67SP (2)	A31SP / A150F	AW2022SP
MACK	DM690S	N/D	E7-700		A67SP (2)	A31SP / A150F	AW475SP
MACK	EM6-237,EM6-237R,E6-250	N/D	CAT 3406		A67SP	A31SP / A150F	AW2022SP
MACK	GRANITE	2004	DIESEL AMI370	AP2680	A67SP / A7685SP	A8059 / PP202030	
MACK	GRANITE	2004	CHU612 MP8	AP3936	A67SP / A7685SP	A8059 / PP202030	
MACK	GRANITE CV713	2004- 2012	DIESEL AMI370	AP3936	A67SP (2)	A7657 / A7656E / PP202030	
MACK	RD600	1975	M.DIESEL	AP57MD21	A67SP	A31SP / A30SP	AW2022SP
MACK	RD690S	1990-1995	EM7-300	AP117797	A67SP (2)	A31SP / A30SP	AW475SP
MACK	RL688 RWL700	N/D	E6-250		A67SP (2)	A31SP / A150F	AW2022SP
MACK	SUPER LINER	N/D	CAT 3406	AP2680	A69SP	A614 / A1259SP	AW5137SP
MACK	SUPER LINER	N/D	MAXIDYNE 300		A67SP	A31SP / A30SP	AW2022SP
MACK	VISION	2012>	MACK MP8 12.8 LTS	AP3936	A67SP / A7685SP	A8059 / PP202030	
MACK	VISION 400 TRACTOMULA CX 613	2006>	E-TECH ELECT	AP3936	A67SP (2)	A7656E / A7657	AW475SP
MERCEDES BENZ	MB OM-3118	N/D	OM3118	APC203252		PM707 (3)	
MERCEDES BENZ	MB OM31	N/D	OM31	APC203252 / APC203252SY	PM0011843925	PM28S1Z	
MERCEDES BENZ	1214,(K), L1218, 1414,(K), L1418,(K)	N/D	OM 366A /LA		A309SP	A1204SP	
MERCEDES BENZ	1313, 2613	N/D	OM-352/OM-355		PM17	PM325 / PM28S1Z	
MERCEDES BENZ	1313, 2623	N/D	OM-327/OM-346		PM17	PM325 / PM707	
MERCEDES BENZ	1635, 44, 1733,35, 1748, 1838,40, 44	N/D	OM 442 LA		PM4031840025		
MERCEDES BENZ	1636 CAMION 2003	2003	OM-401		PM4031840025	PM28S1Z	
MERCEDES BENZ	1720 CAMION	2005-2009	1720 CAMION	AP5627 / AP5628	A309SP	ASR90TSP	
MERCEDES BENZ	814 BUS	2000	OM 0800			PM707 / PM324 / A1204SP	
MERCEDES BENZ	ACTROS 3332K	2019-2021	OM-501LA 11,9 LTS	AP84457 / AP84457SY		AS46018SP	
MERCEDES BENZ	ACTROS 4441K	2015-2019	OM-501LA 11,9 LTS	AP84457 / AP84457SY		AS46018SP	
MERCEDES BENZ	ACTROS 3341K/ 3344	2015	OM-541LA, 11.9 LTS	AP84457 / AP84457SY		AS46018SP	
MERCEDES BENZ	ACTROS 4140K	2009-2015	OM-541LA, 11.9 LTS	AP84457 / AP84457SY		AS46018SP	
MERCEDES BENZ	ACTROS 3335K	2008-2013	OM-541LA, 11.9 LTS	AP84457 / AP84457SY		AS46018SP	

MARCA	LÍNEA	AÑO	MOTOR	AIRE	ACEITE	COMBUSTIBLE	OTROS
MERCEDES BENZ	ACTROS 3853 AS	2012	OM-502LA, 15.9 Lts, 520Hp	AP84457 / AP84457SY		AS46018SP	
MERCEDES BENZ	LO712/37	2004-2006	OM364LA 4.0 LTS	AP3544P / AP3545	PP52001		
MERCEDES BENZ	ACTROS 2643, 3343, 48, 3240, 43	1996-2007	MERCEDES-BENZ OM501 LA	AP3838		PP7761	
MERCEDES BENZ	AXOR 2833K	2015-2018	OM-926LA, 7.2 Lts, 326 Hp 19 Ton	AP-25653 (SIN TAPA)	PP9452	PP7735 / AS46018SP	
MERCEDES BENZ	ATEGO 1016	2016>	OM904LA	AP-25653 (SIN TAPA)	PP7199	PP7735 / ASV1060SP	
MERCEDES BENZ	ATEGO 1017 (970-975)	2012>	OM904LA	AP-25653 (SIN TAPA)	PP7199	PP7735 / ASV1060SP	
MERCEDES BENZ	ATEGO 1725	2005->	OM906LA		PP9452	PP7735	
MERCEDES BENZ	ATEGO II 1315 EURO V	2017>	MERCEDES-BENZ OM-904 LA	AP-25653 (SIN TAPA)	PP9452	PP7735 / PP79915SP	
MERCEDES BENZ	ATEGO 1726 EURO V	2017>	MERCEDES-BENZ OM-926 LA EURO V	AP-25653 (SIN TAPA)	PP9452	PP7735 / PP79915SP	
MERCEDES BENZ	ATEGO 2730 EURO V	2017>	MERCEDES-BENZ OM-926 LA	AP-25653 (SIN TAPA)	PP9452	PP7735 / PP79915SP	
MERCEDES BENZ	BUS O-302, O-305	N/D	OM-327/352	APC203252	PM4031840025	PM707 / PM324	
MERCEDES BENZ	BUS MONOBLOCK	N/D	OM-352A	APC203252 / APC203252SY	A309SP	A1R0751SP	
MERCEDES BENZ	BUS O304, O404	N/D	OM 441LA				
MERCEDES BENZ	BUSES 366	N/D	OM 366	APC203252 / APC203252SY	PM4031840025	PM707	
MERCEDES BENZ	L912 TURBO	N/D	OM-364A			PM324 / A1204SP	
MERCEDES BENZ	MB 1720 4X2	2005>	OM-366LA	AP5627	A129SP	A1204SP / A7301DSP	
MERCEDES BENZ	MB MONOBLOCK	N/D	MB MONOBLOCK		PM0011843925	PM707	
MERCEDES BENZ	MERCEDES BENZ OH1636L	2005>	OH1636L		PM4031840025	A1345SP / PP204030 / PP204010	
MERCEDES BENZ	MERCEDES	N/D	OM-353A			PM707 / PM28S1Z	
MERCEDES BENZ	O500M / O500U	2004>	OM-906LA	AP5627 / AP5628	PP9452	PP7735	
MERCEDES BENZ	OH 1636L 6X4 BUS OH	2005>	OM 4000		PM4031840025	PP7761 / AS1441SP	
MERCEDES BENZ	OH 1636L CHASIS BUS	N/D	OM 447LA		PM0011843925	A1345SP / PP204030 / PP204010	
MERCEDES BENZ	OM401, OM402	N/D	OM-401, OM-402			PM707 / PM28S1Z	
NISSAN	FK617, FM617 CAMIONES	2000	FK617, FM		A1403SP	A56670	
NISSAN	175 BUS/CAMION REPOT	N/D	175 BUS/CAMION	AP2520H	A9003SP / A7018	A23SP / A23ASP / A941SP	
NISSAN	180 BUS-CAMIONES REPOT.	N/D	180 BUS-CAMIONES	AP2520H	PM1878100752	PM1878100270 / A46SP	
NISSAN	195 TURBO	N/D	195	AP812105	A408SP	A23SP / A23ASP	
NISSAN	200 BUS-CAMIONES REPOT.	N/D	200 BUS-CAMIONES	AP2520H	PM1878100752	PM1878100270 / A46SP	
NISSAN	235 CAMIONES	N/D	235 CAMIONE	AP2520	A9003SP	A941SP	
NISSAN	315 CAMIONES	N/D	315 CAMIONE	AP2520	A9003SP		
NISSAN	CAMIONES	N/D	325	AP2520	A48SP	A23SP / A23ASP	
NISSAN	DIESEL CAMION UD PKC 210	2005-2006	DIESEL CAMION	AP5021 / AP51250	A9003SP	A23SP / A23ASP	
NISSAN	NISSAN CAMIONES 175, HINO CAMI	N/D	NISSAN CAMIONES	AP812105		A330C / PM9885111911	
NISSAN	UD 1800, UD2000	1992>	FE6TA / FE6T	AP17845 / AP17846	A67SP	A23SP / A23ASP / AS1282SP	
NISSAN	UD 2000, UD2600	2003->	FE6/TA	AP5021 / AP51250	A1403SP	A23SP / A23ASP	AW2010SP
NISSAN	UD 2300	N/D	FE6/TA	AP812105		A941SP	AW2010SP
NISSAN	UD 2600, UD2800	2000	FE6/T	AP812105	A1403SP	A941SP	AW2010SP

MARCA	LÍNEA	AÑO	MOTOR	AIRE	ACEITE	COMBUSTIBLE	OTROS
NISSAN	UD 3000HD, UD 3000D	N/D	FE6TA / FE6T		A9N6007SP / A7018	A23SP / A23ASP	AW2010SP
NISSAN	UD PK212 MINI MULA	2002	FE6TC-21	AP5021 / AP51250	A1403SP	A23SP / A23ASP	
NISSAN	UD 3300	1998 - 1999	NE6T DI	AP812105 / AP114215145	A67SP	AS1249SP / AS1282SP / ASV1282SP	AW5137SP
NISSAN	UD 600 T	1993	NE6TA		A9003SP / A7018	A1212SP	AW2010SP
RENAULT	3000P MIDLINER	N/D	MACK	AP2677	A67SP	A30SPSP / AS11001SP	AW475SP
RENAULT	KERAX 380	N/D	DCI 11		A67SP / A7685SP	A8059 / AS11001SP	
RENAULT	PREMIUM 260	N/D	MIDR 06,02,45	AP2677	A67SP	A33358 / A243004DSP	
RENAULT	PREMIUM LANDER 380 DXI	N/D	DXI 11		A67SP / A7685SP	A8059 / AS11001SP	
RENAULT	PREMIUM LANDER DXI440	N/D				AS11001SP	
RENAULT	PREMIUM LANDER VIT 440 / 480 EURO VI	2013	DTI 13	AP15483 / AP15483SY	A67SP / A7685SP	A8059 / AS11001SP	
SCANIA	K410 B	N/D	DC13		PP10771	PP73018SP (No se fabrica) / ASR90TSP	
SCANIA	BUS K114, 124, 270, 310, 340 y 420	1996	DSC9	AP72152 / AP72154	A67SP	ASV90TSP	
SCANIA	BUS K1241B	1995	DSC9	AP72152 / AP72154	A67SP	ASV90TSP	
SCANIA	BUSES Y CAMIONES 2638	1990	MBZ 0M4571A	AP72152 / AP72154	A1SP	PM325	
SCANIA	CAMION P270/310	> 1977	DC9-12		A67SP	ASR90TSP	
SCANIA	L-LK140 E 141	2001	DS14		A20	A33358	
SHACMAN	X3000 460	2022	CUMMINS ISZ 460 EURO V		A9080SP	AS1003SP / AS88583SP	
SHACMAN	X3000 8X4 CUATRO MANOS	2021	CUMMINS ISM 440 EURO V	AP5538 / AP5538SY	A9080SP	AS1003SP / AS88583SP	
SHACMAN	X3000 4000 MINI MULA	2021	CUMMINS ISM 385 EURO V		A9080SP	AS1003SP / AS88583SP	
SITRAK	C7H TRACTO CAMION	2020	MANN MT13 43 50 EURO V GAS NATURAL	AP4971 / AP4971SY			
VOLKSWAGEN	Constellation 13-190 / 15-190 /17-190	2012>	CUMMINS 6BTA 5.9		PP7196	AS27177JSP	
VOLKSWAGEN	15-180	N/D	CUMMINS 6CT	AP5627 / AP5628	A3000SP	A787	
VOLKSWAGEN	15-190 CONSTELLATION	N/D	CUMMINS 6BTAA		A339SP	A243004	
VOLKSWAGEN	15-190 CONSTELLATION	2017>	MANN D08 34 4.6 LTS		PP7196	AS27177JSP	
VOLKSWAGEN	17-210 OD	2001-2003	CUMMINS 6BTAA	AP5627 / AP5628	A339SP	A243004 / A1212SP	AW5137SP
VOLKSWAGEN	17-280 CONSTELLATION	2013>	MANN D08 36 280 4,6 LTS 255 HP	AP5627 / AP5628	PP9452	AS27177JSP	AW5137SP
VOLKSWAGEN	18-310 WORKER Titan	2004	CUMMINS 6CTAA 8.3 DI	AP5627 / AP5628	A3000SP	A243004	AW5137SP
VOLKSWAGEN	DELIVERY 13-180	2000	MWM 6.10 TCA EURO III	AP5627 / AP5628	A840SP	A23SP / A23ASP / AS950SP / A950DSP	
VOLKSWAGEN	PRISMA 7100	N/D	MWM	APC203252 / APC203252SY	A840SP	A1345SP	
VOLKSWAGEN	SERIE 13- 190 CAMION	2001->	CUMM. 6BTAA	AP5627 / AP5628	A339SP	A243004SP / A243004DSP	
VOLKSWAGEN	SERIE 15-180 CAMION	2001->	MWM 6, 10 6CIL	AP5627 / AP5628	A349SP / A840SP	AS4057SP / AS950SP / A950DSP	
VOLKSWAGEN	CONSTELLATION 32-360	2019-2021	CUMM. ISL 8.9 LTS 360 HP	AP5627 / AP5628	A3000SP		

MARCA	LÍNEA	AÑO	MOTOR	AIRE	ACEITE	COMBUSTIBLE	OTROS
VOLKSWAGEN	SERIE 17- 210 CAMION	2004-2008	MWM 6, 12 ELECT	AP5627	A840SP	AS4057SP / AS950SP / A950DSP	
VOLKSWAGEN	SERIE 17- 210 CAMION-BUS OD	2001-2003	CUMM. 6BT 5.9T	AP5627	A349SP / A840SP	A243004SP / A43SP	
VOLKSWAGEN	SERIE 17- 220 CAMION	2001->	CUMM. 6CTAA	AP5627	A9009SP	A243004SP / A243004DSP	
VOLKSWAGEN	WONKER SERIE 18-310 TRACTOCAMION	2004->	CUMM. 6CTA 8.3	AP5627	A9009SP	A243004SP / A243004DSP	
VOLKSWAGEN	WONKER SERIE 26-260	2006->	CUMM. 6CTE	AP5627	A9009SP	A243004SP / A1204SP	
VOLKSWAGEN	Worker 15-190	2013	MANN D08 34 190 DI	AP17308 / APC203252SY	PP7196		
VOLKSWAGEN	15-180	2001	MWM 6.10, 6CIL	AP5627 / AP5628	A-349SP	AS1441SP	
VOLKSWAGEN	17-210	2004-2007	MWM	AP5627	A-349SP	AS1249SP	
VOLVO	BUS B-10M,58	N/D	THD-101KC		A67SP	A243004SP	
VOLVO	BUS B-12	N/D	THD-123ES		A67SP	A243004SP	
VOLVO	FM 370 TRACTO CAMION	2009	VOLVO D11 EURO5		A67SP / A7685SP	A8059 / AS11001SP	
VOLVO	FMX 420	2003	CUMM N14 PLUSS	AP9961 / AP65937SY	A9009SP	A1259SP	
VOLVO	N10 y N12 TURBO	N/D	TD121F		A67SP	A243004SP	
VOLVO	NH12 TRACTO-CAMION, DOBLE TROQUE	2006 >	VOLVO D12, D420		A67SP (2) / A7685SP	A8059 / AS4654SP	AW2237SP
VOLVO	NL-10-280-340	N/D	TD101G,102FS		A67SP	A243004SP	
VOLVO	Serie 770, Serie 610	N/D	VOL VED12		A67SP / A7685SP	A7653	
VOLVO	TRACTO CAMION	N/D			A116SP / A777SP	A243004SP	AW2010SP
VOLVO	TRANSMILENIO B7R	2000	D7B		A67SP (2) / A7685SP	A7653	
VOLVO	TRANSMILENIO B7R 285, B7R 260BP	2002>	D7B		A67SP (2) / A7685SP	A7653	
VOLVO	VOLQUETAS DUMPERS 4500	N/D	VOLVO DIESEL	AP2291 / AP4091			
VOLVO	VOLVO VN 430	N/D	CUMMINS ISX	AP3740	A9080SP	A7766SP	AW2127SP
VOLVO	VOLVO VN 430	N/D	VOLVO VED12	AP3740	A67SP / A7685SP	A7653SP / A8059 / PM19765SP	AW2127SP
YUTONG	ZK 6108 HGD 186HP	N/D	CUMMINS ISDe 6.7L				
YUTONG	ZK 6126	N/D	CUMMINS ISLe 8.9L		A3000SP		
YUTONG	ZK 6107HA	2012	CUMM. ISD 245		A7898SP	A7813SP / A106	
YUTONG	ZK 6107HA	2012	CUMM. ISD 270 EURO V	AP12020 / AP12020SY	A7898SP	A7813SP / AS1259SP	
YUTONG	ZK 6129 HA 340HP	2012	CUMMINS ISM 380-30 EURO III ELECT		A3000SP		
YUTONG	ZK6417HA EURO III ELECTRONICO	2012	CUMM. ISD 245		A7898SP	A7813SP / A1259SP	
YUTONG	ZK6720DF	2012-2015	ISDE 140-30		A7898SP	A7813SP / ASV90TSP	
YUTONG	ZK6831HE	2012	CUMM. EQB 210 ELECT	AP2216 / AP4416	A339SP	A243004SP / A243004DSP	
YUTONG	ZK6858	2011	CUMM. MECANICO	AP2216 / AP4416	A339SP	A243004SP	
YUTONG	ZK6858HA	2012	ISD 210 EURO III	AP2216 / AP4416	A7898SP	A7813SP / ASR90TSP /A1212SP	



ES JUSTO
LO QUE NECESITAS



GUÍAS DE FILTRACIÓN - MEDIANO



CO-SC-CER896120

MARCA	LÍNEA	AÑO	MOTOR	AIRE	ACEITE	COMBUSTIBLE
AGRALE	CHASIS MA 8.7 MA9.6	2014-2021	CUMMINS ISF 3.8 LTS 160 HP	APC20500 / APC20500SY	A840SP	AS1259SP
AGRALE	CHASIS MA 11	2017-2021	CUMMINS ISB 6.7 LTS 226 HP	APC23610 / APC23610SY	A339SP	A1212SP
AGRALE	CHASIS MA 9.0	2017-2021	MWM 4.12 TCE 4.8 LTS 177 HP	APC23610 / APC23610SY	A840SP	A96 / A1212SP
AGRALE	BUSETA 24 PASAJEROS.	2002-2006	MWM 6.5 TCA	APC20500 / APC20500SY	A840SP	ASR45SP / ASV45SP / A1205SP
AGRALE	BUSETA 26 PASAJEROS.	2002-2006	MWM 8.5 TCA	APC20500 / APC20500SY	A840SP	ASR45SP / ASV45SP / A1205SP
AGRALE	MA6.0 ; MA7.0 ; MA 8.5 : MA9.0	2000-2011	MWM 4.10 TCA 4.3 LTS	APC203252 / APC203252SY	A48SP	A1212SP / AS1441SP
AGRALE	BUSETAS MA8.5, MA 9.2 TCA	2005-2012	4.12 ; 6.0 , 7.0 y 8.5Lt	APC23610 / APC23610SY	A840SP	A1345SP / A1204SP
AGRALE	BUSETAS MWM MA 8.5 ELECTRONICO	2011>	MWM 8.5 ELECT	AP3548 / AP3722	A840SP	
CHEVROLET	NHR / NKR >2.5 TON DIESEL	2001>	ISUZU	AP2712	A4271SP	A4053SP
CHEVROLET	NHR CAMION TURBO	2000>	ISUZU 2.8 LTS	AP2712	A4271SP	A4053SP
CHEVROLET	NHR REWARD	2011>	ISUZU 2.8L 4JB1-TC	AP2877S	A4271SP	AK570SP
CHEVROLET	NHR REWARD EURO 4 CARGA	2012>	4JH1-TC	AP2877S	A4271SP	AK570SP
CHEVROLET	NHR REWARD EURO 4 CARGA	2012>	4JH1-TC	AP2877S	A4271SP	PP7355 (2)
CHEVROLET	NKR CAMION - BUS	1998-2000	ISUZU 2.8L	AP2712	A142SP	A4053SP
CHEVROLET	NKR CAMION, TURBO MICROBUS	2000-2010	ISUZU 2.8L	AP2712	A4271SP	A4053SP
CHEVROLET	NKR REWARD SERIE II Y III ELO	2011-2012	ISUZU 4JJ1-TC	AP2877S	PP88580	PP28970 / ASR90TSP
CHEVROLET	NKR REDWARD	2013	ISUZU 2.8 LITROS	AP2877S	PP88580	AK570SP
CHEVROLET	NRR REWARD	2022	ISUZU 4HK1-TCS 5.2 LTS EURO IV	AP21413	A2700SP	PP28970 / ASR90TSP
CHEVROLET	NLR REWARD	2022	4JJ1-TCC 3.0 EURO IV	AP21413	A4271SP	PP7355(2)
CHEVROLET	NLR REWARD TC LLANTA SENCILLA	2012	ISUZU 2.8 LTS	AP2877S	PP88580	AK570SP
CHEVROLET	NNR REDWARD	2011-2015	ISUZU 4JJ1-TCN	AP2877S	PP88580	PP28970 / ASR90TSP
CHEVROLET	NPR GNC BUSETON EURO IV (gas)	2017	4HV1 4.570 cc	AP2877S	A2700SP	
CHEVROLET	NPR - NQR	2011>	ISUZU-6HK1	AP2877S	A2700SP / A7041SP	A4054SP / A4053SP (2)
CHEVROLET	NPR / NQR 4,6 TON	2000-2010	ISUZU 4HK1-TCN	AP2877S	A2700SP / A7041SP	A4054SP / A4053SP (2)
CHEVROLET	NPR / NQR REWARD EURO IV 148 HP	2011-2021	ISUZU 4HK1-TCN	AP2877S	A2700SP / A7041SP	PP28970 / ASR90TSP
CHEVROLET	NPR CAMION	1998-2000	ISZ 4BDT2TC 5,9 Lt	AP2712	A4051SP / A4052SP	A4054SP / A4053SP (2)
CHEVROLET	NQR REWARD	2022	4HK1 TCN 5.2 LTS EURO IV 2WD	AP21413	A2700SP	PP7355 / ASR90TSP / AK570SP
CHEVROLET	NPR REWARD	2022	4HK1 TCN 5.2 LTS EURO IV 2WD	AP21413	A2700SP	PP28970 / ASR90TSP / AK570SP
CHEVROLET	NPS REWARD 4X4	2020	4HK1 TCN 5.2 LTS EURO IV 4WD	AP21413	A2700SP	PP28970 / AK570SP

MARCA	LÍNEA	AÑO	MOTOR	AIRE	ACEITE	COMBUSTIBLE
CHEVROLET	NQR	2010>	ISUZU-4HG1T	AP2877S	A7041SP	A4054SP / A4053SP (2)
DAF	CF85 360 VOLQUETA	2020-2022	PACCAR MX265 12.9 LTS EURO V	AP4959		AS88583SP
DAF	CF480	2020-2022	PACCAR MX13 12.9 LTS EURO V	AP4959		AS88583SP
DAF	CF410	2020-2022	PACCAR MX11 10.8 LTS EURO V			AS88583SP
DAF	LF280	2020-2022	PACCAR GR210 6,7 LTS EURO V			AS88583SP
DAF	LF250	2020-2022	PACCAR GR184 6,7 LTS EURO V		A7898SP	AS1003SP
DAF	LF250 ASTRONIC	2020-2022	PACCAR GR184 6,7 LTS EURO V		A7898SP	AS1003SP
DINA	DINA RUNNER 8G	2014	CUMMINS Westport ISL		A339SP	
DONG FENG	CAMION DONG FENG DUOLIKA 7 TON	2011>	CUMMINS EQB140-20	AP1063	A427SP	A243004SP / A43SP
DONG FENG	CAMION DONG FENG XIAOBA-JIMBA	2011>	YUCAHI YC4F100-20	AP1051	A54SP	A243004SP / A1226LSP
FAW	CA1073 TIGER V	2021				
FAW	CA1073 TIGER V 4,5 TON	2021				
FIAT	FIAT DUCATO	2020-2021	3.0 LTS	AP31874		
FORD	BUSETAS FORD ANDINA 7.3.DIESEL	N/D	7.3.DIESEL		A134	A1230 / AS1230SP
FORD	CARGO 815 LARGO Y CORTO	2001-2008	CUMM 4BT 3.9lt	AP17308 / APC203252SY	A427SP	A243004SP / AS1282SP / ASV1282SP
FORD	CARGO 816	2019	CUMM. ISB 4,5 EURO V	AP17308	A7898SP	A7813SP / AS1249SP
FOTON	AUMARK BJ 1039	2015-2020	2.8 LTS DIESEL EURO IV	AP2206	A2863SP	A1212SP / AS36209SP
FOTON	AUMARK BJ 1045	2019-2021	2.8 LTS DIESEL EURO IV	AP93019	PP17356	A1212SP / AS36209SP
FOTON	AUMARK BJ 1039	2015-2020	2.8 LTS DIESEL EURO IV	AP2206	PP17356	A1212SP / AS36209SP
FOTON	AUMARK BJ 1065	2016>	CUMMINS 2,8 EURO IV	AP93019	PP17356	A1212SP / AS36209SP
FOTON	AUMARK BJ 1065 3,5 TON	2018>	CUMMINS 2,8 LTS EURO IV	AP93019	A7898SP	PP5706 / A7301DSP
FOTON	AUMARK BJ 1078	2018>	CUMMINS ISF 3,8 EURO IV	AP93019	PP17356	A1212SP / AS36209SP
FOTON	AUMARK BJ 1126	2020	CUMMINS ISF 4.5 LTS EURO V	AP1126 / AP1126SY	A7898SP	PP5706 / ASR90TDSP
FOTON	FHR 2.9 TON XL BJ1044	2021	FOTON 4J28TC 2.8 LTS EURO IV	AP2231	A2863SP	A1212SP / AS36209SP
FOTON	AUMARK FHR 2.8 TON BJ1039	2020	FOTON 4J28TC 2.8 LTS EURO IV	AP2299	A2863SP	AS36209SP
FOTON	FHR 3.0 TON	2020	CUMMINS ISF 3,8 LTS EURO IV	AP93019	PP17356	AS36209SP
FOTON	FQR BJ1108	2021	CUMMINS ISF 3,8 154 HP EURO IV	AP93019	A7898SP	PP5706 / ASR90TDSP
FOTON	FPR BJ1078	2021	CUMMINS ISF 3,8 EURO IV	AP93019	A7898SP	PP5706 / ASR90TDSP
FOTON	FTR PLUS	2021	CUMMINS ISDE 210 6,7 LTS EURO V		A7898SP	A7813SP / ASR90TSP

MARCA	LÍNEA	AÑO	MOTOR	AIRE	ACEITE	COMBUSTIBLE
FOTON	FRR-S BJ1128	2021	CUMMINS ISF 3.8 LTS	AP93019	A7898SP	PP5706 / ASR90TDSP
FOTON	AUMAN BJ3319	2023	CUMMINS ISGE 400 11.8 LTS EURO IV			
FOTON	FRR PLUS BJ1126	2020	CUMMINS ISF 4,5 LTS 210 HP EURO V	AP1126 / AP1126SY	A7898SP	PP5706 / ASR90TDSP
FOTON	FKR	2021	CUMMINS ISF 2,8 EURO IV	AP93019	PP17356	AS36209SP
FOTON	FKR	2021	CUMMINS ISF 2,8 EURO IV	AP93019	A2863SP	AR16SP / AS36209SP
FOTON	AUMARK BJ1129	2018-2021	CUMMINS ISF 3,8 EURO IV	AP2251	A7898SP	PP5706 / ASR90TSP
FOTON	AUMARK CARGA	2014>	CUMM. ISF 5,9 TON	AP2251	A7898SP	PP5706 / A7301DSP
FOTON	AUMARK BJ1041 2.8 T	2015-2022	CUMM. ISF EURO IV	AP2231	PP17356	A1212SP / AS36209SP
FOTON	AUMARK BJ1049 2.8 T LLANTA SENCILLA	2016>	CUMM. ISF EURO IV	AP2231	PP17356	A1212SP / AS36268SP
FOTON	AUMARK BJ1051 4.8 T, 3.8 Lt	2015>	CUMM. ISF 3.8 LTS EURO IV	AP2251	A7898SP	PP5706 / A7301DSP
FOTON	AUMARK BJ1061 6.0 T, 3.8 Lt	2015-2020	CUMM. ISF EURO IV DI	AP2251	A7898SP	PP5706 / ASR90TDSP
FOTON	AUMARK BJ5039 95 HP BJ493Q3	2010	CUMM ISF 2.8 LTS EURO III	AP2239	A2863SP	AS200SP
FOTON	AUMARK CARGA	2009	1015 95 HP ,4JB1 TDA	AP2239	A2863SP	AS200SP
FOTON	FORLAND CAB SENCILLA CAMION	2006-2010	DIESEL	AP2206	A48SP	A243004SP / A243004DSP
FOTON	FORLAND DOBLE CABINA CAMION	2006	YZ4102ZLQ	AP2205	A48SP	A243004SP / A243004DSP
FOTON	OLIN 1035, 3,5 T CAB DOBLE	2010	110 HP YZ4102ZLQ	AP2244	A48SP	A243004SP / A243004DSP
FOTON	OLIN 1043, 3,5 T CAB DOBLE	2010>	110 HP YZ DIESEL	AP2240	A48SP	A243004SP / A243004DSP
FOTON	OLIN 1043, 3,5 T CAB SENCILLA	2010>	110 HP YZ DIESEL	AP2206	A48SP	A243004SP / A243004DSP
FOTON	OLIN 1043, 3,5 T CAB SENCILLA	2010>	110 HP YZ DIESEL	AP2263	A840SP	A243004SP / A243004DSP
FOTON	OLIN 1069 4,5 T CAB SENCILLA 135HP	2010>	PHASER - PERKINS	AP203823	A1SP	A243004SP / A243004DSP
FOTON	OLIN 1095, 2,2 T CAB SENCILLA	2010	EURO III 2490	AP2252	A2863SP	A4053SP
FOTON	OLIN 3.5 CAMION	2009-2010	3,5 TON	AP2206	A48SP	A243004SP / A243004DSP
FOTON	OLIN 4.5 CAMION	2009-2010	4,5 TON	AP203823	A1SP	A243004SP / A243004DSP
FOTON	OLIN 5081 5,8 T CAB SENCILLA	2014	5081 6.5 LTS	AP203823	A1SP	A243004SP / A243004DSP
FOTON	OLIN 5089 5,8 T CAB SENCILLA 154 HP	2010	CUMM. ISF 3,8 LTS	AP2251	A7898SP	PP5706 / ASR90TSP
FOTON	AUMAN BJ1166	2022	CUMMINS ISF 4,5 EURO V	AP1126 / AP1126SY	A7898SP	ASR90TDSP / ASR90TDSP
FOTON	AUMAN BJ5126	2019	CUMMINS ISF 4,5 / 185 HP	AP1126 / AP1126SY	A7898SP	PP5706 / ASR90TDSP

MARCA	LÍNEA	AÑO	MOTOR	AIRE	ACEITE	COMBUSTIBLE
FOTON	FVR BJ5186	2022	CUMMINS ISDE 245 6,7 LTS EURO V		A7898SP	A7813SP / ASR90TSP
HINO	CAMIÓN GD1J SERIE 500	2005>	J08C -TW	AP1325 / AP1330E	A7105SP	A034L / AS1441SP
HINO	CAMION	N/D	MOTOR 175	AP2520	A7105SP	A034L / A1212SP / ASV1212SP
HINO	CAMION	N/D	MOTOR 175	AP2520	A205SP	A034L / A1212SP / ASV1212SP
HINO	CAMION	N/D	MOTOR 155,165, 185	AP2520	A7105SP	PM9885111911 / ASR90TSP
HINO	CAMION 500 FG1J	2005	HINO J08C-TT	AP1325 / AP1330E	A7105SP	A034L / AS1441SP
HINO	CAMIÓN DUTRO MAX CITY 300, 4.000cc	2011-2016	616 N04C-TT 148HP	AP78020	A7144SP / A4048SP	PP1112 / PM1940
HINO	CAMION FC4J, FC500	2004>	J05C- TF	AP17871 / AP17871SY	A7105SP	A034L / AS1441SP
HINO	CAMIÓN FC9J EXPRESS	2013	E-7 350 E-TECH	AP17871 / AP17871SY	A7105SP	PP11682SP / PM1940
HINO	DUTRO 300	2007-2014	HINO N04C-TT	AP78020	A7105SP	A034L
HINO	XZU640L DUTRO 300	2023	NO4CVW 4.0 LTS EURO V	AP78090		
HINO	DUTRO 300 MAX EURO IV 6 TON	2013-2018	NO4CVC 4.0 LTS EURO IV-V	AP78090	A4048SP	PP1112 / PP78091SP
HINO	DUTRO 300 PACK EURO IV 3,3 TON	2013-2018	NO4CVC 4.0 LTS EURO IV-V	AP78090	A4048SP	PP1112 / PP78091SP
HINO	DUTRO 300 EXPRESS 4.2 TON	2013 -2017	NO4CVC 4.0 LTS EURO IV-V	AP78090	A4048SP	PP1112 / PP78091SP
HINO	DUTRO 300 CAMION	2008-2010	J05C	AP78020	A7144SP / A4048SP	A034L / PP7751
HINO	DUTRO 300 MAX EURO III	2011>	616 N04C-TT	AP2279	A4048SP	PP1112 / PM1940
HINO	DUTRO CAMION	2004-2007	HINO DIESEL	AP78020	A7105SP	A033 / PP7751
HINO	DUTRO EURO IV	2014-2015	DIESEL EURO IV	AP78020	A4048SP	PP1112 / PP78091SP
HINO	DUTRO 300 PRO 2,6 TON	2016- 2020	N04CUV 4.0 LTS EURO IV /V	AP78090	A7144SP / A4048SP	A4023SP /PP1112 / PP78091SP
HINO	FB 5JC PE BUS	2003	FB 5JC PE	AP3736 / AP3737	A7105SP	A034L / AS1441SP / A1345SP
HINO	FB-4J BUS	2003-2008	FB-4J BUS DIESEL	AP3736 / AP3737	A7105SP	A034L / AS1441SP / A1345SP
HINO	FB-4J BUS	2003-2008	FB-4J BUS DIESEL	AP3736 / AP3737	A7105SP	A034L / A23 / AS1441SP / A1345SP
HINO	FC 3W	1997	DIESEL	AP812105 / AP114215145	A7105SP	A034L / AS1441SP / A1345SP
HINO	FC4J CAMION	2004-2012	J05C TF 168 HP EURO II	AP17871 / AP17871SY	A7105SP	A034L / AS1441SP / A1345SP
HINO	FC9J BUSETON - CAMION LIGHT	2015>	J05E US 177 HP EURO V	AP17871 / AP17871SY	A7105SP	PP04041 / PM1940

MARCA	LÍNEA	AÑO	MOTOR	AIRE	ACEITE	COMBUSTIBLE
HINO	FM8J	2017>	J08E 7.7 LTS EURO IV	AP1325 / AP1330E	A7105SP	PP11682SP / PM1730SP
HINO	500 FC9J	2020>	J05EV 5,1 LTS EURO V		A7105SP	PPEV470 / PPEV430
HINO	FC9J LTZ BUSETON	2021	J05EVE 207 HP EURO IV		A7105SP	PP04041 / PM1940
HINO	HINO FC3	1980	ISUZU	AP812105 / AP114215145	A7041SP / PM7572	A034L
HINO	FC9J LTZ BUSETON	2021	J05EVE 207 HP EURO IV	AP80220 / AP80220SY	A7105SP	PPEV470 / PPEV430
HINO	HINO FC9J	2012-2014	J05ETC 5.1 LTS EURO III	AP17871 / AP17871SY	A7105SP	PP11682SP / PM1940
HINO	HINO, MOTORES 150- 205	N/D	DIESEL	AP2520	A205SP	A034L / A1212SP / ASV1212SP
HINO	SERIE 500 GDIJ	2008>	J08C-TW	AP1325 / AP1330E	A7105SP	A034L / AS1441SP
HINO	SERIE FA, FB, FE	2002-2003	HINO DIESEL	AP3736 / AP3737	A7105SP	A034L / ASR90TDSP
HINO	GB MINI BUSETA	2022	HINO N04-UC	AP80220 / AP80220SY		
HINO	GB	2013-2021	HINO N04C TT	AP78090	A4048SP	PP1112 / PP78091SP
HYUNDAI	BUS COUNTY	2012	D4DD / CRDI Euro II 3.3 y 4.0 lts 150HP	AP5A500	A7028SP	AS5850SP
HYUNDAI	CAMION CARGA T; CHIORUS	N/D	4.5 LTS	AP3500	A4731SP	A3726SP
HYUNDAI	CAMIONES Y BUSES C6AB/D6AB	2004-2008	HYN D6AB	AP8A900		
HYUNDAI	H250 - 350 CON TURBO	N/D	DIESEL	APH100	A4731SP / A291	A3726SP / AK570SP / A570DSP
HYUNDAI	HD65 / HD78	2011>	D4GA 3,9 LTS EURO IV	AP5A500	A7028SP	AS5850SP
HYUNDAI	HD65	2006-2019	D4DBD 3.900cc	AP5H100	A7028SP	A3726SP / AS5850SP
HYUNDAI	EX90 ; EX100	2018>	D4GA 3.9Lts 150HP EURO IV 6.1Ton	AP5M100	PP52001	AS7784D / AS5850SP
HYUNDAI	HD72 CHASIS CABINADO CAMION	2001	TCI D4DB	AP5H100	A28SP	A3726SP
HYUNDAI	HD78C / HD78BC	2016>	D4GA17 4.0 LTS EURO V	AP5A500	PP52001	AS7784D / AS5850SP
HYUNDAI	HD78 CAMION 4LTS 5.4T	2011-2015	3.3 Y 4.0 Lts, 150HP	AP5A500	A092SP	AS5850SP
HYUNDAI	K-350	N/D	DIESEL	AP7242	A7105SP	A3726SP
IVECO	100E15, 18, 21 CAMION y BUS	2001	IVECO		A232SP	A1217/ A243004DSP
IVECO	135-17 CAMION DIESEL	1995	DIESEL	APC203252	A232SP	P346P
IVECO	5912 MICROBUSETA, CHASIS	N/D	DIESEL	AP1908233	A232SP	A243004DSP
IVECO	65E 10 EURO CARGO	2000	DIESEL		A232SP	A243004DSP
JAC	1035	2016	2.8 LTS. DIESEL C. R.	AP2712 / AP2712SY	A2863SP	A243004SP / AS200SP
JAC	JAC 1040 - 1045	2003-2012	DIESEL	AP2224	A54SP	AS103SP / A243004DSP
JAC	JAC JPR POWER 1048	2018	WEICHAI 2.9 LTS EURO IV	AP2877S / AP2877SY	A54SP	A1345SP / AS1441SP

MARCA	LÍNEA	AÑO	MOTOR	AIRE	ACEITE	COMBUSTIBLE
JAC	JAC JPR 1048	2017	WEICHAH 2.9 LTS EURO IV	AP2877S / AP2877SY	A54SP	A1345SP / AS1228SP
JAC	JAC JPR POWER	2018	MAXXFORCE 3.2 LTS NAVISTAR	AP2877S / AP2877SY	A54SP	A7653 / AS1228SP
JAC	JAC JKR POWER 1040 ; 1042 MAX 2.8 Lts	2021	JAC HFC4DE1-1C EURO 4	AP85051	A52041SP	AS36268SP
JAC	JAC JHR POWER 1035 / 1036 2.8 Lts	2020>	JAC HFC4DE1-1C EURO 4	AP85051	A52041SP	AS36268SP
JAC	JAC JQR POWER 3.8 Lts	2017	CUMMINS ISF 3.8	AP2236	A7898SP	PP5706
JAC	JAC JRR 1120 POWER 3.8 Lts	2017-2021	CUMMINS ISF 3.8	AP2251	A7898SP	PP5706 / AS1228SP
JAC	1048 3.4 108HP	2014>	WEICHAH 3400 CC EURO II	AP2236	A810	A243004SP / AK570SP
JAC	JVR 1171	2020>	CUMM. ISD 45 6.7 LTS EURO V		A7898SP	A7813SP
JAC	JVR POWER BJ1137	2020>	CUMM. ISD 2.85 50 6.7 LTS EURO V		A7898SP	A7813SP
JAC	BUSETA CORTA 26 PASAJ	2006	CUMM. ISF 3,800		A54SP	AS103SP / A243004DSP
JAC	BUSETA HK6730, CHASIS LARGO 29 PASAJ	2006	3.9 Lt		A427SP	AS103SP / A243004DSP
JAC	BUSETON 39 PASAJ	2006	3.8 Lts DIESEL		A54SP	AS103SP / A243004DSP
JAC	CAMION JAC 1061	2011>	4 CILINDROS	AP2236	A427SP	A243004SP / A243004DSP
JAC	CAMION 1035 EUROII. 2 T	2011->	JAC 4CIL 2.771 cc	AP2712 / AP2712SY	A54SP	A243004SP / AK570SP
JAC	CAMION 1063	2009->	CUMM. 6BT 5,9Lt	AP2205	A427SP	A243004SP / A43SP
JAC	CAMION JAC 7.4	2013	7.4 LTS	AP2877S / AP2877SY	A7898SP	A7813SP / AS1228SP
JAC	CAMION JAC 1083	2013>	CUMM. ISF 3.8	AP2877S / AP2877SY	A7898SP	A7813SP / PP5706 / AS1228SP
JAC	CAMIONES 1040, 3T TURBO	2006->	JAC 4CIL 2.771 cc	AP2224	A447	AS103SP / A243004DSP
JAC	CHASIS BUSETA	2014	DIESEL	AP2291 / AP4091	A7898SP	A7813SP / ASR90TSP
JAC	JAC 1035	2012>	JAC 4CIL	AP2712 / AP2712SY	A2863SP	A243004SP (2) / AK570SP
JAC	JAC 1035 /1040 /1045	2012>	CUMM.	AP2253	A54SP	AS103SP / A243004DSP
JAC	JAC 1040-1045	2013>	DIESEL	AP2224	A2863SP	A243004SP / AS200SP
JAC	JAC 1120	2015>	CUMM. 4BT 6.5 TON	AP2877S / AP2877SY	A7898SP	PP5706
JAC	JAC JHR POWER 2.8 Lts EURO IV / JAC 1035	2018>	DIESEL 2.8 DI EURO IV	AP85051	A2863SP	A26000SP / AS12228SP / AS12228DSP
JAC	KING CAB 4,5 T CAMION 1010-1045	2006->	3.9 Lt	AP2224	A427SP	AS103SP / A243004DSP
JAC	POWERMAX HK6603B MICROBUS	2004	2.5 DIESEL		A2863SP	AS103SP / A243004DSP
JAC	AUMARK BJ 1061	2016-2021	CUMM ISF 3.8 LTS EURO IV	AP2251		
JBC	JBC 1030	2013	JBC	AP1030	A447	
JMC	JX 1032 ; 1043; 1053	2007-2015	ISUZU 4JB1 2.8 LTS DIESEL	AP23009	A4271SP	A4054SP

MARCA	LÍNEA	AÑO	MOTOR	AIRE	ACEITE	COMBUSTIBLE
JMC	CARRIYING 3,2 ; 3.7 TON JX1044TC4	2018>	ISUZU 4JB1 2.8 LTS DIESEL	AP23009	A2863SP	AS1249SP / AS200SP
JMC	NEW CARRIYING PLUS 1041; 1050; 1062 3.2 Y 4.5 TON JX1044TC4	2018-2021	ISUZU 4JB1 2.8 LTS DIESEL	AP39601	A2863SP	A1226 / AS200SP
JMC	NEW CARRIYING CHR 3.2 TON	2022	JMC 2.8 LTS JX493ZLQ4 TURBO	AP39601	A2863SP	A1226 / AS200SP
JMC	JX1083 TK24	2022	JMC 2.8 LTS JX493ZLQ4 TURBO	AP39601	A2863SP	A1226 / AS200SP
JMC	JX 1090	2014	YUCHAI 4260 cc	AP41702 / AP41702SY	A7223SP	A243004SP / A243004DSP
JMC	JX 1090	2014	YUCHAI 4260 cc	AP41702 / AP41702SY	A7223SP	
JMC	JX1043DSL2 2.5 y 3,2 TON FURGON	2009-2010	ISUZU 4JB1-T	AP3193	A4271SP	A4053SP / PM6630
MAZDA	T-45 CAMION	1990-1997	MZD D40A	APSL5013Z40A	A7144SP / A4049SP	P596
MERCEDES BENZ	1318 OH 2003	2003	1318	AP20457		PP7735
MERCEDES BENZ	ACCELO 715	N/D	OM612		PP7212	
MERCEDES BENZ	ACCELO 915 CAMION	2001->	OM 914LA	AP20457 / AP20457SY	PP7199	PP7735 / A1345SP / A7301DSP / ASV1060SP
MERCEDES BENZ	OF 917 BUS	2020->	OM 904LA EURO V	AP80006 / AP80006SY	A7028SP	A70401SP / AS1441SP
MERCEDES BENZ	ATEGO 813	2017>	OM 904LA EURO V	AP-25653 (SIN TAPA)	PP7199	PP7735 / ASV1060SP
MERCEDES BENZ	OF1218	2010-2014	OM 904LA 4,2 LTS	AP20457 / AP20457SY	PP7199	PP7735 / AS46018SP
MERCEDES BENZ	LO916	2015-2020	OM 924LA 4,8 LTS	AP20457 / AP20457SY	PP7199	PP7735
MERCEDES BENZ	OH1621 L	2019-2021	OM 447LA 4,8 LTS	AP20457	P403184002 5	A1345SP
MERCEDES BENZ	BUSES Y CAMIONES	N/D	BAL-7015	AP20457		PM707 / PM324
MERCEDES BENZ	BUSETAS B-14 02	2002	MB14	AP20457		PM707 / PM324 / A1204SP
MERCEDES BENZ	LO915 y 915L ALIMENTADOR 1417	2001	OM 904	AP20457	PP7199	PP7735 / AS0015SP / ASV1060SP
MERCEDES BENZ	LO 914, LO814	N/D	OM-364 LA	AP17308 / APC203252SY		PM324 / A1204SP
MERCEDES BENZ	LO914-915L BUSETAS 1417,	N/D	OM 904LA 4,2 LTS	AP20457	PP7199	PP7735 / AS0015SP / ASV1060SP
MERCEDES BENZ	LTC-915	2004	LTC 915		PP7199	
MERCEDES BENZ	MB 914E	2001	914E	AP20457	PP7199	PP7735 / ASV1060SP
mitsubishi	MITSUBISHI RP-118,	1996	DIESEL		PM53103E / PM54236E	A56670
MITSUBISHI	CANTER 1 VERSION	1996	DIESEL	AP3500	A4731SP / A291	A292
MITSUBISHI	CANTER 639: CAMION- MICROBUS	1997 -2013	AD34 3,9Lt	AP7242	A092SP	A292 / A3726SP
MITSUBISHI	CANTER CAMION	2014	TDI 3.9 LTS	AP7242	A7121SP	PP22135

MARCA	LÍNEA	AÑO	MOTOR	AIRE	ACEITE	COMBUSTIBLE
MITSUBISHI	CANTER FUSO CAMION	2016	2.7, 4.0 y 5.0T	AP7242	A1480	PP22135
MITSUBISHI	CANTER FUSO CAMION	2016	2.7, 4.0 y 5.0T	AP7242	A7028SP	PP22135 / AS46018SP
MITSUBISHI	FUSO CANTER 7.5M	2022	4P10KAT4 3.0 LTS EURO V			
MITSUBISHI	CANTER TURBO GB-FA500, 510 GB	1996-1998	TURBO GB	AP7242P	A4731SP / A291	A292
MITSUBISHI	FUSO FA 9.6	2017-2022	4D37 3,9 LTS EURO V	AP80006 / AP80006SY	A7028SP	A44 / AS1441SP
MITSUBISHI	FUSO FA 9.0 / FI 10.4	2017-2022	4D37 -125	AP80006 / AP80006SY	A7028SP	A70401SP / AS1441SP
MITSUBISHI	MITSUBISHI 4D34	1998-1999	4D34 DIESEL	AP3500	A7028SP	A292 / A3726SP
NISSAN	135 BUSETA	N/D	DIESEL	AP2877S	A9N6007SP / PMUD999	A941SP
NISSAN	135 CAMIONES ADAPTADOS	N/D	135 CAMIONES ADAPTADOS	AP2712	A20 / PMUD999	A7602
NISSAN	205 CAMIONES	N/D	205 CAMIONE	AP2712	A9003SP	A941SP / A1CSP
NISSAN	CABSTAR III CABINA SENCILLA/DOBLE	2009 - 2012	YD25 2.5 Lts	AP3270	A20	PFG448 / A5368SP / A1282SP
NISSAN	CABSTAR III CABINA SENCILLA/DOBLE	2009 - 2012	ZD30 ; ZD30H 3.5 LTS	AP3270	PP2200	PFG448 / A5368SP / A1282SP
NISSAN	BUS / CAMIONES MT3000	2008-2012	V6 3.0 LTS TURBO DIESEL	APG4800	A1SP	A1CSP / PP201030
NISSAN	CAMPEROS REPOTENCIADOS	1968-1980	NISSAN QD32	AP3600	A16242SP	A093DSP
NISSAN	CAMIONES MT3000TI TURBO DIESEL	2006>	TURBO DIESEL	APG4800	A1SP	A7533SP / PP201030
NISSAN	NISSAN DIESEL CAMION UD 41	1997-2000	4.5 TURBO DIESEL	AP2712	A1SP / PMUD999	A941SP / A1CSP
NISSAN	CABSTAR III	2017>	ZD30 ; ZD30H 3.0 LTS	APG4800	A1SP	PFG448
NISSAN	NON PLUS ULTRA	2002	DIESEL	APG4800	A9003SP	A941SP
NISSAN	TK55 MICRO BUS-BUSETA	2010-2014	YD 25 3.0 Diesel	AP3270	PP2200	PFG448 / A5368SP / PP201030
NISSAN	UD 40, 41	2000-2002	DIESEL	AP2712	A1SP (2) / PMUD999	A7614SP / A1CSP
NISSAN	UD 41CAMION 4,5T	2003>	DIESEL 4.5T	AP2712	A1SP (2) / PMUD999	A7614SP / A1CSP
NON PLUS ULTRA	8-160 ONIX PLUS	2016>	CUMMINS ISB 3,9 LTS EURO IV	AP41702 / AP41702SY	A427SP	A7813SP
PEUGEOT	EXPERT TURBO DIESEL	2019>	L3 2.0 HDI		A1402PLUS	
SINOTRUK	HOWO 5 TON	2019>	CUMMINS ISF 3.8	AP8213 / AP8313SY	A7898SP	PP5706 / AS1003SP
SINOTRUK	HOWO 2.8 TON	2019	JE493ZLQ4- 2.8 LTS	AP8213 / AP8313SY	A2863SP	AS200SP
SINOTRUK	HOWO 7 TON	2020	CUMMINS ISF 3.8 EURO IV	AP8222 / AP8222SY	A7898SP	PP5706 / AS1228SP
THOMAS	BUILT EF1723	2018	CUMMINS	AP3548 / AP3722	A7177SP	A7813SP / AS5850SP
TOYOTA	CAMION DINA 300	2004	DIESEL 3.7 LTS	AP78020		PP7751
VOLKSWAGEN	8-160 WORKER	2017	CUMMINS ISF 3.8 SCR 3.8 LTS EURO IV	AP17308 / APC203252SY	A7898SP	PP5706 / AS27177JSP

MARCA	LÍNEA	AÑO	MOTOR	AIRE	ACEITE	COMBUSTIBLE
VOLKSWAGEN	9-150 MOTOR MWM	2006>	MWM	AP17308	A840SP	A830 / AS950SP / A950DSP
VOLKSWAGEN	6-160 DELIVERY	2019>	CUMMINS ISF 2.8 LTS EURO V 156 HP		PP17356	PP79915SP
VOLKSWAGEN	9-160 OD VOLKSBUS	2017	CUMMINS ISF SCR 3.8 LTS EURO V	AP17308 / APC203252SY	A7898SP	PP5706 / AS27177JSP
VOLKSWAGEN	DELIVERY 9-170	2019	CUMMINS ISF SCR 3.8 LTS EURO V	AP17308 / APC203252SY	A7898SP	PP5706 / AS27177JSP
VOLKSWAGEN	DELIVERY 11-180	2019	CUMMINS ISF SCR 3.8 LTS EURO V	AP17308 / APC203252SY	A7898SP	PP5706 / AS27177JSP
VOLKSWAGEN	BUSETA 8-140	2002	MWM 4-10	AP17308 / APC203252SY	A840SP	AS950SP / A950DSP
VOLKSWAGEN	BUSETAS VOLKSWAGEN LT46	2002	MWM LT35		AL106	
VOLKSWAGEN	DELIVERY 10-160	2017	CUMMINS ISF 3.8 EURO V	AP17308 / APC203252SY	A7898SP	PP5706 / AS27177JSP
VOLKSWAGEN	SERIE 8-120; 8-140 y 8-150	N/D	MWM 4.10	AP17308 / APC203252SY	A840SP	A1204SP / AS950SP / A950DSP
VOLKSWAGEN	SERIE 9-150	2006->	MWM 5.2 TON	AP17308	A840SP	ASV60TSP
YUTONG	ZK 6107HA	2012	CUMMINS ISD 245 EURO III ELECT		A7898SP	A7813SP / A1212SP



ES JUSTO

LO QUE NECESITAS



GUÍAS DE FILTRACIÓN - LIVIANO DIÉSEL



CO-SC-CER896120

MARCA	LÍNEA	AÑO	MOTOR	AIRE	ACEITE	COMBUSTIBLE	OTROS
ASIA	ASIA HI TOPIC 715 / 725	1997-1998	715 -725	AP233	A3802N	AK570SP	
ASIA	ASIA HI TOPIC	1995-1998	715 -725	AP2562	A3802N	AK570SP	
ASIA	ASIA HI TOPIC 725	1995-1998	HI 725	AP1130E	A3802N	AK570SP	
ASIA	COMBI 715 - 815	2000	715 815	AP1130E	A091AE	A305F / A3726SP	
AUDI	Q5 TDI	2009-2012	2.0 LTS		PP15562		
CHEVROLET	COLORADO	2018>	2,8 CC DIESEL	AP48772	PP80215	PP71044 (2)	
CHEVROLET	CORSA Diesel TAXI 1,7 2002	2002-2007	ISUZU 1.7 Lt	AP6293	A1402PLUS	A1226LSP	
CHEVROLET	LUV D-MAX 4x2, 4x4 DLS	2005-2010	2.5 y 3.0 Lt	AP16550	A4050PLUS	A4053SP / A7533C	
CHEVROLET	LUV DIESEL 2200, 2300, 2600	2000-2003	ISUZU	AP2884	A2863SP	AK570SP	
CHEVROLET	LUV D-MAX RT 50 4x2, 4x4 DLS	2013-2021	ISUZU 4JK1 TC 2.5 Lts	AP352660	A8720CSP	PP7355	
CHEVROLET	TRAIL BLAZER	2013-2022	2,8 CC DIESEL	AP48772	PP80215	PP71044 (2)	
CITROEN	CITROEM JUMPER III	2006-2014	2.2 LTS	AP31874	PP358		
CITROEN	CITROEM JUMPER III	2006-2014	2.2 LTS	AP31874			
CITROEN	CITROEM JUMPY	2018-2021	2.0 LTS		A1402PLUS		
CITROEN	CITROEM JUMPER III	2006-2014	2.2 LTS	AP31874			
CITROEN	CITROEM JUMPER III	2006-2014	2.2 LTS	AP31874			
CITROEN	BERLINGO	2015-2022	1.6 Lt				
DAEWOO	DAEWOO MUSSO 602 TDI	2001-2017	602 TDI		PP50361		
DAIHATSU	CAMPERO ROCKY Diesel 94	1994-1999	2.8 Lt	AP0590E	A4046	A4047 / AK570SP	
DAIHATSU	DAIHATSU: DELTA	2002>	TURBO DIESEL B57	AP3193	A092SP	AK570SP	
DAIHATSU	DELTA	1999-2002	TOYOTA 14B	AP8040	A1SP	A4053SP	
DAIHATSU	DELTA B57	1999-2002	DIESEL B57	AP3193	A7028SP	A4053SP / AK570SP	
DAIHATSU	SUPER DELTA TURBO DIESEL	2002-2003	TOYOTA	AP8040	A7029SP	A4053SP / AK570SP	
DAIHATSU	V-126-125 MS MICRO, MINIBUSETA	2000-2006	158 FT		A1SP	A4053SP	
DODGE	RAM 2500	1998-2010	CUMMINS 5.9 LTS L6		A339SP		
DODGE	RAM 1500	2014-2019	3.0 LTS				
FORD	FORD 350	1992	4900CC	AP1305	A73PLUS		
FORD	NUEVA RANGER Diesel 4X4	2010	DIESEL 2.5	APC010	A14302PLUS	A7533SP	
FORD	RANGER RAPTOR	2021	2.0 LTS		PP16328		
FORD	RANGER TDCI	2013-2021	2.2 - 3,2 LTS	AP35892	PP16328	PP176AC	
FOTON	OLIN 2.2 TON CABINA SENCILLA	2010>	2.5 EURO III	AP2206	A2863SP	A4053SP	
FOTON	TUNLAND MECANICA	2012-2014	2.8 Diesel	AP35915	PP17356	PP19925	
FOTON	VIEW	2007-2011	2.2 Diesel	AP2217	A1SP	A4054SP	

MARCA	LÍNEA	AÑO	MOTOR	AIRE	ACEITE	COMBUSTIBLE	OTROS
FOTON	VIEW VANS CS2 -K1	2013>	CUMMINS ISF 129 HP 2,8 LTS		A4044		
FOTON	VIEW VANS CS2	2019>	CUMMINS ISF 129 HP 2,8 LTS		PP17356	AS200SP	
FOTON	VIEW VANS DIESEL	2016>	DIESEL 2,800 CC	AP8054	A2863SP	AS200SP	
FOTON	VIEW VANS DIESEL BJ483ZQB	2007-2010	DIESEL 2,200 CC	AP2217	A1SP	A4053SP	
FOTON	GRATOUR IX	2019>	1.5 LTS		A14616	P346P	
FOTON	TOANO	2018	CUMMINS ISF 2,8 LTS		PP17356	AS36268SP	
FOTON	CARGO BOX TM2	2020	QUANCHAI – 4A2-88C53 EURO IV				
GMC	TERRAIN	2018-2020	1.6 LTS	AP99727	PP85674		
GOLDEN DRAGON	VANS PANEL PASAJEROS	2007-2010	2,5 LTS 4 CIL	AP2217	A54SP	A1226LSP	
GOLDEN DRAGON	VANS PANEL PASAJEROS	2007-2010	2,5 LTS 4 CIL				
GOLDEN DRAGON	VANS PANEL PASAJEROS	2007-2010	2,5 LTS 4 CIL	AP8054	A4044	AS200SP / PM6630	
GREAT WALL	WINGLE 5 DIESEL	2017	2.0 LTS	AP31711	A329	A4054SP / AS200SP	
GREAT WALL	HOVER	2008	2,8 LTS	AP31711	A2863SP	AS200SP	AP31030
GREAT WALL	HAVAL H5	2014>	2.4 LTS	AP31923	A53PLUS		
GREAT WALL	WINGLE 7	2019-2022	2.0 LTS		A329	A4054SP / AS200SP	
GREAT WALL	WINGLE	2011	2.8 LTS	AP31711	A2863SP	AS200SP	
HYUNDAI	H1	2010-2013	2.4 LTS	AP3532	A28SP	AS201SP	
HYUNDAI	H100 PORTER-VANS	2005-2019	6M/T GLS 2AB 2.5 LTS	AP3532	A092SP	A3726SP / AK570SP	
HYUNDAI	H100 PORTER	2005-2007	L4 2.5	APH100	A092SP	A3726SP / AK570SP	
HYUNDAI	H-100 VANS	2003>	L4 2500	AP45020	A092SP	AK570SP	
HYUNDAI	H-100 VANS Diesel	1991-2002	L4 2500	AP101222K	A092SP	AK570SP	
HYUNDAI	H200 - 250 - 350	2000	DIESEL	APH100 / AP45020	A4731SP	A3726SP	
HYUNDAI	HYUNDAI H100	1980 -2017	HYUNDAI DIESEL	AP5H100	A092SP	AK570SP	
HYUNDAI	HYUNDAI GRACE VANS DIESEL	1991- 2002	HYUNDAI D4BA	AP4000	A092SP	AK570SP	
HYUNDAI	NEW SANTA FE DIESEL	2008-2013	2.2 LTS	AP31697	PP27401	AS200SP	
HYUNDAI	SANTA FE	2011-2013	2.0 LTS	AP31796	A53PLUS	AS202SP	AP31029
HYUNDAI	SANTA FE ADVANCE DIESEL	2013-2017	2.2 LTS	AP31920	PP2F000	AS200SP	AP31029
HYUNDAI	STAREX H1 - GRAND STAREX TQ VANS	2008-2022	2.5 lts	AP3107	A28SP	AS201SP	AP31006
HYUNDAI	STAREX H1 Diesel	2005-2008	2.6 LTS	AP4001	A28SP	AK570SP	
HYUNDAI	TERRACAN	2006	2.5 Lt	AP31652	A28SP		

MARCA	LÍNEA	AÑO	MOTOR	AIRE	ACEITE	COMBUSTIBLE	OTROS
HYUNDAI	TERRACAN 2.5 TDI	2004-2007	2.5 LTS	AP31652	A092SP		
HYUNDAI	TUCSON Diesel	2004-2010	2.0 LTS	AP3108	A178PLUS	AS200SP	AP31739
HYUNDAI	TUCSON IX 35 Diesel	2014	2.4 LTS	AP3145	PP2F000	AS200SP	
HYUNDAI	TUCSON IX 35 Diesel	2014	2.4 LTS	AP31985	A53PLUS		AP31739
HYUNDAI	VERACRUZ	2007-2013	3.0 LTS		PP57061	AS202SP	
IVECO	49.12 - 50.12 BUS, CAMION DAILY	2003	49.12 - 50.12 BUS, CAMION	AP8280	A232SP	P346P / A243004DSP	
IVECO	DAILY 50C16 EURO V	2014>	3.0 LTS	AP8280			
IVECO	DAILY 70C17 EURO V	2019	FPT F1CE044 2.998 cc				
IVECO	35,10 FURGON RS - DAILY	2006	DIESEL	AP8280	A232SP	A243004DSP	
IVECO	DAILY A36-13 EURO III	2012>	3,0 LTS		A232SP	A1217 / AS200SP	
IVECO	DAILY TURBO 619-697	N/D	DAILY TURBO	AP1908233	A232SP	A243004DSP	
JAC	JAC JOYLONG	2015>	Cumm ISF 2.8 LTS	AP8054	PP17356	A243004SP / AS36209SP	
JAC	JAC REFINE	2012>	DIESEL	AP4001	A12	AS1282SP / AS200SP	
JAC	JAC T8	2020-2022	2,0 LTS			AS47103SP	AP31071
JAC	JAC T6	2019	1,9 LTS / 2,0 LTS			AS201SP (2)	AP31071
JAC	T8 2.0 diesel	2020-2022	2,0 DIESEL			AS201SP	AP31071
JAC	SUNRAY DIESEL EIII	2014-2017	2.7 LTS	AP311007	A2863B		
JIMBEI	H1	2007-2016	2,5 CC DIESEL	AP2217	A48SP	AS200SP	
JIMBEI	H2	2011-2016	2,8 CC DIESEL				
JIMBEI	H2L	2017	DIESEL 2.8 LTS	AP8054 / AP54100	A2863SP	AS200SP	
JIMBEI	HAISE	2011	DIESEL CRDI 2.5 LTS	AP8054	A14302PLUS	AS200SP	
KIA	BUSES KIA BESTA.	1993-1997	2.2 LTS	AP8551	A4046 / A4052SP	AK570SP	
KIA	CARNIVAL 2,9 LS Diesel MEC 9P	2001	2.9 Lt		A28SP	A093SP	
KIA	CARNIVAL 2,9 RS 7P	2003-2009	2.9 Lt	AP3603	A28SP	AK570SP	
KIA	GRAND CARNIVAL	2006-2013	2.9 LTS	AP3122	A092SP	PFG391	
KIA	GRAND PREGIO	2003-2004	2.9 LTS	AP240	A28SP	AK570SP	
KIA	GRAND PREGIO	2003-2004	2.9 LTS	AP240	A092SP	AK570SP	
KIA	GRAND PREGIO TURBO	2011-2014	3.0 LTS	AP240	A092SP	AK570SP	
KIA	K 2500TCI	2008-2014	2.5 LTS		A092SP	AK570SP	
KIA	K 2700 / K3000	2010-2019	2.7Lt / 3.0 LTS	AP2959	A28SP	AK570SP	
KIA	K2700	2011-2014	2.7 LTS	APH100	A28SP	AK570SP	
KIA	K2700- K3000	1995-2003	2.7 Y 3.0 LTS	AP233	A350	A093SP	
KIA	K3000S	2006	3.0Lt	AP2959	A28SP	AK570SP	
KIA	K3500S - K3600	2010- 2018	3.5 LTS / 3.6 LTS DIESEL OHV	AP3600	A350 CONFIRMAR	A3726SP / AK570SP	

MARCA	LÍNEA	AÑO	MOTOR	AIRE	ACEITE	COMBUSTIBLE	OTROS
KIA	KIA BESTA 2.7.	1993-1997	KIA 2,7 LTS	AP2561	A7028SP	A093SP	
KIA	KIA CERES MICROBUS Y CAMION.	1992-1996	KIA	AP2941	A091AE	AK570SP	
KIA	KIA GRAN PREGIO DIESEL	2002-2004	3.2 LTS	AP233	A7028SP	AK570SP	
KIA	PREGIO DIESEL	1995-2003	K3000 DIESEL	AP233	A350	A093SP	
KIA	PREGIO 2,7 VAN	2010-2016	2.7 LTS	AP2959	A28SP	A093SP	
KIA	PREGIO K3000 VAN	2016-2010	3.0 LTS	AP2959	A28SP	A093SP	
KIA	SEDONA	2010>	2.9	AP3122	A092SP	PFG391	AP31012
KIA	SORENTO	2002-2009	2.5 LTS	AP3112	A28SP	AS202SP	
KIA	SORENTO Diesel	2004-2009	2.0 LTS	AP3112	A092SP	AS200SP	
KIA	SORENTO Diesel	2004-2009	2.0 LTS		PP57061		AP31012
KIA	SORENTO Diesel AUT	2010-2011	2.5 LTS	AP3112	A28SP	AS200SP	AP31012
KIA	SORENTO TRUST	2014-2015	2.2 LTS	AP31900	PP2F000		AP31012
KIA	SPORTAGE	2005-2008	2.0 LTS	AP3108	A178PLUS	AS200SP	AP31012
KIA	SPORTAGE	2005-2008	2.0 LTS	AP31985	A53PLUS		AP43100
KIA	SPORTAGE 4X4 TURBO Diesel	2001-2004	2.0lt		A73PLUS	A3726SP / A093DSP	
KIA	SPORTAGE REVOLUTION Diesel	2010-2015	2.5 lts	AP3145	PP2F000	AS201SP	
KIA	TRADE 3500-TURBO Diesel	2004	3.500 cc	AP3600	A092SP	A093SP	
KIA	SPORTAGE	2017-2021	2.0 LTS	AP31980	A53PLUS	AS201SP	
KIA	SPORTAGE HIBRIDO	2020-2021	1.6 LTS	AP31985	A53PLUS	AS201SP	AP43100
MAHINDRA	KUV100	2019-2021	1,2 LTS		A4044		
MAHINDRA	PICK UP	2018-2022	2,2 LTS				
MAHINDRA	XUV500 TURBO 4X4	2013-2015	2,2 LTS		A4044	AS200SP	
MAHINDRA	SCORPIUS PICK UP	2011-2016	2.2Turbo Diesel	AP35917	A4044	P346P / AS200SP	
MAZDA	BT 50	2008-2013	WLAT 2.5 Diesel	APC010	A14302PLUS	A7533SP / A7533DSP	
MAZDA	BT 50 Diesel	2013-2017	2.2 / 3.2	AP35892	PP16328	PP176AC	
MAZDA	MAZDA 323 DIESEL	1998>	DIESEL	AP1350	A28SP	A3726SP / P346P	
MERCEDES BENZ	E320	2004-2006	3.2 LTS		PP7212		
MERCEDES BENZ	MB-140 VANS	2000	VARIOS		PP7196		
MERCEDES BENZ	SPRINTER 310 DIESEL	2001-2007	DIESEL 310	AP3570	PP7196	PP201030	AP31001
MERCEDES BENZ	SPRINTER 313 VAN PANEL	2001-2007	DIESEL 313	AP3570	PP71811	PP201030	AP31001
MERCEDES BENZ	SPRINTER 313 Y 413 ELECTRONICA	2002-2014	OM 611	AP3570	PP7181	PP808010	AP31001
MERCEDES BENZ	SPRINTER 412 DIESEL	2001-2007	OM 611	AP3570	PP7196	PP201030	AP31001
MERCEDES BENZ	SPRINTER 413 VAN PANEL	2002-2007	OM 611	AP3570	PP71811	PP201030	AP31001
MERCEDES BENZ	SPRINTER 415 CDI	2007-2016	DIESEL 2,2 CDI	AP35756	PP7181	PFG469	AP31084

GUIA LIVIANO DIÉSEL

MARCA	LÍNEA	AÑO	MOTOR	AIRE	ACEITE	COMBUSTIBLE	OTROS
MERCEDES BENZ	SPRINTER 515	2013-2015	DIESEL 3.0	AP35756	PP7181	PFG469	AP31084
MERCEDES BENZ	SPRINTER 416	2020-2021	2.2 LTS	AP35756	PP7181	PFG469	
MERCEDES BENZ	SPRINTER 516	2020-2021	OM651LA 2.1 LTS 163 HP	AP35756	PP7181	PFG469	
MERCEDES BENZ	SPRINTER 515 CDI	2007-2016	DIESEL 2,2 CDI	AP35756	PP7181		
MERCEDES BENZ	VITO II 113 CDI	2010-2015	DI 2.2		PP71811	PFG469	
MERCEDES BENZ	VITO III 114 CDI	2015-2018	DI 2.2		PP71811	PFG469	
MITSUBISHI	L200 Y NATIVA Diesel	2006-2009	2.5 Lt	AP3193	A28SP	AK570SP	
MITSUBISHI	L300	1991-2007	2.5 DIESEL	AP101222K	A28SP	AK570SP	
MITSUBISHI	NATIVA	2010-2015	2.5 Diesel	AP3115	A28SP	A7533SP / A7533DSP	
MITSUBISHI	NATIVA	2010-2015	2.5 Diesel	AP3115	A092SP	A7533SP / A7533DSP	
MITSUBISHI	NATIVA	2010-2015	2.5 Diesel	AP3193	A28SP	AK570SP	
MITSUBISHI	SPORTERO L200	2012-2018	2.5 Diesel	AP3115	A28SP	PP7355 / AK570SP	
MITSUBISHI	MONTERO SPORT	2019-2023	2.5 LTS	AP35898	A1402PLUS	PP7355/ PP201010	
MITSUBISHI	L200 SPORTERO	2019-2022	2.5 LTS	AP35898	A1402PLUS	PP7355	
MITSUBISHI	SPORTERO L200	2007-2011	4D56 2.5 Diesel	AP3193	A28SP	AK570SP	
MITSUBISHI	MONTERO SPORT 4X4 AUT DIÉSEL	2020>	2.5 LTS	AP3115	A28SP	A7533SP	
NISSAN	CABSTAR NT400	2009-2018	3.0 Diesel	AP3270	PP2200	A7533SP / A7533DSP / A5368SP	
NISSAN	FRONTIER D22 4X4	2004-2012	3.0 Lts TURBO	AP9S001	PP2200	A7614SP / AS1282SP / ASV1282SP / A5368SP	AP31060
NISSAN	FRONTIER	2004-2012	2.5 Lts Diesel	AP9S001	PP2200C	A7614SP / AS1282SP / ASV1282SP / A5368SP	AP31060
NISSAN	FRONTIER D22	2008-2017	3.0 LTS	AP9S001	A20PLUS	A7614SP / AS1282SP / ASV1282SP / A7533SP	AP31060
NISSAN	FRONTIER NP300	2008-2015	2.5 Diesel	AP9S001	A20PLUS	A7614SP / AS1282SP / ASV1282SP / A7533SP	AP31060
NISSAN	FRONTIER NP300	2008-2015	2.5 Diesel	AP35961	A20PLUS	PP80472	AP31123
NISSAN	MT3000	2009-2014	V6 3.0 LTS TURBO DIESEL	APG4800	PP2200	A7533SP / A7533DSP / A5368SP	
NISSAN	NAVARA D22	2009-2014	TD27 2.5 Diesel	AP3127	A20PLUS	A7533SP / A7533DSP / A5368SP	AP31060

GUIA LIVIANO DIÉSEL

MARCA	LÍNEA	AÑO	MOTOR	AIRE	ACEITE	COMBUSTIBLE	OTROS
NISSAN	NAVARA PICK UP 2,7 Diesel	2009-2010	2.7 Lt	AP3127	A20	A7533SP / A7533DSP / A5368SP	AP31060
NISSAN	MAXIMA	1995-2003	3.0 LTS	AP1312	A1402		AP31060
NISSAN	PATHFINDER 2.5 TDI	2006-2008	2.5 LTS	AP35594	A20	A7533SP / A7533DSP / A5368SP	
NISSAN	PATROL	2006-2014	3.0 Diesel		PP2200	AS1282SP / ASV1282SP / A7533SP	
NISSAN	TRADE	1996-2001	TRADE	APG4800	A1SP	A7533SP / A7533DSP	
NISSAN	URVAN	2007-2015	2.5 LTS	AP101222K	PP2200C	A7533SP / A7533DSP	AP43100
NISSAN	URVAN	2007-2015	2.5 LTS	AP101222K	PP2200	A7533SP / A7533DSP / AS1282SP	AP43100
NISSAN	URVAN Diesel	2002-2005	L4 3.0	AP3193	PP2200C	A7533SP / A7533DSP	
NISSAN	URVAN	2007-2015	2.5 LTS	AP101222K	A20PLUS	PFG448 / AS1282SP / ASV1282SP	AP43100
NISSAN	URVAN Diesel	2002-2005	L4 3.0	AP3270	PP2200	AS1282SP / ASV1282SP / A7533SP	AP43100
NISSAN	URVAN NV350	2015-2022	TD25DDTI 2.5 LTS 127 HP	AP101222K	A20PLUS	PFG448 / AS1282SP / ASV1282SP	AP43100
PEUGEOT	5008	2019-2021	2.0 LTS		A1402PLUS		
PEUGEOT	BOXER III	2006-2011	3.0 LTS HDi 160/HDi FAP, FAP 180 Euro 5	AP31874			
PEUGEOT	BOXER III	2006-2011	3.0 LTS HDi 160/HDi FAP, FAP 180 Euro 5	AP31874			
PEUGEOT	BOXER III	2006-2011	3.0 LTS HDi 160/HDi FAP, FAP 180 Euro 5	AP31874			
PEUGEOT	MANAGER	2012-2016	2.2 LTS L4 2.2L 2198cc	AP31874			
PEUGEOT	MANAGER	2012-2016	2.2 LTS L4 2.2L 2198cc	AP31874			
RAM	PROMASTER 1500	2014-2018	3.0 LTS L4 3.0L 2998cc 183 CID	AP31874			
RAM	PROMASTER 2500	2014-2017	3.0 LTS L4 3.0L 2998cc 183 CID	AP31874			
RAM	PROMASTER 2500	2014-2017	6.7 LTS		A339SP		
RAM	PROMASTER 3500	2014-2017	3.0 LTS L4 3.0L 2998cc 183 CID	AP31874			

MARCA	LÍNEA	AÑO	MOTOR	AIRE	ACEITE	COMBUSTIBLE	OTROS
RENAULT	ALASKAN	2017-2020	2,5 LTS	AP35961	A20PLUS	PP80472	AP31123
RENAULT	KOLEOS	2009-2014	2.0 Diesel	AP35750	PP62442		
RENAULT	MASTER IV	2013-2021	2.3Lts, 130HP, M9T Euro 5/6	AP31963	PP62442	PP80468	
RENAULT	MASTER III	2012-2015	2.5 Diesel	AP35800	PP72321	PM4094	
RENAULT	TRAFIC I	2006-2008	2.0 LTS		PP62442	PM4094	
RENAULT	TRAFIC II	2012-2014	2.0 LTS		PP62442	PM4094	AP31101
RENAULT	TRAFIC II	2012-2014	2.0 LTS		PP62442	PM4094	AP31136
RENAULT	TRAFIC III	2015-2017	1.6 LTS	AP31976	PP62442	PP80468	AP31136
SEAT	ATECA TDI	2021-2023	2,0 LTS		EOM: 03N115562		
SSANGYONG	ACTYON	2008-2014	2.2 LTS	AP3599	PP40425	PFG422 / PFG391	AP31017
SSANGYONG	KORANDO	1996-1998	2.0 LTS	AP35590	PP7196		
SSANGYONG	KORANDO C	2011-2016	2.0 Diesel	AP31935	PP03009	PP7455 / PM6630	
SSANGYONG	KYRON	2006-2014	2.0 Diesel	AP3599	PP40425	PFG422 / PFG391 / PM6630	
SSANGYONG	REXTON RX	2004-2007	2.7 Diesel	AP35660	PP40425	PFG422 / PFG391 / PM6630	AP31017
SSANGYONG	REXTON RX	2004-2007	2.9 Diesel	AP35660	PP7196	PFG422 / PFG391	
SSANGYONG	RODIUS	2012>	2.0 Diesel	AP31935	PP03009	PP7455	
SSANGYONG	SSANYONG KORANDO DIESEL	2009>	DIESEL 2900 cc TURBO	AP35677	PP7196	A8401	
SSANGYONG	STAVIC	2004-2014	2.7 Diesel	AP3599	PP40425	PFG422 / PFG391 / PM6630	
TOYOTA	DAIHATSU ROCKY VENEZUELA	1982	DIESEL	AP3193	A4046	AK570SP	
TOYOTA	FORTUNER	2008-2014	3.0 Diesel	APC010	A14302PLUS	PP7355	AP31070
TOYOTA	FORTUNER 2.7	2017-2022	2,7 LTS	AP35977	A14302PLUS	PP7476	AP31138
TOYOTA	FORTUNER 2.7	2017-2022	2,7 LTS	APC010	A14302PLUS		
TOYOTA	HILUX DIESEL CAMMON RAIL	2017-2021	2,4 / 2.8 lts 2GD-FTV	AP35977	A14302PLUS	PP7476	AP31138
TOYOTA	HILUX DIESEL	2017-2021	2,8 LTS 1GD-FTV DIESEL	AP35977	A14302PLUS	PP7476	AP31138
TOYOTA	HILUX VIGO D4D - HIGH RIDER DIESEL	2006-2010	2.5 Diesel	APC010	A14302PLUS	PP7355	AP31071
TOYOTA	HILUX DIESEL	2006-2011	3.0 LTS	AP54180	A1SP	A7533SP	
TOYOTA	HILUX DIESEL	2006-2011	3.0 LTS	APC010	A14302PLUS	A7533SP	
TOYOTA	LAND CRUISER	1999-2008	DIESEL 3.0Lts	AP3134	A7029SP	A7533SP / A7533DSP	AP31071
TOYOTA	LAND CRUISER 200 IMPERIAL	2014-2021	4.5 LTS	AP31753	PP7406	PP7444	AP31071

MARCA	LÍNEA	AÑO	MOTOR	AIRE	ACEITE	COMBUSTIBLE	OTROS
TOYOTA	LAND CRUISER DIESEL	1990-1995	4.0 Lts Diesel	AP62636	A14302PLUS		
TOYOTA	Land Cruiser TXL turbodiesel de 3,0	1996 -2007	1KD-FTV	AP3134	A14302PLUS	A7533SP	AP31071
TOYOTA	LAND CRUISER PRADO D 4D	2010-2015	3.0 LTS	AP3134	A14302PLUS	A7533SP / A7533DSP	AP31071
TOYOTA	PRADO TX / VX	2010-2021	3.0 LTS	AP3134	A14302PLUS	A7533SP / A7533DSP	AP31071
TOYOTA	SAHARA	2018	4.5 LTS	AP31753	PP7406	PP7444	AP31071
TOYOTA	SAHARA Diesel	2009-2019	4,5 LTS DIESEL	AP31753	PP7406		
TOYOTA	SW4 XROAD/SRV DIESEL	2018>	2,8 LTS	AP35977	A14302PLUS	PP7476	AP31138
TOYOTA	TOYOTA PRADO	1999-2002	3.0 LTS	AP67030	A7029SP	AK570SP	
TOYOTA	TOYOTA CAMRY COROLLA	1985-1987	DIESEL		A91480		
TOYOTA	TOYOTA LAN CRUISER SAHARA 4,5	1990-1995	4,5 LTS	AP62636			
TOYOTA	TOYOTA RAV 4 2,2L DIESEL	2006-2010	2,2 LTS	AP31806			
TOYOTA	PRADO TX / TX-L	2010-2020	3.0 LTS	AP3134	A14302PLUS	A7533SP / A7533DSP	AP31071
VOLKSWAGEN	AMAROK	2016	2,0 TDI CNFB	AP35781	PP15562	PFG454 / PFG453	AP31631
VOLKSWAGEN	AMAROK	2016	2,0 TDI CNFB	AP35781	PP15562		AP31631
VOLKSWAGEN	CRAFTER 5.0	2011-2021	2.0 Diesel	AP35756	PP15562	PFG453	AP31084
VOLKSWAGEN	CRAFTER 5.0	2011-2021	2.0 Diesel	AP35756	PP5562	PFG453	AP31084
VOLKSWAGEN	TIGUAN II TDI ALLSPACE	2016>	2.0 Diesel				
VOLKSWAGEN	TIGUAN TDI	2008-2015	2.0 Diesel		A15403		
VOLKSWAGEN	TRANSPORTER T5	2009-2015	2.0 LTS	AP35758	PP15562		AP31631
VOLKSWAGEN	TRANSPORTER T5	2009-2015	2.0 LTS	AP35758	PP15466		
VOLKSWAGEN	VOLSKWAGEN MULTIVAN V	2001	2.0 Diesel	AP3564			
ZHAN-QI	CAMPEROS 2.720 c.c.	2013	BJ2024CJ12		A2863SP	A4053SP	



ES JUSTO
LO QUE NECESITAS



GUÍAS DE FILTRACIÓN - LIVIANO



CO-SC-CER896120

MARCA	LÍNEA	AÑO	MOTOR	AIRE	ACEITE	COMBUSTIBLE	OTROS
AUDI	A3 TFSI	2017-2018	2.0 LTS		PP6013Z		
AUDI	A4 TFSI	2012-2015	1.8 LTS		PP6013Z		
AUDI	A5 TFSI	2011-2017	1.8 LTS		PP6013Z		
AUDI	A5 TFSI	2011-2017	1.8 LTS		PP6013Z		
AUDI	TT TFSI	2015-2018	2.0 LTS		PP6013Z		
AUDI	Q5 TFSI	2010-2017	2.0 LTS		PP6013Z		
AUDI	Q3 TFSI	2019-2021	2.0 LTS		PP6013Z		
AUDI	A1 TFSI	2016-2018	1.4 LTS		A14302PLUS		
AUDI	A3 TFSI	2017-2018	2.0 LTS		A14302PLUS		
AUDI	Q7 TFSI	2010-2016	3.0 LTS				AP31631
AUDI	A4 TFSI	2012-2015	1.8 LTS				
AUDI	Q5 FSI	2010-2016	3.2 LTS				
BMW	BMW X3 , X5, X6	2004-2010	2.0 ; 3.0		PP1072		
BMW	BMW X3.X5.325	2011-2017	2,0 LTS		PP1053		
BMW	BMW X5 3.0 TDS	2000-2003	3.0 TDS		PP13376		
BMW	325i E30	1987-1995	325 I E30	AP35645	A178PLUS		
BMW	325i E36	1996-2004	325 I E36	AP35644		PFG1195	
BMW	BMW VARIOS	1990-2006	VARIOS		PP27908		
BMW	X3 X4 2.0	2017	2.0 LTS		PP1053		
BRILLANCE	BRILLANCE V5	2015-2018	V5 1600 cc	AP3108	A58PLUS		
BUICK	BUICK, CADILLAC, AMERICAN MOTO	1974	8 CILN. CARB	AP121	A33		
BYD	FLYER TAXI	2017	1.1 LTS	AP31628	A14476PLUS	PFG330	
BYD	F-ZERO	2010-2016	1.0 Lts		A14476PLUS		
BYD	MOVIL 3	2017>	1.5 LTS	AP31628	A1402PLUS	PFG330	
CARPATI	CAMPERO	1968-1969			PM18		
CHANA	BENNI CLASSIC; LUXURY	2007-2009	1.3 LTS	AP3588	A14476PLUS		
CHANA	CAMION STAR 1.012 c.c.	2007-2009	1.012 cc	AP3588	A14476PLUS		
CHANA	CAMIONETA STAR VAN SC 6350 C	2004-2008	1.0 LTS	AP3588	A14476PLUS		
CHANA	CAMIONETA STAR VAN SC 6390 B	2009-2010	1.3 LTS	AP3588	A14476PLUS		
CHANA	PICK UP STAR CABINA SENCILLA	2005-2009	1.0 LTS	AP3588	A14476PLUS		
CHANGAN	VANS	2012	1,5 LTS		A58PLUS	PFG25121074	
CHENGDU	JX 0810 CAMIONES PEQ. 409	2006	VARIOS		A810		
CHENGDU	JX 0812	2006	VARIOS		A812		
CHERY	AIRE CHERY TIGGO 2.0 MPI	2015> 2021	2.0 LTS	AP31861	A2863SP	PFG25121074	
CHERY	AIRE CHERY TIGGO 2.0 MPI	2015> 2021	2.0 LTS	AP31930	A2863SP	PFG25121074	
CHERY	ARAUCA	2011-2014	1,3 LTS	AP311032	A18PLUS	PFG25121074	
CHERY	CHERY TIGGO T7	2019-2022	1,5 LTS			PFG25121074	

MARCA	LÍNEA	AÑO	MOTOR	AIRE	ACEITE	COMBUSTIBLE	OTROS
CHERY	CHERY TIGGO A13	2018-2022	1,5 LTS		A14302PLUS		
CHERY	CHERY ARRIZO	2018-2022	1,5 LTS		A14302PLUS	PFG25121074	
CHERY	CHERY TIGGO T2	2018-2022	1,5 LTS		A14302PLUS	PFG25121074	
CHERY	CHERY TIGGO T3	2015-2021	1.6Lts	AP311036	PP12010	PFG25121074	
CHERY	FULWIN II	2016-2019	1,5 LTS		A14302PLUS		
CHERY	GRAN TIGGO T5	2017-2020	2.0 LTS	AP31990	PP12010	PFG25121074	
CHERY	NICE	2011	1,3 LTS		A223	PFG25121074	
CHERY	Q.Q. 6	2015>	1,3 LTS		A18 / A14302PLUS	PFG25121074	
CHERY	QQ3	2006-2015	0,8 Lts	AP4494	A14476		
CHERY	QQ3	2006-2015	1.0 Lts	AP311035	A14476	PFG25121074	
CHERY	QQ3	2006-2015	1,1 Lts	AP4494	A14476	PFG25121074	
CHERY	TIGGO CAMIONETA 16V GASOLINA	2011-2013	1.6Lts	AP31861	A73PLUS		
CHERY	VAN PASS CARGO	2011-2015	1.Lts	AP35862	A14476PLUS		
CHERY	VAN Y380 CARGO	2013>	1.2 4 CIL 16 VL		A14476PLUS		
CHERY	X 1	2011-2014	1,3 LTS	AP311032	A18PLUS	PFG25121074	
CHERY	XCROSS X1	2015-2017	1,5 LTS		A18PLUS		
CHERY	XCROSS	2011-2014	1,3 LTS	AP311032	A18PLUS	PFG25121074	
CHERY	YOKI PICK UP	2014-2018	1,1 Lts		A14476	PFG25121074	
CHEVROLET	TRAIL BLAZER	2013-2022	3.6 CC	AP48772		PFG25121074	
CHEVROLET	BLAZER / TRAMVERSE	2018-2021	3.6 LTS		A160PLUS		AP31032
CHEVROLET	CHEVROLET VITARA	1996-1998	4 CIL FI	AP31511	A14476		
CHEVROLET	ALTO, ESPECIAL EDITION	1994-2004	L4 1.0	AP3181	A14476PLUS		
CHEVROLET	ASTRA MEC 4P	2004>	2.0 Lt	AP3513	A111		
CHEVROLET	ASTRA, SEDAN y CONFORT	2001-2008	L4 1.8/2.0 Lt	AP3513	A43S		
CHEVROLET	AVEO 1.6 4P A.	2010-2013	1.6 LTS	AP3196	A9797PLUS	PFG25121074	AP71191 / AP39649
CHEVROLET	AVEO EMOTION GTI	2010-2012	1.6 LTS	AP3196	A9797PLUS	PFG25121074	AP39649 / AP31028
CHEVROLET	AVEO FAMILY 4P 1.5 Y A.A. Y ESPECIAL	2004-2014	1.4 y 1.5 LTS	AP3196	A9797PLUS	PFG25121074	AP39649
CHEVROLET	BEAT	2018>	1,2 LTS	AP3146	A14616PLUS	PFG25121074	AP71191
CHEVROLET	BLAZER 2000	2000	V6 4.3	AP1339	A4011	PFG481I	
CHEVROLET	BLAZER 2000	2000	8 CILIND. INY	AP121	A11	PFG481I	
CHEVROLET	CAPTIVA 3.2 V6	2010	3.2 LTS	AP3190	A160PLUS		AP40878
CHEVROLET	CAPTIVA AUTOMATICA	2017	3.2 V6	AP3190	A1432		AP40878
CHEVROLET	TRAX	2013-2021	1.4 LTS	AP356020	PP85674		AP71191
CHEVROLET	CAPTIVA SPORT	2012-2014	2.4 LTS	AP3191	PP8088		AP31029
CHEVROLET	CAPTIVA SPORT 2.4 y 3.0	2010-2012	2.4 Y 3.0 LTS	AP3191	A160PLUS		AP40878

MARCA	LÍNEA	AÑO	MOTOR	AIRE	ACEITE	COMBUSTIBLE	OTROS
CHEVROLET	CAPTIVA TURBO	2019-2022	1,5 Lt		A160PLUS		
CHEVROLET	CAPTIVA 2,4 3.0 SPORT	2016	2.4 Y 3.0 LTS	AP3191	PP8088		AP31029
CHEVROLET	CARNIVAL MEC./AUT ./Z-24 / CAVALIER	1992	V6 2,8L		A111		
CHEVROLET	CARRY VAN CARGA, PASAJEROS	1996-1998	SUZUKI	AP410	A18PLUS		
CHEVROLET	CHEVETTE TAXI 1600	1980-1999	2BBL 1,6L	AP147	A111	PFG516K	
CHEVROLET	CHEVROLET : LUV 2300, CAMPERO	1989-1997	L4 2,3	AP2300	A323	PFG516K	
CHEVROLET	CHEVROLET CHEVETTE. FIAT 131FL	1982	1.3 LTS	AP127	A111	PFG516K	
CHEVROLET	CHEVROLET CORSA EVOLUTION	2003-2008	GL 1,4L	APC301251	A111		
CHEVROLET	CHEVROLET LUV 2200 (TFR)	1997	V6-3200	AP3170	A323	PFG323	
CHEVROLET	CHEVROLET LUV - ISUZU	1985	L4 1,6	AP126	A4044	PFG516K	
CHEVROLET	CHEVROLET MONZA TODOS. DAEWOO	1982-1992	4 CIL CARB	AP132	A111	PFG516K	
CHEVROLET	CHEVROLET RODEO LUV 2300	1998	2.6 LTS	AP3179	A323		
CHEVROLET	CHEVROLET SAMURAI, SUZUKI SJ-4	1986-1992	L4 1,3	AP142	A4050	PFG516K	
CHEVROLET	CHEVROLET SPRINT.	1987-1997	4 CILIN CARB,	AP4337	A223	PFG516K	
CHEVROLET	CHEVROLET VITARA 3 PUERTAS P.O.	1993	1.6 LTS	AP3178 / AP3195	A4050		
CHEVROLET	CHEVROLET VITARA 5PUERTAS P.O.	1992	1.6 LTS	AP3178 / AP3195	A14476		
CHEVROLET	CHEVY C2	2005-2009	1.6 LTS	AP1298	A111 / A43S		
CHEVROLET	CHEVY TAXI 98	1998-2001	L4 1.3	AP561	A18PLUS	PFG516K	
CHEVROLET	CHEYENNE	1993-1999	3.5 LTS	AP3707	A11	PFG481I	
CHEVROLET	COBALT	2012	1.8MT LT.LTZ	AP350990	A111 / A43S	PFG25121074	
CHEVROLET	COBALT SEDÁN LT, LTZ Y AUT	2013-2017	1.8 LTS	AP350990	PP85674	PFG330	AP71191
CHEVROLET	CORSA ACTIVE	2004-2007	L4 1.4 LTS	AP1298	A111 / A43S		
CHEVROLET	CORSA EVOLUTION	2003-2007	L4 1.4 y 1.8 LTS	APC301251	A111 / A43S	PFG25121074	
CHEVROLET	CORSA GASOLINA WIND, GL, GLS, L 5P	1996-2007	L4 1.3 y 1.4 LTS	AP1298	A111 / A43S		
CHEVROLET	CORSA POWER TAXI	2003-2006	L4 1.6	AP1298	A111		
CHEVROLET	CORSA WIN, GL 02	2002-2005	L4 1.4 LTS	AP1298	A111 / A43S		
CHEVROLET	CRUZE	2017>	1.4 LTS		A160PLUS		AP31029

MARCA	LÍNEA	AÑO	MOTOR	AIRE	ACEITE	COMBUSTIBLE	OTROS
CHEVROLET	CRUZE LIMITED 4,8	2010-2016	1.4 Lt Y 1.8 LTS	AP3537	PP85674		AP71191
CHEVROLET	ELITE	2014-2017	1.8 LTS	AP350990	PP85674		
CHEVROLET	EPICA 2.0	2003-2005	2.0 Lt		A111		
CHEVROLET	EPICA 2.5	2003-2005	2.0/2.5 LTS		A111		
CHEVROLET	EPICA Mec y automat	2003-2017	2.0 y 2.5 Lt	AP3450	A111 / A43S		
CHEVROLET	EPICA TIPTRONIC	2009-2012	2.5 Lt	AP3450	A111 / A43S		
CHEVROLET	EQUINOX LTZ AUT	2018-2021	1,5 LTS	AP99727	A160PLUS		AP31029
CHEVROLET	ESTEEM	2000-2008	1.3 Y 1.6	AP3176	A18PLUS		
CHEVROLET	SWIFT TWINCAM	1997	1,3 INY	AP3119	A14476		
CHEVROLET	GRAN VITARA	2002	1.6 LTS	AP3195	A1406	PFG368	
CHEVROLET	GRAND VITARA XLT	2008	2.7 LTS	AP31828	A18PLUS		AP31026
CHEVROLET	GRAND VITARA 4P	2004	2.5 Lt	AP3195	A4050PLUS		
CHEVROLET	GRAND VITARA SZ	2010-2015	2.0 y 2.5 Lt	AP3117	A1406PLUS		
CHEVROLET	GRAND VITARA SZ	2010-2015	2.7 LTS	AP31828	A18PLUS		AP31026
CHEVROLET	GRAND VITARA V6	2000-2006	1.6 Lt	AP3195	A1406PLUS		
CHEVROLET	GRAND VITARA XL7	2007	2.7 Lt	AP3195	A18PLUS		
CHEVROLET	HHR 2.4	2009>	2.4 LTS	AP3571	PP8088		
CHEVROLET	JIMNY	1998.2008	L4 1.3 LTS	AP31551	A1406PLUS	PFG25121074	
CHEVROLET	JIMNY 4CIL INY JEEPS	1998-2002	4CIL	AP3181	A14476PLUS / A18PLUS		
CHEVROLET	LUV 2200	2000-2004	2.2 Lt, 2.6 Lt	AP3170	A111		
CHEVROLET	LUV D-MAX GASOLINA 4X4	2005-2010	3.5 V6	AP3143	A52 / A73PLUS	PFG330	AP31030
CHEVROLET	LUV D-MAX GASOLINA	2005-2010	2.4 LTS	AP3143	A111	PFG330	AP31030
CHEVROLET	LUV D-MAX GASOLINA	2005-2010	2.4 LTS	AP3143	A111	PFG330	
CHEVROLET	LUV D-MAX GASOLINA	2005-2010	2.4 LTS	AP3143	A111	PFG330	
CHEVROLET	N200 CARGO Y PASAJEROS	2010-2014	1.2 LTS	AP3514	A14616PLUS	PFG25121074	
CHEVROLET	N300 1.2 CARG	2016>	1.2 LTS	AP3514	A14616PLUS	PFG25121074	
CHEVROLET	N400	2022	1.5 LTS				
CHEVROLET	JOY	2021	1.4 LTS	AP31960	A9797PLUS	PFG25121074	AP71191
CHEVROLET	N300 1.2 CARG	2016>	1.2 LTS		A14616PLUS	PFG25121074	
CHEVROLET	ONIX	2021>	1.0 CC TURBO		A160PLUS	PFG25121074	
CHEVROLET	ONIX NB - HB	2016-2020	1,4 LTS	AP35960	A9797PLUS	PFG25121074	AP71191
CHEVROLET	OPTRA ADVANCE, HB, Mec y Aut	2004-2014	1.6 y 1.8 Lt	AP3450	A9797PLUS	PFG25121074	AP31002
CHEVROLET	OPTRA, HB mec, aut	2004-2008	1.4 LTS	AP3450	A9797PLUS	PFG25121074	AP31002
CHEVROLET	ORLANDO	2013-2016	2.4 LTS		PP8088		AP71191
CHEVROLET	CHEVY TAXI PLUS	2020-2022	1.2 LTS	AP3146	A14616PLUS		AP71191
CHEVROLET	CHEVY TAXI PREMIUM SAIL	2012-2022	1.4 LTS	AP351833	A14616PLUS	PFG460	AP31032

MARCA	LÍNEA	AÑO	MOTOR	AIRE	ACEITE	COMBUSTIBLE	OTROS
CHEVROLET	SAIL	2012-2018	1.4 LTS	AP351833	A14616PLUS	PFG460	AP31032
CHEVROLET	SONIC	2012-2017	1.4 Y 1.8 LTS	AP350990	PP85674	PFG330	AP71191
CHEVROLET	SPARK 7-24	2004-2005	L3 1.0	AP4494	A14476PLUS	PFG25121074	
CHEVROLET	SPARK GT	2011-2017	L3 1.2	AP3146	A14616PLUS	PFG25121074	AP31019
CHEVROLET	SPARK LS, GO CHRONOS	2016-2017	L3 1.0	AP4495	A14476PLUS	PFG25121074	AP25700
CHEVROLET	SPART LIFE	2016	VARIOS	AP4495	A14476PLUS	PFG25121074	
CHEVROLET	SPRINT FI 98	1998-2004	L3 1.0	AP561	A18PLUS		
CHEVROLET	SWIFT	2013-2016	1.2 LTS	AP531	A18		
CHEVROLET	SWIFT	2013-2016	1.2 LTS	AP561	A18		
CHEVROLET	SWIFT CHEVYTAXI	1999-2004	1.6 LTS	AP531	A18		
CHEVROLET	TAHOE	2007-2020	5300 CC		A160 / A160PLUS		
CHEVROLET	TAXI Sprint 1.0	1994-1998	L3 1,0	AP531	A18		
CHEVROLET	TRACKER	2013-2019	1.8 CC	AP356020	PP85674		AP71191
CHEVROLET	TRACKER TURBO	2021>	1.2 CC TURBO		A160PLUS	PFG25121074	
CHEVROLET	TRACKER	2013-2019	1.8 CC	AP356020	PP95785		
CHEVROLET	TRAIL BLAZER	2013-2022	2,8 CC DIESEL	AP35433	A1432		
CHEVROLET	BLAZER / TRAVERSE	2018-2021	3.6 LTS		A160PLUS		
CHEVROLET	TRAVERSE	2015-2017	3.6 LTS	AP31942	A52041SP		AP31032
CHEVROLET	ZAFIRA	2002-2004	L4 2.0	AP3513	A111	PFG25121074	
CHEVROLET	ZAFIRA	2002-2004	L4 2.0	AP3513	A111		
CHEVROLET	SAIL 3	2018>	1,5 Lts	AP99322	A14616PLUS		
CHEVROLET	CHEVROLET CAVALIER	1992>	2.6 LTS	AP3924	A111	PFG4811	
CITROEN	BERLINGO MULT	2002-2007	1.9 Lt		PP4780	PFG330	
CITROEN	C3 SEDUCTION	2011-2015	1.4 LTS	AP35941	PP4780		
CITROEN	C3	2020-2023	1.2 LTS		A1402PLUS	PFG330	
CITROEN	C4 SEDAN	2011-2015	1.6 LTS	AP35941	PP358		
CITROEN	C4 CAPTUS	2018-2023	1.6 LTS	AP35941	A4056	PFG330	
CITROEN	C4 CAPTUS T	2019-2023	1.6 LTS		PP358	PFG330	
CITROEN	DS4 CROSSBACK	2012-2018	1.6 LTS		PP358		
CITROEN	DS5 CROSSBACK	2013-2018	1.6 LTS		PP358		
CITROEN	DS3 CROSSBACK	2017-2023	1.2 LTS		A4056		
CITROEN	DS7 CROSSBACK	2019-2023	1.6 LTS		PP358		
CITROEN	C5 T	2019-2023	1.6 LTS		PP358		
CITROEN	C5 2,0 y 3.0 AUT, MEC F.E	2003	L4 2.0 - 3.0 Lt	AP3517	A4056		
CITROEN	C-ELYSEE	2013-2016	1.6 LTS	AP35941	PP358		
CITROEN	CITROEN C2 - C3	2006	1,4 LTS	AP35843	PP4780		
CITROEN	CITROEN ZX, XANTIA	2002	1,8 LTS INY		A4056		
CITROEN	JUMPER	1995	4 CIL. INYC.		A1402		

MARCA	LÍNEA	AÑO	MOTOR	AIRE	ACEITE	COMBUSTIBLE	OTROS
CITROEN	XSARA 1,6 SX	1998-2004	L4 1.6 Lt	AP3567	A4056	PFG330	
CITROEN	XSARA SX 2,0 F.E	1998-2003	L4 2.0 Lt	AP3567	A4056	PFG330	
DACIA	NOVA TAXI	2002-2003	1.4 LTS	AP0978	AR1218		
DAEWOO	DAEWOO NUBIRA 2.0 16V	1998-2002	1,6 ; 2.0	AP31542	A111	PFG25121074	
DAEWOO	TOWNER, DAEWOO DAMAS	1998-2002	ASIA MOTORS	AP3579			
DAEWOO	CIELO, RACER GTI, STI 93	1993-1996	L4 1.5	AP1347	A9797PLUS	PFG481I	
DAEWOO	DAEWOO LANOS	1997-2003	L4 1,5	AP3563	A111	PFG25121074	
DAEWOO	DAEWOO TICO	1997-2001	L4 0,8	AP537	A18	PFG481I	
DAEWOO	LABO	1998-2004	0.8 Lts	AP410	A18		
DAEWOO	LANOS	1997-2002	1.3 Lt	AP3563	A111	PFG25121074	
DAEWOO	MATIZ	2000-2003	0.8	AP4494	A14476PLUS	PFG25121074	
DAEWOO	TACUMA	2001-2003	1.8 Lt		A111	PFG330	
DAIHATSU	CHARADE	1999-2000	L3 1.0		A14476PLUS		
DAIHATSU	CHARADE	1999-2000	L3 1.0	AP31550	A14476PLUS		
DAIHATSU	DAIHATSU CHARADE F.I.	1996-1999	1.6 LTS	AP31550	A1406PLUS		
DAIHATSU	F. AIRE DAIHATSU TERIOS	1999	1.3 LTS	AP3114	A14476PLUS	PFG405	
DAIHATSU	FEROZA CARBURADO	1995-2000	1.6 LTS	AP51557	A18	PFG516K	
DAIHATSU	GRAN MOVE	1997-2003	1.6 Lts	AP31550	A14476PLUS / A1406PLUS		
DAIHATSU	NEW SIRION GTI MEC	2013	1.3 y 1.5	AP31643	A14476PLUS		
DAIHATSU	SIRION II	2007-2013	1.3 Y 1.5	AP31643	PP4024		
DAIHATSU	TERIOS 1,3	1998	1.3 LTS	AP3142	A14476PLUS	PFG405	
DAIHATSU	TERIOS CAMPERO OK II PLUS, SPORT	2007-2016	L4 1.5 LTS	AP3113	A14476PLUS		
DAIHATSU	TERIOS II	1999-2005	VARIOS	AP3514	A14476PLUS		
DAIHATSU	TERIOS OK II	2007-2014	1.5 LTS	AP3113	A14476PLUS		
DAIHATSU	TERIOS OKKI ESTANDAR	2006-2010	L4 1.5	AP3113	A14476PLUS		
DAIHATSU	YRV	1999-2008	1.3 LTS	AP31643	A14476PLUS		
DFSK	GLORY 580	2017- 2020	1.5 LTS		AR9	PFG25121074	
DFSK	GLORY 580	2017- 2022	1.8 LTS		A14476	PFG25121074	
DFSK	C37 MINI VANS	2017	1.3 LTS				
DFSK	S30	2017	1.6 LTS				
DFSK	VANS PASAJEROS / CARGO	2014	1.1. Y 1.3 LTS	AP3588	A14476PLUS / A1406		
DODGE	CHRYSLER, AUTOS Y CAMIONES DOD	1974	CHRYSLER, AUTOS		A1SP		
DODGE	DODGE TAXIS	1960-1965	DODGE TAXIS		PM210		
DODGE	DURANGO	2015-2021	5.7 LTS	AP35898	A160PLUS		
DODGE	DURANGO	2015-2021	3.6 lts	AP35898	PP79744		

MARCA	LÍNEA	AÑO	MOTOR	AIRE	ACEITE	COMBUSTIBLE	OTROS
DODGE	DURANGO	2015-2021	3.6 lts	AP35898			
DODGE	JOURNEY	2009-2019	2.4 LTS	AP35783	A160PLUS		AP31033
DODGE	JOURNEY	2009-2019	3.6 LTS	AP35932	PP79744		
DODGE	RAM 1000	2020-2022	1.8 LTS			PFG25121074	
DODGE	RAM 1500	2014-2019	3.6 LTS		PP79744		
DODGE	RAM 1500	2014-2019	5.7 LTS		A160PLUS		
DODGE	RAM 700/V700 RAPID	2019-2023	1.4 LTS		A1402	PFG25121074	
DODGE	RAM 2500 LARAMIE	2010-2018	5.7 LTS		A329		
DODGE	RAM 1500	2014-2019	4.7 LTS		A329		
DODGE	RAM 2500	1998-2010	6.4 LTS		A160PLUS		
DONG FENG	VANS CARGA	2014>	DONG FENG 1,0 Y 1,3	AP3588	A14476P		
FAW	BESTURN B50	2018-2021	1.6 LTS	AP3140	A178PLUS		
FAW	TAXI	2017>	1500 cc		A14476P		
FIAT	FIAT STRADA ADVENTURE	2009-2016	1.6 LTS	AP35840	PP13376	PFG25121074	
FIAT	FIAT 500 CULT, TOPOLINO 2013	2013	1.4 LTS	AP35247		PFG25121074	
FIAT	FIAT TIPO Y TEMPRA	2000	FIAT TIPO	AP3520			
FIAT	MOBI	2020-2022	1.0 LTS		A1402PLUS	PFG25121074	
FIAT	PULSE	2020-2022	1.0 LTS		A3603PLUS		
FIAT	PULSE	2020-2022	1.3 LTS		A3603PLUS	PFG1400	
FIAT	FIORINO	2003-2016	1.3 LTS	AP1275	A1402		
FIAT	NUEVO SIENA	2008-2014	1.4 LTS	AP1275	A1402	PFG25121074	
FIAT	PALIO	2002-2008	1.3 LTS	AP1275	A1402	PFG25121074	
FIAT	PALIO	2002-2008	1.6 LTS	AP1275	A1402	PFG25121074	
FIAT	PALIO	2000	4 CIL. INY		A4056		
FIAT	ARGO	2019- 2021	1.3 LTS		A4056	PFG25121074	
FIAT	CRONOS DRIVE	2019- 2021	1.3 LTS		A3603PLUS	PFG1400	
FIAT	CRONOS PRECISION	2018>	1.8 LTS				
FIAT	PALIO ELX	2010	1.4 y 1.8 LTS	AP1275	A4056	PFG1400	
FIAT	PALIO RACING	2005-2007	1.8 LTS	AP1275	A1402	PFG25121074	
FIAT	PALIO WEEKEND	2010	1.4 LTS	AP1275	A4056	PFG1400	
FIAT	SIENA	2002-2006	1.3 y 1.6 LTS	AP1275	A4056		
FIAT	SIENA ELX, FIRE	2010	1.4 LTS	AP1275	A4056		
FIAT	SIENA EX, ELX y LTS	2002-2006	1.3 - 1.4 LTS	AP1275	A4056		
FIAT	SIENA HLX	2010	1.4 y 1.8 LTS	AP1275	A4056		
FIAT	STRADA	2005-2006	1.3 LTS	AP1275	A1402	PFG25121074	
FIAT	STRADA 1.4 WORKING A.A	2012	1.4 LTS		A1402PLUS	PFG1400	
FIAT	STRADA PICK UP	2005	1.8 LTS	AP1275	A20		

MARCA	LÍNEA	AÑO	MOTOR	AIRE	ACEITE	COMBUSTIBLE	OTROS
FIAT	UNO	2011-2022	1.0,1.3 Y 1.4 LTS		A1402	PFG25121074	
FIAT	UNO CLUB, 70S	1994-1996	1.3 LTS		A4056		
FIAT	UNO CLUB, 70S	1994-1996	1.3 LTS		A4056		
FIAT	UNO FIRE	2005-2008	1.3 LTS	AP1275	A1402	PFG25121074	
FIAT	UNO FIRE SCR	2003-2008	1.6 LTS		A1402	PFG25121074	
FIAT	UNO VIVACE Y A.A	2012-2015	1.4 LTS		A20		
FORD	TRANSIT 250	2014-2020	2.5 LTS		A14302PLUS		
FORD	TRANSIT CONECC	2014-2022	2.5 LTS		A14302PLUS		
FORD	MOTORES 6 CILIN	1946-1957			PM18		
FORD	ECO SPORT	2006	2.0 LTS	AP35786	A329		AP31035
FORD	ECO SPORT	2006-2017	2.0 LTS	AP35815	A329		AP31035
FORD	ECO SPORT TITANIUM	2018-2021	1.0 LTS		A14302PLUS		
FORD	ECO SPORT TITANIUM	2018-2021	1.5 LTS / 2.0 LTS		A14302PLUS	PFG330	
FORD	ECO SPORT	2006	2.0 LTS	AP3536	A14302PLUS		AP31035
FORD	ECO SPORT 2.0 S 4X	2013-2017	2.0 LTS	AP35921	A14302PLUS		AP31035
FORD	ECO SPORT AUT	2009-2017	2.0 LTS	AP35782	A14302PLUS		AP31035
FORD	EDGE	2015-2017	3.5 LTS	AP31992	A160PLUS	PFG7802	
FORD	EDGE	2011-2015	3.5 LTS	AP35782	A160 / A160PLUS	PFG7802	
FORD	EDGE TITANIUM	2018>	2.0 LTS	AP31992	A14302PLUS	PFG7802	
FORD	ESCAPE	2006	3.0 Lt XLT AWD	AP3557	A329		
FORD	ESCAPE	2006	2.0 Lts INY	AP35893	A14302PLUS		
FORD	ESCAPE 2.3 LTS	2004-2009	2.3 LTS	AP3557	A14302PLUS		AP31015
FORD	EXPEDITION 5.4 L	2010-2015	5.4 LTS	AP3559	A329		
FORD	EXPLORER EDDIE BAUER	2006	4.6L 3V SOHC V8	AP35602	A329		
FORD	EXPLORER LIMITED	2013-2018	2300 cc	AP35782	A14302PLUS		
FORD	EXPLORER V6	2013-2017	3.5 V6	AP35782	A160 / A160PLUS		
FORD	EXPLORER ST	2021	3.0 LTS	AP35782			
FORD	EXPLORER AMERICANA	1995-1998	V6 4.0; V8 4.0		A1SP		
FORD	EXPLORER SPORT TRAC	2006-2010	4.0 Lt	AP35736	A329	PFG7802	
FORD	EXPLORER SPORT TRACK	2006-2012	4.6 LTS	AP35602	A329	PFG7802	AP31032
FORD	EXPLORER V6-245 4,0;AEROSTAR 3.0	1991-1994	V6-245 4.0; 3.0	AP3562	A1SP		
FORD	F150 RAPTOR	2013	V6. 3.5 Y 5.0		A329		
FORD	FIESTA	1997-2000	1,3 LTS 4 CILN INYECC	AP1330	A223	PFG1105	
FORD	FIESTA SUPERCHARGER	2004-2007	1.0 LTS	AP3531	A223PLUS		

MARCA	LÍNEA	AÑO	MOTOR	AIRE	ACEITE	COMBUSTIBLE	OTROS
FORD	FIESTA, HB, SEDAN AUT	2011-2019	1.6LTS	AP35844	A14302PLUS		
FORD	FIESTA, HB, SEDAN AUT	2011-2019	1.0LTS	AP35844	A14302PLUS		
FORD	FOCUS	2013-2017	2.0 LTS	AP35893	A14302PLUS	PFG7742	
FORD	FORD BRONCO , F 100	1996>	6 CIL V8	AP1305	A1SP		
FORD	FORD 250	1994>	5,4 LTS	AP1305	A73PLUS		
FORD	FORD ESCAPE 3.0 2009> SEL	2006-2013	3.0 LTS	AP23603	A160 / A160PLUS	PFG872	
FORD	FORD FESTIVA, MAZAD 121	1988-2000	KIA 13	AP146	A323PLUS		
FORD	F-150 LOBO	2004-2008	4.2 LTS	AP3515	A1SP	PFG872	
FORD	FUSION	2007-2012	3.0 LTS		A160 / A160PLUS		
FORD	FUSION	2007-2012	2.0 LTS	AP31992	A14302PLUS		
FORD	FUSION	2007-2012	2.0 LTS	AP35893	A14302PLUS		
FORD	FX 150 TRITON	2008-201	5.4 LTS	AP35755	A329		
FORD	LASER	1997-2007	L4 1.6 LTS	AP31521	A323PLUS		
FORD	ESCAPE	2017-2020	2.5 LTS		A14302PLUS		
FORD	ESCAPE	2017-2020	2.0 LTS				
FORD	BRONCO	2021-2023	2.0 LTS				
FORD	NEW ESCAPE	2013-2020	2.0 LTS	AP35893	A14302PLUS		
FORD	NEW EXPLORER XLT 4X2	2016	VARIOS	AP3559	A329		AP31032
FORD	RANGER 4X2	2000-2007	2.2 LTS	AP1365	A14302PLUS		
FORD	PROBE	1989-1992	6 CIL INYECCION		A243		
FORD	RANGER 4X2	2000-2007	6 CIL INYECCION		A243		
FORD	TAURUS	1986-1995	6 CIL INYECCION		A243		
FORD	RANGER D.C 4X2	2008-2009	2.2 LTS	AP603A	A1SP		
FORD	RANGER D.C 4X2 , 4x4	1999-2007	3.0 V6 182	AP1365	A178PLUS		
FORD	SERIE F PICK-UP	2009-2011	V8 INY 4.6 y 5.4Lt		A329		
FORD	TAURUS LX	2002-2005	1.6 LTS	AP1330	A372		
FOTON	MINI VANS	2016-2021	1,2 LTS	AP3514	A58PLUS	PFG25121074	
FOTON	MINI TRUCK	2020-2022	1,5 LTS				
FOTON	MINI TRUCK	2020-2022	1,2 LTS	AP3514	A58PLUS	PFG25121074	
GEELY	AUTOS GEELY. N/P 1	2011	LC 1,3	AP310005	A14476		
GEELY	C3 AUTOS	2012-2020	1.6 Lts	AP31550	A14476PLUS		
GEELY	CK AUTOS	2010-2014	1.5 Lts	AP31550	A14476PLUS		
GEELY	GEELY MK TAXI	2015>	1.5 Lts	AP310005	A14478PLUS	PFG330	
GEELY	GEELY MK	2011-2018	1.5 Lts		A14476PLUS	PFG330	
GEELY	LC AUTOS	2011-2018	1.3 Lts	AP31550	A14476PLUS		

MARCA	LÍNEA	AÑO	MOTOR	AIRE	ACEITE	COMBUSTIBLE	OTROS
GMC	SIERRA 1500	2007-2013	4.8 LTS		A160PLUS		
GMC	SIERRA 1500	2007-2013	5.3 LTS		A160PLUS		
GMC	SIERRA 1500	2007-2013	6.0 LTS		A160PLUS		
GMC	SIERRA 1500	2007-2013	6.2 LTS		A160PLUS		
GMC	SIERRA 2500 HD	2007-2019	6.2 LTS		A160PLUS		
GMC	SIERRA 3500 HD	2007-2019	6.2 LTS		A160PLUS		
GMC	MOTORES 2-53	1972			PM18		
GMC	YUKON	2000-2020	5.3 LTS		A52041SP		
GMC	YUKON	2000-2020	6.2 LTS		A52041SP		
GMC	YUKON	2000-2020	6.0 LTS		A160PLUS		
GMC	ACADIA	2020-2021	2.0 LTS				
GMC	ACADIA	2020-2021	2.5 LTS		A160PLUS		
GMC	ACADIA	2020-2021	3.6 LTS		A52041SP		
GMC	TERRAIN	2018-2020	2.0 LTS	AP99727	A160PLUS		
GMC	TERRAIN	2018-2020	1.5 LTS	AP99727	A160PLUS		
GREAT WALL	FLORID /CROSS	2012	1,5 LTS	AP31653	A14476	PFG330	
GREAT WALL	HAVAL H9	2020-2022	2.0 LTS		A15403		
GREAT WALL	VOLEEX C10 -C20 C30	2013>	1,5 LTS	AP31653	A1402	PFG330	
GREAT WALL	HAVAL M4	2015	1,5 LTS	AP31653	A58PLUS	PFG330	
GREAT WALL	HAVAL ALL NEW H6	2018-2022	1,6 LTS				
GREAT WALL	WINGLE 5	2012	2.4 LTS	AP31711	A52	PFG330	
GREAT WALL	HOVER	2008	2.0 LTS		A53PLUS	PFG330	
GREAT WALL	HAVAL 3	2011- 2013	2.0 LTS	AP311002	A53PLUS	PFG330	
GREAT WALL	HAVAL 5	2011	2.4 LTS	AP31923	A1402PLUS	PFG330	
HAFEI	HAFEI ,RUIYI,MINYI	2007	1.1 LTS	AP31701	A14476PLUS		
HAFEI	HAFEI ZHONGYI	2005-2011	1,0 LTS	AP31910	A14476PLUS		
HAFEI	HAFEI LOBO TAXI	2015>	1.0 LTS	AP31701	A14476PLUS		
HAFEI	MINI VAN ZHONGYI	2005-2010	1.0 Lt	AP31701	A14476PLUS	PFG330	
HAFEI	MINYI MPV	2005-2006	VARIOS	AP3193	A14476PLUS		
HONDA	ACCORD EXI, EXR AUT MFI	1998-2009	2.2. 2.4 Lt		A1402PLUS		
HONDA	ACCORD VII Y ACCORD VIII	2008-2012	2.4	AP3139	A1402PLUS		
HONDA	CR-V EX MEC y AUT	2007-2009	2.4 Lt	AP31773	A1402PLUS		
HONDA	CRV 2.0 16V	2002-2007	2.0 16V	AP1292	A1402PLUS		
HONDA	CRV	2017-2022	1.5 LTS		A1402PLUS		
HONDA	HRV	2016-2022	1.8 LTS		A1402PLUS		
HONDA	CRV 2.4 LTS IV	2017-2022	2.4 16V		A1402PLUS		
HONDA	ODYSSEY	2018-2022	3.5 LTS 16V		A1402PLUS		
HONDA	CITY	2022	1.5 LTS 16V		A1402PLUS		
HONDA	FIT	2015-2017	1.5		A1402PLUS		
HONDA	FIT	2015-2017	8V 1.4		A1402PLUS		

MARCA	LÍNEA	AÑO	MOTOR	AIRE	ACEITE	COMBUSTIBLE	OTROS
HONDA	FIT	2015-2017	1.5 LTS		A1402PLUS		
HONDA	FIT	2015-2017	1.5 LTS		A1402PLUS		
HONDA	HONDA CIVIC	1989>	1,6 LTS INY	AP3137	A323 / A52		
HONDA	HONDA CIVIC	1989>	1,5 LTS INY				
HONDA	HONDA CIVIC	1989>	1,8 LTS INY		A1402PLUS		
HONDA	HONDA CIVIC	1989>	2.0 LTS INY		A1402PLUS		
HONDA	HONDA CIVIC	1989>	1,5 LTS INY		A1402PLUS		
HONDA	HONDA CIVIC	1989>	1,5 LTS INY		A1402PLUS		
HONDA	HONDA CR-V MOTOR 4 CIL 2.0, DO	1994>	L4 1,7	AP1292	A323		
HONDA	LEGEND EX AWD	2008-2009	3.2 LTS		A329		
HONDA	NEW FIT LX, LXT	2007-2009	1.4 LTS	AP31700	A1402PLUS		
HONDA	PASSPORT	1994-2002	4 CIL INY 2.6		A1402		
HONDA	PILOT	2009-20015	V6-3500		A1402PLUS		
HONDA	PILOT	2009-20015	V6-3500		A1402PLUS		
HONDA	CRV CAMPERO	2005-2006	2.4 16V	AP63680	A1402PLUS		
HONDA	HONDA WR-V	2018-2022	WR-V 1.5		A1402PLUS	PFG25121074	
HYUNDAI	HYUNDAI SONATA	2005-2007	4 CIL. INY	AP31678	A52	PFG423	
HYUNDAI	ACCENT	2018-2021	1.6 LTS	AP35645	A53PLUS		AP31043
HYUNDAI	GETZ HB20	2021-2023	1.6 LTS		A58PLUS	PFG330	AP31739
HYUNDAI	ACCENT HB20S	2021-2023	1.6 LTS		A58PLUS	PFG330	AP31739
HYUNDAI	HB20X GRAVITI	2021-2023	1.6 LTS		A58PLUS	PFG330	AP31739
HYUNDAI	ACCENT GYRO GL	2003-2007	L4 1.3 y 1.5Lt	AP1375 / AP2600	A52	PFG319112500	
HYUNDAI	ACCENT GYRO HASTA 2002	2002	L4 1.5Lt	AP1375	A52	PFG319112500	
HYUNDAI	ACCENT VISION GLS 16V	2005-2009	L4 1.4y1.6Lt	AP29400	A1402PLUS		AP31042
HYUNDAI	ACCENT VISION GLS 4P 1.4 16V Y AUT, LS WEB II	2010-2013	1.4 16V	AP29400	A52		AP31043
HYUNDAI	ACCENT VISION GLS 4P 1.6 16V Y AUT,	2010-2013	1.6 16V	AP29400	A52		AP31043
HYUNDAI	ATOS	1999-2002	1.0lt	AP2510	A1402	PFG319110210	
HYUNDAI	ATOS PRIME, CITY TAXI	2004-2010	3CIL 1.0lt	AP3550	A1402PLUS	PFG319110500	
HYUNDAI	CRETA	2016-2022	1.6 lts	AP311028	A53PLUS		AP43100
HYUNDAI	ELANTRA NB	2017-2020	1,6 LTS / 2.0 LTS INY	AP311033	A53PLUS		AP31043
HYUNDAI	ELANTRA 1.6XD, 1.8, 2.0XD CRDI	2001-2004	1.6 LTS G4ED-G	AP3565	A52		AP31043
HYUNDAI	ELANTRA NEW	2000-2006	2.0 LTS	AP3108	A52		
HYUNDAI	EON	2014>	0.8 Lt		A1402		

MARCA	LÍNEA	AÑO	MOTOR	AIRE	ACEITE	COMBUSTIBLE	OTROS
HYUNDAI	EON	2015-2017	0,8 LTS		A1402		AP31055 / AP31743
HYUNDAI	GETZ	2003-2013	1.6 Lt	AP1000	A1402PLUS		
HYUNDAI	GETZ GL, GLS	2004	L4 1350cc	AP1000	A1402PLUS		
HYUNDAI	GETZ GL, GLS 16V	2006	L4 1.4Lt	AP1000	A1402PLUS		
HYUNDAI	GRAND CITY YAXI	2014	1.2	AP31936	A1402PLUS		AP31055 / AP31743
HYUNDAI	GRAND i10	2014	1.2 LTS	AP31936	A1402PLUS		AP31055 / AP31743
HYUNDAI	GRAND i10	2014	1.2 LTS	AP3120	A1402PLUS		
HYUNDAI	HI STAREX	1997-2008	2.4 lts	AP3932	A52		AP31006
HYUNDAI	HYUNDAI ACCENT 1,3 Y 1,5 HYUND	1994-1998	1,5 : 1,6 4 CIL. INY	AP1375	A52		
HYUNDAI	KONA	2018-2022	1.6 LTS	AP311020	A53PLUS		AP43100
HYUNDAI	HYUNDAI ATOS	1999-2004	3 CIL. INY	AP2510	A58	PGF3191102100	
HYUNDAI	i0 AUTO 1,0	2008-2017	1.2 LTS	AP31747	A1402PLUS		AP31055 / AP31743
HYUNDAI	i10 1.1 GL Y F.E.	2010-2014	1.1 LTS	AP3120	A1402PLUS		AP31055 / AP31743
HYUNDAI	i10 AUTO 1,0	2008-2010	1.0lt	AP3120	A58PLUS		
HYUNDAI	i20	2017>	1.4 LTS	AP311005	A1402PLUS		AP31043
HYUNDAI	i25 ACCENT	2012	1.4 Y 1.6	AP31100	A53PLUS		AP31739
HYUNDAI	i25 AUTO	2012	1.6 y1.4	AP31100	A1402PLUS		AP31739
HYUNDAI	i30	2008-2001	2.0 LTS	AP3144	A52		
HYUNDAI	i30	2008-2001	1.6 LTS	AP3144	A52		
HYUNDAI	i30 AUTO 2,0	2008-2010	2.0lt	AP3144	A1402PLUS		
HYUNDAI	i35	2010-2016	1.6 Y 1.8	AP31832	A52		AP31043
HYUNDAI	i45	2012-2015	2.4 LTS		A53PLUS		
HYUNDAI	IONIQ HIBRIDO	2017 -2021	1.6 LTS	AP311020	A53PLUS		
HYUNDAI	EXCEL	1998	1,3 LTS / 1,5 LTS	AP1372	A52		
HYUNDAI	NEW ELANTRA	2005	2.0 LTS	AP3144	A52		
HYUNDAI	NEW SANTA FE	2006	2.7 LTS	AP31588	A52		
HYUNDAI	NEW SANTA FE	2006	2.7 LTS	AP31697	A52		
HYUNDAI	PONY 1,3	2000	1.3 12V	AP3578	A52		
HYUNDAI	SANTA FE	2011-2014	3.3 LTS	AP31900			AP31029
HYUNDAI	SANTA FE	2011-2014	2.7 LTS	AP31588	A53PLUS		
HYUNDAI	SANTA FE	2011-2013	LA 2.4/ 2.7 LTS	AP31588	A52		
HYUNDAI	SANTA FE ADVANCE	2013-2017	2.4 LTS	AP31900	A53PLUS		AP31029
HYUNDAI	SANTRO	2005-2010	L4 1.0 y 1.1Lt	AP3550	A1402PLUS		
HYUNDAI	SONATA	2005-2009	2.4	AP35790	A53PLUS	PGF423	
HYUNDAI	STAREX H1	2005-2008	2.6 LTS	AP3932	A73PLUS		
HYUNDAI	TERRACAN	2006	L4 3500	AP1347	A58PLUS		
HYUNDAI	TERRACAN	2006	3.5. LTS	AP31652	A323PLUS		

MARCA	LÍNEA	AÑO	MOTOR	AIRE	ACEITE	COMBUSTIBLE	OTROS
HYUNDAI	TIBURON COUPE	2004-2006	2.0 Lt	AP3565	A52		
HYUNDAI	HYUNDAI ELANTRA, HIGHWAY, SANTA FÉ I, TRAJET, TUCSON; JEEP CHEROKEE; KIA CARENS II, CERATO, SPORTAGE 2.0D/2.5D	2001	2,0 LTS		PP27000		
HYUNDAI	TUCSON	2004-2010	2.7 LTS	AP3108	A178PLUS	PFG1001	AP31012
HYUNDAI	TUCSON	2004-2010	1.6 LTS	AP31980	A53PLUS		
HYUNDAI	TUCSON	2004-2010	2.4 LTS	AP31980	A53PLUS		AP43100
HYUNDAI	TUCSON 2.0 GASOLINA	2017-2022	2.0 LTS	AP31980	A53PLUS		
HYUNDAI	TUCSON IX35 2.0 GASOLINA	2011-2015	2.0 LTS	AP3145	A53PLUS		AP31739
HYUNDAI	TUCSON IX35 2.4 GASOLINA	2010-2015	2.4 LTS	AP3145	A53PLUS		AP31739
HYUNDAI	VELOSTER 1.6 F.E Y AUT	2010-2015	1.6 lts	AP31100	A73PLUS		AP31739
HYUNDAI	VERACRUZ	2007-2013	V8 3.8 Lt	AP31797	PP57061		
HYUNDAI	Hyundai Elantra 1.5, Excel gs, Excel 1.5 gsi	2000-2006	1.5 LTS	AP1360			
HYUNDAI	VELOSTER	2019-2021	1.6 lts	AP311033	A53PLUS		AP43100
HYUNDAI	VELOSTER	2019-2021	2.0 LTS	AP311033	A53PLUS		AP43100
HYUNDAI	PALISADE	2020-2022	3.8 LTS				
HYUNDAI	SANTA FE	2011-2014	2.0 LTS		A53PLUS		
IVECO	DAILY 65C14 GNV Pasajeros (gas)	2018	FPT F1CE044 2.998 cc				
JAC	B-CLASS	2014	2.0 LTS		A2863SP		
JAC	JAC TAXI SMILE	2013	1,0 LTS	AP319020	A1402		
JAC	JAC TAXI STAR	2015	1.6	AP3142	A1402	PFG319112500	
JAC	JAC J2	2011	1400 cc	AP319020	A1402		
JAC	JAC S2	2017-2022	1500 cc		A58PLUS		
JAC	JAC S3	2017-2022	1600 cc		A53PLUS		
JAC	JAC SMILE 1.3,	2012-2015	1,3 LTS	AP31904	A1402		
JAC	JAC VELOCE	2011	1,3 DOHC	AP3142	A1402	PFG319112500	
JEEP	CHEROKEE LIMITED	2014-2018	3,2 lts				
JEEP	CHEROKEE LIMITED AUT	2006-2007	3.7 Lts		A223PLUS		
JEEP	CHEROKEE RENEGADE, SPORT	2006-2007	VARIOS		A20		
JEEP	CHEROKEE SFI	1987-2001	L6 242 4.0 LTS	AP1323	A20		
JEEP	COMPASS PATRIOT	2007-2010	2.4 LTS	AP35741	A160 / A160PLUS		AP31033

MARCA	LÍNEA	AÑO	MOTOR	AIRE	ACEITE	COMBUSTIBLE	OTROS
JEEP	GRAN CHEROKEE LAREDO	2006-2007	VARIOS	AP3574	A20		
JEEP	GRAN CHEROKEE LIMITED	2006-2007	VARIOS		A20		
JEEP	GRAND CHEROKEE	2011	5.7	AP35898	A329		
JEEP	GRAND CHEROKEE LIMITED	2011-2015	3.0 lts	AP35898	PP79744		
JEEP	JEEP CADILAC, OLDMOBIL	1970-1979	JEEP		A26SP		
JEEP	JEEP GRAN CHEROKEE-WRANGLER	2007-2010	V6- 231	AP31795	A223		
JEEP	RENEGADE	2018-2022	1,8 LTS INY			PFG25121074	
JEEP	WRANGLER SPORT	2007-2011	3.8 Lts GASOLINA		A223PLUS		
JEEP	JEEP COMPASS	2018-2022	1,4 LTS				
JEEP	JEEP COMPASS	2018-2022	2,4 LTS		A160PLUS		
KIA	SOUL	2009-2014	1.6 lts	AP311033	A53PLUS		AP43100
KIA	CERATO VIVRO	2020-2022	2.0 LTS	AP311033	A53PLUS		AP31043
KIA	CERATO VIVRO	2020-2022	1.6 lts	AP311033	A53PLUS		AP31043
KIA	KIA CLARUS	1996-1998	1.8 LTS	AP31622	A58		
KIA	KIA SEPHIA FI 1,0	1994-1997	2.0 LTS	AP3582	A58		
KIA	SELTOS	2022	1.6 LTS / 2.0 LTS	AP311005	A53PLUS		AP43100
KIA	AMANTI V6 INYECC	2004	3.500 cc	AP3524	A52		
KIA	CARENS 1,8 GLS MEC	2004	L4 1.8 y 2.0lt		A1402PLUS		
KIA	CARENS II RONDO	2014-2019	2.0 LTS	AP3532	A52		AP31043
KIA	TELLURIDE	2020-2022	3.8 LTS				
KIA	CARNIVAL	2006-2010	VARIOS	AP3122	A092SP		
KIA	CARNIVAL 2,4 GASOLINA 24VAL	2001	2.4 Lt	AP3524	A1402PLUS		
KIA	CERATO 1.6 , 2.0	2004>	G4GC	AP3565	A323PLUS		
KIA	CERATO CICLON	2008>	VARIOS	AP31734	A52		
KIA	CERATO FORTE	2009-2014	1.2 Y 1.6 LTS	AP3144	A52		AP31739
KIA	SONET	2022-2023	1.5 LTS	AP311005			AP43100
KIA	CERATO KOUP	2009-2014	1.6 Y 2.0 LTS	AP31832	A52		AP31739
KIA	GRAN SEDONA	2016-2018	3.3 LTS				AP31029
KIA	KIA SEPHIA INYECCIÓN 2.0 LTS	1998-2001	2.0 LTS	AP3581	A58		
KIA	KIA SPORTAGE GASOLINA PANAL RI	1994-2005	2.0 Lt	AP3121	A1402PLUS		
KIA	STONIC	2021>	1.0 LTS	AP35645	A53PLUS		AP43100
KIA	TONIC	2021>	1.6 LTS	AP35645	A53PLUS		AP43100
KIA	SOLUTO	2020-2022	1.4 LTS	AP31744	A53PLUS		AP31739
KIA	MAGENTIS	2005-2009	2.0 LTS	AP31588	A52		

MARCA	LÍNEA	AÑO	MOTOR	AIRE	ACEITE	COMBUSTIBLE	OTROS
KIA	MAGENTIS	2010	VARIOS	AP35790			
KIA	MAGENTIS 4CIL INYECC	2002	4CIL Inyecc		A323PLUS		
KIA	MOHAVE	2009-2014	3.8 LTS		PP3C30A		
KIA	MOHAVE	2009-2014	3.0 LTS		A52		
KIA	NEW PICANTO ION	2018>	1.0 y 1,2 LTS	APG6000	A1402PLUS		
KIA	NIRO HIBRIDO	2017 -2021	1.6 LTS	AP311020	A53PLUS		
KIA	OPIRIUS V6	2006	3.5LT		A58PLUS / A1402PLUS		
KIA	OPIRUS	2005-2009	3.8 LTS		PP57061		
KIA	OPTIMA	2010-2016	2.0 Lts		A323PLUS		AP31029
KIA	PICANTO ION	2012-2017	1.2 LTS	AP31820	A1402PLUS	PFG1058	AP31055 / AP31743
KIA	PICANTO ION	2012-2017	1.1 LTS	AP31820	A1402PLUS	PFG1058	AP31055 / AP31743
KIA	PICANTO ION ECO TAXI	2012-2017	1.1 Y 1.2 LTS	AP31820	A1402PLUS	PFG1058	AP31055 / AP31743
KIA	PICANTO, ECO TAXI	2011-2014	L4 1.1Lt	AP3102	A58PLUS / A1402PLUS		
KIA	PRIDE POP	2000-201	VARIOS		A1402PLUS		
KIA	NEW RIO	2018-2023	1,6 LTS	AP35645	A58PLUS / A1402PLUS		AP43100
KIA	RIO	2018-2023	1,4 LTS	AP35645	A58PLUS / A1402PLUS		AP43100
KIA	RIO NB, HB	2001-2007	L4 1.5lt	APSL40A	A1402PLUS	PFG367	
KIA	RIO NEW XCITE	2006-2011	1.4 Y 1.6	AP29400	A52	PFG1C000	AP31739
KIA	RIO SPICE	2012-2017	1.2 Y 1.4	AP31100	A52		AP31739
KIA	RIO SPICE / EX-UB	2011-2017	1.2 Y 1.4	AP31100	A52		AP31739
KIA	RIO STYLUS	2008-2015	1.5 LTS	APSL40A	A52	PFG367	AP31739
KIA	RIO TAXI 1,5 y 1,6	2008	1.5 y 1.6 Lt	APSL40A	A58PLUS / A1402PLUS		
KIA	RIO XCITE	2007	L4 1.4lt	AP29400	A58PLUS / A1402PLUS		
KIA	SEDONA	2006-2007	V6 3.8 Lt	AP3524	PP57061		
KIA	SEDONA	2010>	V6 3.8 Lt	AP3524	A323PLUS / A1402PLUS		
KIA	SHEPIA III	1998-2003	1.8 LTS	AP3582	A1402PLUS		
KIA	SORENTO	2002-2009	2.4 LTS	AP31797	A53PLUS		
KIA	SORENTO	2002-2009	3.5 LTS	AP31797			
KIA	SORENTO	2004	2.5 LTS	AP3112	A323PLUS / A1402PLUS		
KIA	SORENTO	2004	V6 3500	AP3112	A73PLUS		
KIA	SORENTO RADICAL	2008-2014	2.4 LTS	AP31900	A53PLUS		
KIA	SORENTO TRUST	2014-2015	2.4 LTS				
KIA	SORENTO TRUST	2014-2015	2.4 LTS	AP31900	A53PLUS		
KIA	SOUL	2009-2014	1.6 lts	AP31744	A52		
KIA	SUPER VIP	2020-2021	1.6 lts	AP311033	A53PLUS		AP43100

MARCA	LÍNEA	AÑO	MOTOR	AIRE	ACEITE	COMBUSTIBLE	OTROS
KIA	SUPER EKO	2017-2019	1.6 lts	AP31744	A53PLUS		
KIA	SOUL	2010-2019	2.0 lts	AP31100	A52		
KIA	SOUL SIX PACK / NEW SOUL	2010-2014	1.6 lts	AP31100	A52		
KIA	SPECTRA NB, LS	2002-2003	1.5 y 1.6 Lt	AP3581	A58PLUS		
KIA	SPORTAGE	2017-2021	2.4 LTS	AP31985	A53PLUS		AP31739
KIA	SPORTAGE	2017-2021	2.0 LTS	AP31980	A53PLUS		AP43100
KIA	SPORTAGE	2017-2021	2.4 LTS	AP31980	A53PLUS		
KIA	SPORTAGE	2011-2014	2.0 LTS	AP3108	A53PLUS		AP31739
KIA	SPORTAGE INYECCION	2011-2014	2.0 Lt	AP3145	A53PLUS		AP31739
KIA	SPORTAGE REVOLUTION	2010-2012	2.0 Y 2.4 LT	AP3145	A53PLUS		AP31054
KIA	SPORTAGE REVOLUTION	2010-2012	2.0 Y 2.4 LT	AP3145	A53PLUS		AP31054
KIA	TAXI 5,5	2013-2015	1.5	AP3144	A52		AP31054
LAND ROVER	CAMPEROS LAND ROVER SANTA ANA	1963-1975	2250 CC		PM313	PFG516K	
LAND ROVER	FREELANDER TL2 V6 INYECC	2002	2.5Lt	AP3136			
LEXUS	NX300	2018-2021	2.0 LTS	AP35898			AP31071
LEXUS	GX460	2010-2022	4.6 LTS		PP31060		AP31071
LEXUS	ES350	2007-2021	3.5 LTS				AP31071
LEXUS	RX350	2016-2021	3.5 LTS	AP35898			AP31071
LEXUS	ES 300	1992 -2001	3.0 Lts	AP3135	A14302PLUS		
LEXUS	RX 300	1999 - 2003	3.0 Lts	AP3135	A14302PLUS		
LINCOLN	CONTINENTAL	1988-1994	6 CIL INYECCION		A243		
LINCOLN	CONTINENTAL	1988-1994	2.7 LTS	AP31992			
LINCOLN	CONTINENTAL	1988-1994	3.0 LTS	AP31992			
LINCOLN	CONTINENTAL	1988-1994	3.7 LTS	AP31992			
LINCOLN	MKX	2016-2018	2.7 LTS	AP31992			
LINCOLN	MKX	2016-2018	3.7 LTS	AP31992			
LINCOLN	MKZ	2017-2018	2.0 LTS	AP31992			
LINCOLN	MKZ	2017-2018	2.0 LTS	AP31992			
MAZDA	MAZDA ASTINA, 323 IMPO	1990-1987	1.5 LTS	AP31585	A323		
MAZDA	MAZDA MATSURI 626	1993-1997	4 CIL. INY	AP3509	A73PLUS	PFG0120490B	
MAZDA	MAZDA MX6	1998-2004	4 CIL. INY	AP35606	A1402	PFG335	
MAZDA	2 SKYACTIVE	2016-2022	1.5 LTS	AP31962	A58PLUS		
MAZDA	3 SKYACTIVE	2015-2023	1.5	AP31962	A58PLUS		AP31096
MAZDA	3 SKYACTIVE	2015-2023	2.0 lts	AP31899	A58PLUS		AP31096
MAZDA	3 SKYACTIVE	2015-2023	2.5 lts	AP31899	A58PLUS		AP31096
MAZDA	5 Y AUT	2007-2010	2.3 Lt	AP3109	PP6		
MAZDA	6 SKY ACTIVE	2013-2016	2.5 Lts	AP31899	A58PLUS		AP31096

MARCA	LÍNEA	AÑO	MOTOR	AIRE	ACEITE	COMBUSTIBLE	OTROS
MAZDA	6 SKY ACTIVE T	2019-2021	2.5 Lts		A58PLUS		AP31096
MAZDA	6 Chasis 195596	2004-2010	2.0 Lt	AP3140	PP6		
MAZDA	626 LX	2000	2.0 L4 12V	AP35606	A1402	PFG0120490B	
MAZDA	ALL NEW MAZDA 3 1.6 SPORTR	2011-2014	1.6 LTS	AP3111	A58PLUS	PFG25121074	
MAZDA	B2200	1997-2003	2.2 LTS	AP3101	A73PLUS	PFG335	
MAZDA	B2600	1998-2001	2.6 LTS	AP3101	A73PLUS	PFG335	
MAZDA	BT 50	2008-2013	2.2 / 2.6 LTS	AP3101	A73PLUS	PFG335 /PFG357	
MAZDA	CX3	2016>	2.0 LTS	AP311019	A58PLUS		
MAZDA	CX5	2007-2009	2.5 Lts	AP3109	PP6		
MAZDA	CX5 SKYACTIVE	2012-2021	2.5 Lts	AP31899	A58PLUS		AP31096
MAZDA	CX5 SKYACTIVE	2012-2021	2.0 LTS	AP31899	A58PLUS		AP31096
MAZDA	CX7	2009-2014	2.3 LTS	AP3140	PP6		
MAZDA	CX7	2009-2014	2.3 ; 2.5	AP31834	A223PLUS		
MAZDA	CX9	2009-2014	3.5 LTS	AP31782	A178PLUS		
MAZDA	CX5 T	2020-2023	2.5 LTS		A58PLUS		AP31096
MAZDA	CX9 T	2017-2023	2.5 LTS		A58PLUS		AP31096
MAZDA	CX9	2009-2014	3.7 LTS	AP31782	A178PLUS		
MAZDA	CX9	2009-2014	3.7 LTS	AP3140	PP6		
MAZDA	DEMIO	2005-2008	1.3 LTS		A52		
MAZDA	DEMIO	2005-2008	4 CIL. INY 1.4 Lt	AP3540	A1402		
MAZDA	MATSURI MILENIUM CCA	1990-2006	2.2 LTS	AP3509	A73PLUS	PFG0120490B	
MAZDA	MAZDA 2	2008-2014	1.5 Lt	AP3111	A58PLUS		
MAZDA	MAZDA 3	2006-2017	L4 2.0Lt	AP3109	A223PLUS		
MAZDA	MAZDA 3	2005-2014	L4 1.6 Lt	AP3111	A58PLUS		
MAZDA	MAZDA 323HE, 323HS, 323NS, 323	1986-1997	4 CIL. CAR	AP323 / AP323A	A323	PFG516K	
MAZDA	MAZDA 6	2004-2010	2.3 Lts	AP3140	A58PLUS		
MAZDA	MAZDA 6	2004-2010	2.5 Lts	AP31899	A58PLUS		
MAZDA	MAZDA 6	2004-2010	2.0 Lt	AP3140	PP6		
MAZDA	MAZDA 626 , MAZDA B-2000	1989-2000	4 CIL. CAR	AP626	A73PLUS		
MAZDA	MAZDA ALEGRO 1.300	1995-2000	1.3	AP3511	A73PLUS		
MAZDA	MAZDA CX7 2.3 2.5 2007-20	2007-2012	2,3 I TURBO	AP31834	PP6		
MAZDA	MAZDA MATSURI 626 PANAL R	1993-1997	4 CIL. INY	AP31559	A73PLUS	PFG0120490B	
MAZDA	MILENIA	2001-2004	6 CIL INY	AP35606	A1402PLUS		
MAZDA	NEW 5	2011-2012	2.0 Lt	AP3109	A223PLUS		
MAZDA	B 2000 Pick Ups B 2200 B 2600 Pick Ups	1986-2000	L4 2,0	AP6261	A73	PFG516K	
MAZDA	Mazda B 2.000 Ch. / Pl.	1986-2000	L4 2,0	AP6261	A73	PFG516K	

MARCA	LÍNEA	AÑO	MOTOR	AIRE	ACEITE	COMBUSTIBLE	OTROS
MAZDA	CX30	2021>	2.5 LTS		A58PLUS		
MAZDA	CX30	2021>	2.0 LTS		A58PLUS		
MAZDA	CX3	2016>	2.0 LTS	AP311019	A58PLUS		
MERCEDES BENZ	SPRINTER 1500	2020-2021	2.0 LTS	AP35756			
MERCEDES BENZ	SPRINTER 2500	2020-2021	2.0 LTS	AP35756			
MERCEDES BENZ	C180	1993-2008	1.8		PP40425		
MERCEDES BENZ	C200	1992-2000	2		PP40425		
MERCEDES BENZ	MERCEDEZ C-30 Y 330	1999	6 CIL INY.	AP3546			
MERCEDES BENZ	ML 320	2007	V6-3498cc		PP7181		
MINI COOPER	MINI COOPER III	2014-2023	1.5 LTS				
MINI COOPER	MINI COOPER III	2014-2023	2.0 LTS				
MITSUBISHI	GRANDIS	2005-2009	2.4 LTS	AP31950	A52		AP31019
MITSUBISHI	MITSUBISHI GALANT F.I. PA	1994-2003	FY 2,4 INY	AP3138	A1402PLUS		
MITSUBISHI	ASX	2010-2013	2.0lt	AP31788	A1402PLUS		
MITSUBISHI	ASX	2010-2013	2.0lt	AP31950	A1402PLUS		
MITSUBISHI	CAMPERO V6 3400	2001>	V63400/3800	AP31624	A1402PLUS		
MITSUBISHI	ECLIPSE AUT	2007-2012	2.4 LTS		A52		
MITSUBISHI	ECLIPSE CROSS	2019-2021	2.0 LTS	AP31950	A1402PLUS		
MITSUBISHI	ECLIPSE AUT	2007-2012	3.8 LTS		A52		
MITSUBISHI	GALANT V6	2007	V6 2.5 Lts		A1402PLUS		
MITSUBISHI	L200 2,4	2020	2.4 LTS	AP3105 / AP3118	A1402		
MITSUBISHI	L300	1991-2007	4 CILIN INYEC	APL300	AR9	PGF1100	
MITSUBISHI	L-300 PANEL GASOLINA	2006	2.0 LTS	APL300	A1402PLUS		
MITSUBISHI	RVR	2015-2019	2.4 LTS	AP31950	A1402PLUS		
MITSUBISHI	LANCER 2000 RALLIART	2006-2007	2.0 LTS	AP3128	A1402PLUS		
MITSUBISHI	LANCER AVANZADO	2008-2016	2.0 LTS	AP31950	A1402PLUS		
MITSUBISHI	LANCER AVANZADO TURBO	2010-2016	2.0 LTS	AP31950	A52		
MITSUBISHI	LANCER NEW 4CIL INY	2006-2007	1.3-1.6 / 2.0lt	AP3128	A1402PLUS		
MITSUBISHI	MITSUBISHI LANCER WEW	2002-2007	1,3 CC - 4 CIL. INY	AP31564	A1402PLUS		
MITSUBISHI	MITSUBISHI MIRAGE	2017-2021	1,2 LTS		A1402PLUS		
MITSUBISHI	MITSUBISHI MIRAGE	2017-2021	4 CIL. INY	AP31563	A1402PLUS		

MARCA	LÍNEA	AÑO	MOTOR	AIRE	ACEITE	COMBUSTIBLE	OTROS
MITSUBISHI	MITSUBISHI : MONTERO 3.8 WAGON Q	1989	3.8 CAR	AP33	A323		
MITSUBISHI	MONTERO V6	2009-2010	3.0 LTS	AP3105	A1402PLUS		
MITSUBISHI	MONTERO V6	2009-2010	V6 3.5 INYECC	AP31531	AR9	PGF44781	
MITSUBISHI	NATIVA	2010-2014	3.5 LTS	AP3115	A52		
MITSUBISHI	NATIVA ABC	1998-2006	V6 3.0 LTS	AP3118	A1402PLUS		
MITSUBISHI	NEW MONTERO	2006	3.8 LTS	AP31531	A1402PLUS	PGF44781	
MITSUBISHI	OUTLANDER	2010-2016	2.4 LTS	AP31788	A52		
MITSUBISHI	OUTLANDER	2010-2016	3.0 LTS	AP31788	A52		
MITSUBISHI	OUTLANDER KAITEKI	2016-2023	2.0 Y 2.4 LTS	AP31950	A1402PLUS		
MITSUBISHI	OUTLANDER AUT	2005-2009	2.4 LTS	AP3128	A1402PLUS		
MITSUBISHI	SANTAMO	2000	6 CIL INY		A1402		
MITSUBISHI	V6 3400	2001-2014	3.4	AP31624	A52		
MITSUBISHI	V6 3800	2001-2014	3.8	AP31624	A52		
NISSAN	NV1500	2012-2021	4.0 Lts	AP3574	A1402PLUS		AP43100
NISSAN	NV200	2013-2021	2.0 Lts	AP3132	A1402PLUS		
NISSAN	NV2500	2012-2021	4.0 Lts	AP3574	A1402PLUS		AP43100
NISSAN	NV2500	2012-2021	5.6 Lts	AP3574	A1402PLUS		AP31060
NISSAN	NV3500	2012-2017	5.6 Lts	AP3574	A1402PLUS		AP31060
NISSAN	NV3500	2012-2017	4.0 Lts	AP3574	A1402PLUS		AP43100
NISSAN	NISSAN PATROL	1992-2000	JAP- Y61 CAR	AP35553	A113		
NISSAN	ALMERA	2000-2006	1.6 LTS	AP3533	A1402PLUS	PGF1104	
NISSAN	ALMERA SG SEDAN	2005-2008	L4 1.6	AP1312	A1406PLUS		
NISSAN	ALMERA XG	2006-2007	L4 1.8Lt	AP1312	A1406PLUS		
NISSAN	ALTIMA	2006	2.5 Lt	AP1312	A1402PLUS		
NISSAN	ALTIMA	2006	2.0 Lt		A58PLUS		
NISSAN	ALTIMA S. E.	2006	3.5 Lt	AP1312	A1402PLUS		
NISSAN	CAMPEROS NISSAN, AUSTIN, HALEY	1969-1980	4 CIL. CAR		PM126	PGF516K	
NISSAN	D21	1994-2008	2.4 INJ	AP31544	A113	PGF4000	
NISSAN	FRONTIER	2004-2012	2.4 Lt	AP2825	A1402PLUS		AP31060
NISSAN	JUKE	2013-2016	1.6 LTS	AP3533	A58PLUS		
NISSAN	QUEST	2004-2017	3.5 LTS	AP1312	A1402		
NISSAN	XTERRA	2005-2015	4.0 LTS	AP3574	A1402		AP31060
NISSAN	KICKS	2017 -2023	1.6 LTS		A58PLUS		
NISSAN	MARCH	2012-2017	1.6 LTS	AP31461	A1402PLUS		
NISSAN	MICRA	2007-2010	1.4 LTS	AP35733	A1406PLUS		AP31090
NISSAN	MURANO Y AUT F.E	2013-2016	3.5 LTS	AP1312	A1402PLUS		
NISSAN	NEW SENTRA	2017-2019	1.6 LTS	AP3533	A58PLUS		
NISSAN	NISSAN ADWAGON	1995>	1.6 LTS	AP3130	A113		

MARCA	LÍNEA	AÑO	MOTOR	AIRE	ACEITE	COMBUSTIBLE	OTROS
NISSAN	NISSAN ALTIMA 2.5 LTS	2013-2018	2,5 LTS	AP31944	A58PLUS		
NISSAN	NISSAN I PATHFINDER	1999- 2001	3,5 LTS	AP1312	A1402PLUS		
NISSAN	NISSAN PATROL	1993 - 2010	ZD30	AP1312	A20		
NISSAN	NISSAN VANNETE MICROBUS.	1987>	4 CILINDROS INY	AP16546	A113		
NISSAN	NOTE	2014-2016	1.4 LTS / 1,6 LTS	AP3132	A58PLUS		AP31090
NISSAN	PATHFINDER 6CIL	2005>	6CIL INYECC	AP3574	A1402PLUS		
NISSAN	PATHFINDER 6CIL	2005>	6CIL INYEC	AP1312	A1402		
NISSAN	PATHFINDER 6CIL	2005>	6CIL INYEC	AP1312	A113	PFG1105	
NISSAN	PATHFINDER 6CIL	2005>	6CIL INYEC	AP1312	A1402		
NISSAN	PATHFINDER desde 9	1997-2004	3.3 LTS	AP1312	A58PLUS		
NISSAN	QASHQAI	2009-2014	1.6 LTS Y 2.0 LTS	AP35750	A58PLUS		AP31097
NISSAN	QASHQAI	2009-2014	1.3 LTS	AP3565			AP31097
NISSAN	QASHQAI	2009-2014	2.0 LTS		A58PLUS		
NISSAN	SENTRA	2012-2016	1.8 LTS INY	AP3132	A1402PLUS		
NISSAN	SENTRA B17	2014-2020	1.8 LTS INY	AP3533	A58PLUS		AP31088
NISSAN	SENTRA B18	2021>	2.0 LTS INY	AP3561	A58PLUS		
NISSAN	SENTRA B14	1997-2001	L4 2.0	AP3533	A1406PLUS		
NISSAN	SENTRA B14	1997-2001	1.6 LTS	AP3533	A113	PFG1163	
NISSAN	SENTRA 8 VA	1992-2006	L4 1.6 LTS	AP1312	A113	PFG1163	
NISSAN	ROGUE	2017-2021	2.0 LTS		A58PLUS		AP31097
NISSAN	TEANA MCVT	2009-2017	3.5 LTS	AP1312	A1402		
NISSAN	ROGUE	2017-2021	2.5 LTS				
NISSAN	SENTRA B13	1999-2007	A.6 INJ	AP3533	A1406PLUS	PFG1163	
NISSAN	SENTRA B15	2011-2006	1.8 LTS INY	AP1312	A1402PLUS	PFG1163	
NISSAN	TIIDA	2011-2016	1.6 LTS /1,8 LTS	AP3132	A1402PLUS	PFG1104	AP31088
NISSAN	TIIDA CONFORT, EMOTION, PREMIUN	2007-2010	1.8 LTS	AP3132	A58PLUS		
NISSAN	TITAN	2010-2014	5.6 LTS	AP3574	A1402PLUS		
NISSAN	VERSA II	2020-2023	1.6 LTS		A1402PLUS		AP31097
NISSAN	VERSA ADVANCE	2012-2018	1.6 LTS	AP31461	A1402PLUS		AP31088
NISSAN	X-TRAIL	2014-2016	2.5 LTS	AP3533	A58PLUS		AP31097
NISSAN	X-TRAIL X, X-LTD AUT - MEC	2007-2014	2.5 LTS	AP1312	A58PLUS / A1402PLUS		
NISSAN	X-TRAIL 6CIL	2003-2003	3.3 LTS	AP1312	A1402PLUS		
NISSAN	X-TRAIL ADVANCE	2015-2023	2.5 LTS		A58PLUS / A1402PLUS		AP31097
OPEL	AUTOMOVILES AGUILA	2004-2008	1.2 LTS		PP92425		

MARCA	LÍNEA	AÑO	MOTOR	AIRE	ACEITE	COMBUSTIBLE	OTROS
PEUGEOT	106	1996-2010	1.4 LTS		A1402PLUS		
PEUGEOT	207	2006-2014	1.6 LTS		PP358		
PEUGEOT	207	2006-2014	1.4 LTS	AP35933	PP358		
PEUGEOT	2008 Y 3008	2012-2016	1.6 LTS		PP358		
PEUGEOT	307 XR, XS 1,6 16V 5P	2001-2005	L4 1.6lt		PP4780	PFG1195	
PEUGEOT	PEUGEOT	2009-2013	1.6 LTS	AP35843	PP358		
PEUGEOT	PEUGEOT 206 1,4 Y 1,5	2005 >	1,4 ; 1,5 LTS	AP35672	PP4780	PFG330	
PEUGEOT	PEUGEOT 301	2014-2021	1.6 LTS	AP35941	PP358		
PEUGEOT	PEUGEOT 206 207 (R)	1998-2000		AP35672		PFG330	
RAM	RAM 3500	2014-2018	6.4 LTS		A160PLUS		
RAM	RAM 4500	2014-2020	6.4 LTS		A160PLUS		
RAM	PROMASTER CITY	2015-2021	2.4 LTS		A160PLUS		
RAM	RAM 5500	2014-2020	6.4 LTS		A160PLUS		
RANGE ROVER	EVOQUE	2018			A14302PLUS		
RENAULT	CAPTUR	2023	1.3 LTS			PFG1195	
RENAULT	CAPTUR	2023	2.0 LTS	AP35968	A3603PLUS	PFG1195	
RENAULT	CITIVS	2006-2010	1.4	AP3554	A3603PLUS	PFG1195	
RENAULT	CLIO	2001-2012	1.4	AP3554	A3603PLUS	PFG1195	AP31063
RENAULT	CLIO CAMPUS	2013-2017	2	AP4439	PP6705	PFG1195	AP31063
RENAULT	CLIO CAMPUS	2013-2017	1.2	AP4439	A58PLUS	PFG1195	AP31063
RENAULT	CLIO COOL	2007-2009	1.6	AP1087	A3603PLUS	PFG1195	AP31063
RENAULT	CLIO DYNAMIQUE	2003-2007	L4 1.6 Lt	AP3554	A3603PLUS	PFG1195	AP31063
RENAULT	CLIO EXPRESSION	2006-2007	L4 1.6 Lt	AP1087	A3603PLUS	PFG1195	AP31063
RENAULT	CLIO R	1996-2001	L4 1.4	AP1087	A3603PLUS	PFG1195	AP31063
RENAULT	CLIO STYLE	2015-2016	1.2	AP4439	A58PLUS		AP31063
RENAULT	DUSTER	2013-2015	1.6 LTS	AP3554	A3603PLUS		AP31068
RENAULT	DUSTER DINAMIQUE	2017>	2.0 LTS	AP35968	A3603PLUS	PFG1195	AP31090
RENAULT	DUSTER EXPRESSION	2013-2015	1.6 LTS	AP3554	A3603PLUS	PFG1195	AP31090
RENAULT	DUSTER	2013-2015	1.6 LTS	AP3554	A3603PLUS	PFG1195	AP31090
RENAULT	DUSTER	2013-2015	1.3 LTS				
RENAULT	DUSTER	2013-2015	1.6 LTS		A58PLUS		
RENAULT	DUSTER OROCH	2017-2022	2.0 LTS	AP35968	A3603PLUS	PFG1195	AP31090
RENAULT	FLUENCE CONFORT	2012-2014	1.6 LTS	AP35887	A3603PLUS	PFG1195	
RENAULT	FLUENCE PRIVILEGE	2014-2015	2.0 LTS		A3603PLUS	PFG1195	
RENAULT	GRAND SCENIC	2008-2010	2.0 LTS	AP3554	A3603PLUS	PFG1195	
RENAULT	KANGOO EXPRESS	2013-2014	1.6 LTS	AP3554	A3603PLUS	PFG1195	AP31063
RENAULT	KANGOO EXPRESS, METROPOLI	2003-2007	L4 1.6 LTS	AP0978	A3603PLUS	PFG1195	
RENAULT	KANGOO SPORTWAY	2008-2010	1.6 LTS	AP0978	A3603PLUS	PFG1195	

MARCA	LÍNEA	AÑO	MOTOR	AIRE	ACEITE	COMBUSTIBLE	OTROS
RENAULT	KOLEOS	2009-2014	2.5 LTS	AP3533	A58PLUS		AP31097
RENAULT	KOLEOS DYNAMIQUE	2009	2.5 LTS	AP0978	A3603PLUS		
RENAULT	KWID	2019>	1,0 LTS 12 VAL	AP3565	A58PLUS	PFG405 / PFG330 / PFG323	AP31064
RENAULT	LAGUNA II 2,0	1999-2005	L4 1.8 - 2.0 LTS	AP3554	A3603PLUS	PFG1195	
RENAULT	LOGAN	2012-2017	1.4 LTS	AP0978	A3603PLUS		AP31064
RENAULT	LOGAN	2012-2017	NISSAN 1.6 LTS	AP35968	A1402PLUS		
RENAULT	LOGAN	2012-2017	1.6 LTS	AP35886	A3603PLUS		AP31090
RENAULT	LOGAN	2012-2017	1.4 LTS	AP3554	A3603PLUS		AP31064
RENAULT	MASTER VAN	2010>	2.5 LTS	AP35800	PP72321		AP31102
RENAULT	MEGANE III	2013-2015	2.0 LTS	AP35846	A58PLUS	PFG405	
RENAULT	MEGANE I	2000-2009	1.4 Y 1.6 LTS	AP3554	A3603PLUS	PFG1195	AP31065
RENAULT	MEGANE II	2005-2011	L4 2.0 LTS	AP3561	A3603PLUS	PFG1195	AP31065
RENAULT	METROPOLI 01	2001-2003	L4 1.4 LTS	AP0978	A3603PLUS	PFG1195	
RENAULT	NUEVA KOLEOS	2017-2019	2.5 LTS		A58PLUS		AP31097
RENAULT	NUEVO SANDERO STEPWAY	2018>	1.6 LTS	AP35886	A3603PLUS		AP31090
RENAULT	RENAULT 12 TODOS; DACIA AUTOMÓ	1972-1980	4 CIL. CARB	APR12	AR1218	PFG516K	
RENAULT	RENAULT 18 TODOS MENOS R-18/2	1981-1987	4 CIL. CARB	APR18	AR1218	PFG516K	
RENAULT	RENAULT 4, RENAULT 6.	1972-1981	4 CIL. CARB	AP3	AR4M		
RENAULT	RENAULT 9 GTL, TSE, BRIO, GTX,	1984-1996	RENAULT 9 GTL	APR9	AR9	PFG516K	
RENAULT	RENAULT: SYMBOL, CITIUS MEGAN	2010-2014	RENAULT: SYMBOL	AP0978	A3603	PFG405	
RENAULT	SANDERO DINAMIQUE Y EXPRESSION	2010- 2014	1.6 LTS	AP0978	A3603PLUS	PFG1195	AP31090
RENAULT	SANDERO STEPWAY	2014-2017	1.6 LTS	AP3554	A3603PLUS	PFG1195	AP31090
RENAULT	SCALA	2010-2012	1.6 LTS		A1402PLUS		
RENAULT	SCENIC	2001-2013	1.6 LTS	AP3554	A3603PLUS	PFG1195	
RENAULT	SCENIC I	1997	L4 1.4. 1.6 y 2.0Lt	AP3554	A3603PLUS	PFG1195	
RENAULT	SCENIC II	1999	L4 1.4. 1.6 y 2.0Lt	AP3561	A3603PLUS		
RENAULT	STIWAY	2015	1.6 LTS	AP3554	A3603PLUS		
RENAULT	SYMBOL	2001-2003	1.4 LTS	AP0978	A3603PLUS	PFG1195	AP31063
RENAULT	SYMBOL ALIZÉ	2006-2007	L4 1.6 Lt	AP3554	A3603PLUS	PFG405	AP31063
RENAULT	SYMBOL EXPRESSION, AUTHENTIC	2003-2007	L4 1.6 Lt	AP0978	A3603PLUS	PFG405	

MARCA	LÍNEA	AÑO	MOTOR	AIRE	ACEITE	COMBUSTIBLE	OTROS
RENAULT	TWINGO F1	1993-2007	L4 1.2 LTS	AP1294	A58PLUS / A3603PLUS		
RENAULT	TWINGO F2	2000-2014	L4 1.2 LTS	AP3709	PP6705	PFG1195	AP31090
RENAULT	TWINGO F3	2014-2016	L4 1.2 LTS	AP4439	A58PLUS		AP31090
RENAULT	TWINGO U	2006>	16 V	AP4439	A3603PLUS	PFG1195	
RENAULT	RENAULTL 4 / 6	1977>		AP3	AR46	PFG516K	
SEAT	ALTEA TFSI	2009-2015	1,8 LTS INY		A15403		
SEAT	LEON III TSI	2015-2018	1,8 LTS INY		PP6013Z		
SEAT	ATECA	2017-2023	1,4 LTS		A14302PLUS		
SEAT	ARONA	2019-2023	1,6 Lts		A14302PLUS		
SEAT	CORDOBA	2003-2009	1,6 Lts	AP31785	A223PLUS		
SEAT	TARRACO	2021	1,4 Lts		A223PLUS		
SEAT	IBIZA	2012-2020	1,6 LTS		A14302PLUS		
SEAT	IBIZA	2012-2020	1,6 LTS		PP80125		
SKODA	1 FABIA	1999- 2008	1.4 GASOLINA	AP35607	A223		
SKODA	FABIA	1999- 2008	1,6 LTS		PP80125		
SKODA	FABIA	2001-2003	L4 1.4lt	AP35786	A223PLUS		
SKODA	FABIA II	2007-2014	L4 1.4lt	AP35786	A223PLUS		
SKODA	FABIA III TSI	2014-2017	1.2 Lts		A223PLUS		
SKODA	FELICIA	1997-2001	1.3 Lts	AP2021	A223		
SKODA	FELICIA	1997-2001	1.6 Lts	AP2021	A223		
SKODA	OCTAVIA DRIVE	2006-2007	L4 1.6 y 2.0LT	AP35591	A223PLUS		
SKODA	OCTAVIA SLX	2002-2003	L4 1.8LT	AP35591	A223PLUS	PFG7958	
SKODA	SKODA FABIA	2008-2014	2.0 LTS	AP35786			
SKODA	SKODA TODOS.	1996	1.3 y 1.6 LTS	AP05120			
SKODA	SKODA Y OCTAVIA II FSI	2004-2008	1.6 LTS		PP80125		
SKODA	YETI MPI	2013-2017	1.6 Lts		A223PLUS		
SKODA	YETI TSI	2012-2018	1.8 Lts		A15403		
SSANGYONG	KORANDO	1996-1998	2.4	AP3554	PP40425		
SSANGYONG	KORANDO C	2011-2016	2.0 Gasolina	AP31857			
SSANGYONG	TIVOLI	2017>	1,6 LTS		A3603PLUS		
SUBARU	FORESTER III	2009-2012	2.5 LTS		A58PLUS		AP31081
SUBARU	FORESTER V	2019-2022	2.0 LTS		A1402PLUS		AP31138
SUBARU	IMPRESA V	2017-2022	2.0 LTS		A1402PLUS		AP31138
SUBARU	OUTBACK VI	2020-2022	2.4 LTS		A1402PLUS		AP31138
SUBARU	CROSSTREK	2020-2022	2.5 LTS		A1402PLUS		AP31138
SUBARU	ASCENT	2019-2022	2.4 LTS		A1402PLUS		AP31138
SUBARU	VIVIO	1992-1999	700 cc		A58	PFG805	
SUBARU	FORESTER AWD TURBO	2006	2.5lt	AP1312	A58PLUS / A1402PLUS		
SUBARU	EVOLTIS	2021-2022	2.4 LTS		A1402PLUS		AP31138

MARCA	LÍNEA	AÑO	MOTOR	AIRE	ACEITE	COMBUSTIBLE	OTROS
SUBARU	IMPREZA	2010-2015	2.0 LTS		A1402PLUS		
SUBARU	IMPREZA TRIBECA	2010-2015	2.5 LTS		A1402PLUS		AP31081
SUBARU	IMPREZA WRX TURBO AWD	2006	2.0Lt		A1402PLUS		
SUBARU	LEGACY	1994-2000	2.0 LTS		A73PLUS		
SUBARU	LEGACY	2005-2015	2.5 LTS		A58PLUS		AP31081
SUBARU	LEGACY R AWD SD TURBO	2001-2004	3.0 Lt	AP1312	A4056		
SUBARU	OUTBACK	2007-2015	2.5 LTS		A52		AP31081
SUBARU	OUTBACK AWD	1998-2004	2.5 - 3.0Lt		A58PLUS / A1402PLUS		AP31081
SUZUKI	SPRESSO	2020-2023	1.0 LTS		A14476PLUS		
SUZUKI	JIMNY	1998.2008	1.5 LTS		A14476PLUS		
SUZUKI	JIMNY	1998.2008	L4 1.3 LTS	AP31551	A1406PLUS	PFG25121074	
SUZUKI	ALTO	2012-2018	0.8 LTS		A14478PLUS		
SUZUKI	ALTO	2012-2018	0.8 LTS		A14476PLUS		
SUZUKI	ALTO	2012-2018	1.0 LTS		A14478PLUS		
SUZUKI	BALENO	2018-2022	1.4 LTS		A14476PLUS		
SUZUKI	XL7	2021-2022	1.5 LTS		A14476PLUS		
SUZUKI	CAMPEROS SUZUKI LJ-80.	1982	LJ 80	AP4041	A223		
SUZUKI	CELERIO	2013-2019	1.0 LTS		A14476PLUS		
SUZUKI	CIAZ	2015-2017	1.4 LTS	AP31905	A14476PLUS		
SUZUKI	ERTIGA	2013-2015	1.6 LTS	AP31905	A14476PLUS		
SUZUKI	GRAND VITARA	2016-2019	1.6 LTS	AP1312	A1406PLUS		
SUZUKI	GRAND VITARA SZ	2010-2015	1.6 LTS	AP3117	A1406PLUS		AP31026
SUZUKI	GRAND VITARA SZ	2010-2015	2.7 LTS	AP3117	A1406PLUS		AP31026
SUZUKI	IGNIS	2017-2018	1.2 LTS		A14476PLUS		
SUZUKI	KIZASHI	2013-2017	2.4 LTS	AP311001	A1406PLUS		
SUZUKI	S CROSS	2017-2022	1.6 LTS	AP1312	A1406PLUS		AP31070
SUZUKI	SX4 CROSSOVER	2008-2019	1.6 LTS	AP31984	A1406PLUS		
SUZUKI	SJ410	1981>	4 CILD CARB	AP410	A223		
SUZUKI	SJ413	1984>	4 CILD CARB	AP142	A223		
SUZUKI	SWIFT	2013-2016	1.0 LTS		A14478PLUS		
SUZUKI	SWIFT	2013-2016	1.2 LTS		A14478PLUS		
SUZUKI	SWIFT	2013-2016	1.4 LTS		A1406PLUS		
SUZUKI	SWIFT	2013-2016	1.4 LTS	AP31905	A14478PLUS		
SUZUKI	VITARA LIVE	2016-2023	1.6 LTS	AP1312	A1406PLUS		AP31070
SUZUKI	VITARA LIVE	2016-2023	1.4 LTS		A14476PLUS		AP31070
SUZUKI	VITARA SZ 2,4 LTS	2011-2019	2.4 LTS	AP31928	A1406PLUS		AP31026
TOYOTA	TOYOTA PRADO	1999-2002	2.7 LTS	AP58010	A14302PLUS		
TOYOTA	TOYOTA COROLLA CARBURA	1988- 1989	1,5 LTS 4 CLIND. CARB	AP31555	A14476		
TOYOTA	AVALON	2019-2021	3.5 LTS		PP31060		AP31138

MARCA	LÍNEA	AÑO	MOTOR	AIRE	ACEITE	COMBUSTIBLE	OTROS
TOYOTA	4 RUNNER	2010-2021	4000 cc		PP31060		AP31071
TOYOTA	4 RUNNER	2010-2021	4000 cc	AP3136	A14476PLUS		
TOYOTA	4 RUNNER	2010-2021	4CIL CARB	AP3134	A223	PFG805	
TOYOTA	4 RUNNER GASOLINA	2006-2010	4.0 Lts	AP3116	A223PLUS		
TOYOTA	4RUNNER LIMITED 06	2006-2009	4000 cc	AP3116	A14302PLUS		
TOYOTA	BURBUJA GASOLINA	1993-2006	4.5 Lts	AP1861	A1SP		
TOYOTA	CAMRY F.I.	1995-1999	2.2Lts	AP3135	A14476		
TOYOTA	CAMRY GASOLINA	1995-1999	2.2 Lts	AP3135	A14476		
TOYOTA	CAMRY GASOLINA	1995-1999	3.0 Lts	AP3135	A223		
TOYOTA	CELICA 2.0, CAMRY F.I. 2.2	2003	2.0 Lt. 2.2Lt	AP3135	A14476		
TOYOTA	COROLLA 1.8 LTS	2009-2019	1.8 LTS	AP31801	PP4024 / A14476		AP31071
TOYOTA	COROLLA	1993-2002	1.8 LTS	AP3133	A14476		
TOYOTA	COROLLA SE	2014-2015	1.8 LTS	AP31801	PP4024		AP31071
TOYOTA	COROLLA XE	2011-2019	1.8 LTS	AP31801	PP4024		AP31071
TOYOTA	CROWN	1995-1997	3.0 Lts GASOLINA	AP3179	A14476		
TOYOTA	FJ CRUISER	2008-2011	4		PP31060		
TOYOTA	FJ CRUISER	2008-2011	4	AP3116	A14302PLUS		
TOYOTA	FJ CRUISER AUT	2007-2009	4.0	AP1861	A1SP		
TOYOTA	FJ CRUISER SUPERCHARGED AUT	2008	4.0	AP1861	A1SP		
TOYOTA	FORTUNER	2008-2014	2.7	AP3116	A14302PLUS		AP31070
TOYOTA	FORTUNER SW4	2021>	4.0 LTS	AP35977	A14302PLUS	PFG420	AP31138
TOYOTA	FORTUNER 2.7	2017-2022	2,7 LTS	AP35977	A14302PLUS	PFG420	AP31071
TOYOTA	FZJ 73/74 GASOLINA	1994-2000	4.5 Lts	AP1861	A1SP		
TOYOTA	HIGHLANDER GASOLINA	2009-2010	3.3 Lts		A223PLUS		AP31071
TOYOTA	HILUX	2017-2021	2,7 LTS	AP35977	A14302PLUS	PFG420	AP31071
TOYOTA	HILUX	2010-2015	2.7 INJ	AP3116	A14302PLUS	PFG420	
TOYOTA	HILUX	1998-2000	2.4 lts	AP05113	A1SP	PFG1191	
TOYOTA	HILUX	1999-2000	3.0 INJ		A1SP		
TOYOTA	HILUX 4CIL INY	2001-2006	L4 2.4	AP62010	A1SP / A223PLUS		
TOYOTA	HILUX 4X2 Y 4X4	2004>	2.8 INJ		A1SP	PFG805	AP31071
TOYOTA	HILUX 4X2 Y 4X4	2004>	3.0 INJ	AP62010	A1SP		AP31071
TOYOTA	HILUX 4X4 DOB CABINA GASOLINA	2006-2007	2TR-FE 2700 cc	APC010	A223PLUS	PFG420	
TOYOTA	HILUX GASOLINA	2006-2016	2.7 INJ	APC010	A14302PLUS	PFG420	AP31071
TOYOTA	LAND CRUISER	1999-2008	4,5 INYECC	AP1861	A1SP		
TOYOTA	LAND CRUISER GASOLINA	2010-2018	4.0 Lts	AP3116	A14302PLUS	PFG420	

MARCA	LÍNEA	AÑO	MOTOR	AIRE	ACEITE	COMBUSTIBLE	OTROS
TOYOTA	LAND CRUISER GASOLINA	2010-2018	4.5 Lts	AP1861	A1SP / A223PLUS		
TOYOTA	LAND CRUISER GASOLINA	2010-2018	4.7 Lts INY	AP3134	A223PLUS		
TOYOTA	LAND CRUISER SERIE 70	2012-2015	4.1	AP3116	A14302PLUS	PFG420	
TOYOTA	LAND CRUISER 200 GASOLINA	2011-2018	4.6 Lts	AP31753	A223PLUS		AP31071
TOYOTA	LAND CRUISER PRADO VVTI	2010-2015	4.0 LTS		PP31060		AP31071
TOYOTA	NEW CAMRY V6 3,0 AUT	2006-2008	V6-3000		A223PLUS		
TOYOTA	NEW COROLLA SE, G AUT, MEC	2004-2009	L4 1.6 y (1.8Lt)	AP3133 / AP31528	A1406PLUS		
TOYOTA	NEW RAV 4 5P AUT-MEC ELITE	2006-2009	2.4 LTS		A1406PLUS		AP31071
TOYOTA	NUEVA HILUX D.C 4X2 D.X GASOLINA	2009-2010	2.5		A223PLUS		
TOYOTA	PRADO	1999-2008	3.0 LTS		A223PLUS		
TOYOTA	PRADO GX	1999-2004	2.7 LTS	AP62010	A14302PLUS		
TOYOTA	PRADO TX / TX-L	2010-2020	4.0 LTS		PP31060	PFG420	AP31071
TOYOTA	PRADO VX AUT-MEC 5P	1999-2009	3.4 LTS	AP62010	A14302PLUS		AP31081
TOYOTA	RAV 4	2016	2.0 LTS	AP31801	PP4024		AP31071
TOYOTA	RAV 4 2.0, 2.2	2001-2005	2.0. 2.2	AP3125	A14476PLUS		
TOYOTA	RAV 4 3P	1998-2006	2.0 LTS	AP3129	A1406PLUS		
TOYOTA	RAV 4 II	2001-2005	2.0 Y 2.4 LT	AP3125	A14476PLUS		
TOYOTA	RAV 4 III	2006-2013	2.5 LTS		PP31060		AP31071
TOYOTA	RAV 4	2020	2.0 LTS		A14476PLUS		AP31138
TOYOTA	RAV 4	2020	2.5 LTS		A14476PLUS		AP31138
TOYOTA	RAV4 3P FI	1998-2006	4-122 2.0L	AP3129	A14476PLUS		
TOYOTA	RUSH	2019-2021	2NR-VE 1,5 LTS	AP3113	A14476PLUS		
TOYOTA	SAHARA GASOLINA	2014-2018	5.7 Lts	AP31753			AP31071
TOYOTA	SAHARA GASOLINA	2014-2018	4.7 Lts INY	AP3134	A223		
TOYOTA	SEQUOIA	2000-2007	4.6 INJ	AP3134	A14302PLUS		
TOYOTA	SEQUOIA	2000-2007	5.7 INJ	AP31500	PP7406		AP31071
TOYOTA	SEQUOIA	2000-2007	4.7 Lts	AP31753	A223PLUS		
TOYOTA	SUPRA SEQUOIA	1993-1998	24V 3.0 INY	AP3134	A223PLUS		
TOYOTA	SW4 STREET	2018>	2,7 LTS	AP35977	A14302PLUS	PFG420	AP31071
TOYOTA	TACOMA	2015	3,5 CC	AP31500			
TOYOTA	TACOMA 3L5	1990 - 2006	4000 CC	AP3136	A14302PLUS	PFG423	
TOYOTA	TERCEL	1986-1996	1.3 Lts	AP3124	A14476		
TOYOTA	TERCEL	1986-1996	1.5 Lts. INY	AP3123	A14476		
TOYOTA	TOYOTA RAV 4	2000	2.0 LTS	AP31798	A14476		
TOYOTA	TOYOTA 4 RUNNER	1990-2004	3L4	AP3116	A14302PLUS	PFG423	

MARCA	LÍNEA	AÑO	MOTOR	AIRE	ACEITE	COMBUSTIBLE	OTROS
TOYOTA	TOYOTA COROLLA 1.3 MO	1993-2002	4 CLIND. INY	AP31592	A14476		
TOYOTA	TOYOTA COROLLA 1.8	2003>	1.8 /2.3 LTS 4 CLIND. INY	AP31628	A14476		
TOYOTA	TOYOTA HILUX 4*2,4*4.	1992-1996	4 CLIND. CARB	AP05113	A20		
TOYOTA	TOYOTA RUNNER 4	2002-2005	6 CIL. INY	AP3116	A14302PLUS		
TOYOTA	TOYOTA TERCEL	1997- 2000	4 CLIND. INY	AP3123	A18		
TOYOTA	TOYOTA TERCEL CARBURADOR	1986 - 1990	1,5 LTS 4 CLIND. CARB	AP3124	A14476		
TOYOTA	TOYOTA.	1969	4 CLIND. CARB	AP186		PGF516K	
TOYOTA	TUNDRA	2010-2013	5.7	AP31500	PP7406		AP31071
TOYOTA	TUNDRA	2010-2013	5.7	AP31753	PP7406		AP31071
TOYOTA	TUNDRA	2010-2013	5.7	AP31500	PP7406		AP31071
TOYOTA	TUNDRA	2010-2013	4.6	AP31500	PP7406		AP31071
TOYOTA	TUNDRA	2010-2013	4.6 Lts	AP31753	PP7406		AP31071
TOYOTA	TUNDRA	2010-2013	4.6 Lts	AP31753	PP7406		AP31071
TOYOTA	TUNDRA	2010-2013	4.7 Lts	AP31753	A223PLUS		
TOYOTA	TUNDRA	2010-2013	4.0 LtS	AP3116	A223PLUS		
TOYOTA	TUNDRA	2010-2013	4.0 LtS	AP31753	A223PLUS		
TOYOTA	TUNDRA	2010-2013	4.7 LtS	AP3134	A223PLUS		
TOYOTA	TUNDRA	2010-2013	4.6 LtS	AP31500	PP7406		AP31071
TOYOTA	TUNDRA	2010-2013	4.7 LtS	AP3134	A223PLUS		
TOYOTA	TUNDRA	2010-2013	4.0 LtS	AP3116 / AP31753	A223PLUS		AP31071
TOYOTA	TUNDRA	2010-2013	4.0 LtS	AP31753	PP31060 / A223PLUS		AP31071
TOYOTA	TUNDRA	2010-2013	4.0 LtS	AP31753	PP31060		AP31071
TOYOTA	TUNDRA	2010-2013	4.0 LtS	AP31500	PP31060		AP31071
TOYOTA	YARIS 1.3L	1999-2002	1.3	AP31653	A14476PLUS		
TOYOTA	YARIS 1500	2000-2004	1.5	AP31653	A14476PLUS		
TOYOTA	YARIS 1500	2000-2004	1.5	AP35644	PP4024		
TOYOTA	HIGHLANDER	2020-2021	3.5 LTS		PP6705		AP31138
VOLKSWAGEN	TRANSPORTER T4	1990-2009	DOHC, 2.0Lts, 100HP, 4 Cilindros	AP35758	PP15466		
VOLKSWAGEN	BORA 2.5	2006-2010	2.5	AP3538	PP7399		
VOLKSWAGEN	T-CROSS	2020>	1.6 LTS		A14302PLUS	PGG330	
VOLKSWAGEN	CROSS FOX	2010-2015	1.6 LTS	AP35786	A178SP		
VOLKSWAGEN	FOX 3P, 5P SPORT AA	2002-2006	1.0 y 1.6Lt	AP35786	A178SP		

MARCA	LÍNEA	AÑO	MOTOR	AIRE	ACEITE	COMBUSTIBLE	OTROS
VOLKSWAGEN	GOL	1997-2002	1.6 y 1.8Lt	AP35786	A178SP		
VOLKSWAGEN	ARTEON	2019-2022	2,0 LTS				
VOLKSWAGEN	NIVUS	2021-2022	1,0 LTS				
VOLKSWAGEN	GOL	1997-2002	1.6 LTS	AP35786	A223		
VOLKSWAGEN	GOL / CONFORLINE	2008-2016	1.6 LTS	AP35786	A178SP	PFG1195	
VOLKSWAGEN	GOL 3P	2001-2006	1.8 LTS	AP3527	A178SP		
VOLKSWAGEN	GOLF	2000-2010	2.0 LTS	AP35591	A178SP		
VOLKSWAGEN	VIRTUS	2019- 2021	1.6 LTS		A14302PLUS	PFG330	
VOLKSWAGEN	SAVEIRO	2013-2021	1.6 LTS	AP35786	A14302PLUS	PFG330	
VOLKSWAGEN	GOLF GTI	2015 2021	2.0 LTS		PP6013Z		
VOLKSWAGEN	GOLF GTI	2015 2021	2.0 LTS	AP35786 / AP3527	A178SP		
VOLKSWAGEN	TAOS	2021>	1.4 Lt		A14302PLUS	PFG330	
VOLKSWAGEN	JETTA	2011-2016	2.5 LTS	AP3538	PP7399		
VOLKSWAGEN	JETTA	2011-2016	2.0 LTS	AP35591	A178SP		
VOLKSWAGEN	JETTA	2011-2016	1,4 LTS		A14302PLUS		
VOLKSWAGEN	JETTA CONFORTLINE F.E	2005-2009	1.8 LTS	AP35665	A178SP		
VOLKSWAGEN	JETTA CONFORTLINE TIPTRONIC	2005-2009	1.8 LTS	AP35665	A178SP		
VOLKSWAGEN	JETTA GLI, TIPTRONIC	2009-2010	1.8 LTS		A178SP		
VOLKSWAGEN	JETTA TREDLINE	2011-2017	2.0 LTS		A15403		
VOLKSWAGEN	NEW BEETLE	2011-2015	2.5 LTS	AP3538	PP7399		
VOLKSWAGEN	NEWBEETLE TURBO	2000-2005	1.8 LTS	AP31785	A178PLUS		
VOLKSWAGEN	PASSAT CC T, HIGHLINE	2009-2010	2.0 LTS		PP7181		
VOLKSWAGEN	POLO	2000-2005	1.6 LTS	AP35786	A178SP	PFG1195	
VOLKSWAGEN	POLO HB,L,Sedan confort line	2003-2006	1.6 LTS	AP2021	A223PLUS		
VOLKSWAGEN	TIGUAN II TDI ALLSPACE	2016>	1,4 LTS		A14302PLUS		
VOLKSWAGEN	TIGUAN TREND Y FUN	2008-2010	2.0 LTS		A15403		

MARCA	LÍNEA	AÑO	MOTOR	AIRE	ACEITE	COMBUSTIBLE	OTROS
VOLKSWAGEN	VENTO	2014-2017	1.6 LTS				
VOLKSWAGEN	VOLKSWAGEN GOL	2000-2009	1,8 LTS	AP35793	A178SP		
VOLKSWAGEN	VOLKSWAGEN NEW BEETLE SPORT	2000-2005	1.8 LTS	AP35591	A178PLUS	PFG330	
VOLKSWAGEN	VOLKSWAGEN NEW BEETLE TURBO	2000-2005	1.8 TURBO	AP31785	A178PLUS	PFG330	
VOLKSWAGEN	VOLSKWAGEN FOX 2005	2005	1.0 LTS	AP3539P			
VOLKSWAGEN	VOYAGE	2012-2015	1.6 LTS	AP35786	A178SP		
VOLKSWAGEN	VOYAGE	2012-2015	1.6 LTS	AP35786	A14302PLUS	PFG330	
VOLKSWAGEN	JETTA	2011-2016	2.0 LTS		PP6013Z		
VOLKSWAGEN	TIGUAN II TDI	2018-2021	2.0 LTS		PP6013Z		
VOLVO	C30	2007-2009	1.8 Lts		A223PLUS	PFG330	
VOLVO	C30	2007-2009	2.0 Lts		A223PLUS	PFG330	
VOLVO	NEW S60 T5	2011-2016	2.0 LTS	AP35939	A223PLUS		
VOLVO	S40	2008-2014	2.0 Lts		A223PLUS		
VOLVO	V40 T4	2013-2017	1,6 LTS	AP35893	A223PLUS		
VOLVO	VOLVO XC60 NEW S60 T6	2011-2014	3.0 LTS	AP355344			AP33893
ZOTIE	ZOTIE NOMADA	2010>	1,3 Y 1,6 LTS	AP1202	A14476		



ES JUSTO
LO QUE NECESITAS



GUÍAS DE FILTRACIÓN - HIBRIDO



CO-SC-CER896120

MARCA	LÍNEA	AÑO	MOTOR	AIRE	ACEITE	COMBUSTIBLE	OTROS
KIA	SPORTAGE	2005-2008	1.6 LTS	AP31985		AS201SP	
MAZDA	CX30	2021>	2.0 LTS				
MITSUBISHI	OUTLANDER PHEV	2018-2022	2.0 LTS		A1402PLUS		
SUZUKI	SWIFT HIBRIDO	2022	1.2 LTS		A1406PLUS		
TOYOTA	COROLLA CROSS	2022	1.8 LTS		A14476PLUS		AP31071
TOYOTA	PRIUS	2016-2021	1.8 LTS		A14476PLUS		AP31138
TOYOTA	HIGHLANDER	2020-2021	2.5 LTS		A14476PLUS		AP31138



ES JUSTO

LO QUE NECESITAS



GUÍAS DE FILTRACIÓN - OTROS



CO-SC-CER896120

MARCA	LÍNEA	MOTOR	AIRE	ACEITE	COMBUSTIBLE	OTROS
ALLIS CHALMERS	ALLIS CHALMERS, COMBINADAS GL2	D210-220D	AP101234K			
ALLIS CHALMERS	ALLIS CHALMERS/ KOMATSU	D155A, D355A	APCA502 / APCA502SY			
ALLIS CHALMERS	ALLIS CHALMERS COMBINADAS, N7	COMBINADAS, N7		A3612ASP		
ALLIS CHALMERS	ALLIS CHALMERS; FORD; IHC; JOH	D15 -160 -5040	AP101275K			
ALLIS CHALMERS	JOHN DEERE: CARGADORES JD344E	JD344E	AP101275K		PM273	
ALLIS CHALMERS	TRACTORES ALLIS CHALMERS	7050 -7060			P3461	
ALLIS CHALMERS	TRACTORES ALLIS CHALMERS	200D			P3461	
ALLIS CHALMERS	TRACTORES ALLIS CHALMERS	160, 170, 175, 175G, 5040			P3461	
ATLAS COPCO	COMPRESORES	XAS210D, 230 ,XA120,XAS120,ST71DD, STS,PR425	AP41702 / AP41702SY			
ATLAS COPCO	COMPRESORES ST95D,STS95D	DEUTZ BF6L913	AP2291 / AP4091			
ATLAS COPCO	COMPRESORES,XAS175	J.DEERE 4045T	AP25867 / AP25867SY	A26SP		
BOBCAT	CARGADORES A220, S250	DEUTZ	AP3542 / AP3543	A14302PLUS	A11213DSP	
BOBCAT	CARGADORES 8646	DEUTZ	AP3542 / AP3543	A4046	A11213DSP	
BOBCAT	CARGADORES 853	ISUZU	AP101222K / AP2489	A2863SP	A11213DSP	
BOBCAT	CARGADORES	V3800DI-T		A20 / A20PLUS	A11213DSP	
BOBCAT	CARGADORES 863, 863G	ISUZU	AP3542 / AP3543	A2863SP	A11213DSP	
BOBCAT	CARGADORES S175	KUBOTA	AP101222K / AP2489	A20 / A20PLUS	A11213DSP	
BOBCAT	CARGADORES S185	KUBOTA INTERIM TIER 4		A20 / A20PLUS	A11213DSP	
BOBCAT	CARGADORES S183	KUBOTA	AP101222K / AP2489	A20 / A20PLUS	A11213DSP	
BOBCAT	CARGADORES S650 ,S630	KUBOTA V3307		A20 ó A9203	A11213DSP	
BOBCAT	CARGADORES 8300	TURBO	AP3542 / AP3543		A11213DSP	
BOBCAT	CARGADORES 763	KUBOTA	AP101222K / AP2489	A20 / A20PLUS	A11213DSP	
BOBCAT	CARGADORES 743	KUBOTA	AP101222K / AP2489	A20 / A20PLUS	P346P	
BOBCAT	CARGADORES	KUBOTA 334/335	AP3988	A20 / A20PLUS	A11213DSP	
CASE	CASE EQUIPOS PARA CONSTRUCCION	SERIE 580				
CASE	CASE SUPER	Super K.; 1845C /390	AP2360			
CASE	HUDSON, STUDEBAKER, ALLIS CHAL	CARGADORES 500 - 520			PM3	

MARCA	LÍNEA	MOTOR	AIRE	ACEITE	COMBUSTIBLE	OTROS
CASE	Tractores: 475, 850, 1030, 115	475, 850, 1030, 115	AP101246K			
CATERPILLAR	MONTACARGAS B20 , B25	CATERPILLAR			PM273	
CATERPILLAR	CARGADORES 955F, H , 933 ,951	CATERPILLAR	AP4M9378 / AP4M9379			
CATERPILLAR	BULLDOZERS D4D	M. CAT. 3304	AP4M9378 / AP4M9379			
CATERPILLAR	EXCAVADORAS 446B	CATERPILLAR	AP4M9378 / AP4M9379			
CATERPILLAR	CARGADORES 994,966, 963 , 955L ,944,939	CAT				PM9M9740
CATERPILLAR	BULLDOZERS D7E,D8E, D8F,D8N,D9E	CAT				PM9M9740
CATERPILLAR	EXCAVADORAS 225B-LC,229,225D LC	CAT 3304				PM9M9740
CATERPILLAR	EXCAVADORAS 225B-LC,229	CAT 3208				PM9M9740
CATERPILLAR	BULLDOZERS CAT VARIOS	D5E,D5H CAT. 3304				
CATERPILLAR	CARGADORES CATERPILLA	953, 943 MOTORES 3208		A9N5570SP		
CATERPILLAR	EXCAVADORAS 224B,M318,213B, 214B	CAT3116	AP25867 / AP25867SY	A67SP	A1P2299	
CATERPILLAR	EXCAVADORAS 320B	CAT 3066	AP3736 / AP3737	A67SP		
CATERPILLAR	EXCAVADORAS 320B, 320L, 322, 325B,	CAT.3116	AP3736 / AP3737	A67SP	A1R0751 / A7632	
CATERPILLAR	EXCAVADORAS 311 CATERPILLAR	320.320L,320N W/3066;		A7158SP		
CATERPILLAR	EXCAVADORES CATERPILLAR 320L	CATERPILLAR 3116T		A7158SP		
CATERPILLAR	EXCAVADORAS 330	CAT.3306	AP2216 / AP4416			
CATERPILLAR	MASSEY FERGUSON TRACTOR CARG	Mf20C; Mf30B		A50		
CATERPILLAR	MASSEY FERGUSON TRACTOR CARG	Mf20C; Mf30B		A50		
CATERPILLAR	MONTACARGAS V150, 155	MOTOR PERKINS		A7144SP		
CATERPILLAR	MOTORES INDUSTRIALES 3208T	CAT 3208	AP7N1225			
CATERPILLAR	Tractores D4, D5, D6; Excavadores 215, 227	D4 , D5, D6	AP4M8047 / AP4M8048			
CIM-TEK	COMBUSTIBLE SURTIDORES.	CIM-TEK			A915	
CIM-TEK	SURTIDORES CIM-TEK 70012-300-30	CIM-TEK 700 12 30 MICRAS	N/A		A70012SP	
CIM-TEK	SURTIDORES CIM-TEK 700 10	CIM-TEK 700 10 - 10 MICRAS	N/A		A70010	
CUMMINS	MOTORES,6CTA8.3	MAQUINARIA AMARILLA	AP25867 / AP25867SY	A339SP		
DETROIT DIESEL	MAQUINARIA Y AGRO	GMC			PM273	
FORD	TRACTORES	5100, 5200M. FORD	AP46530 / AP46531	A1SP	P346P	
GILBARCO	SURTIDORES GILBARCO, CIM-TEK 70016400-30	CIM-TEK 30 MICRAS	N/A		A70016SP	

MARCA	LÍNEA	MOTOR	AIRE	ACEITE	COMBUSTIBLE	OTROS
GILBARCO	SURTIDORES GILBARCO, CIM-TEK 4	CIM-TEK 10 MICRAS	N/A		A70015SP	
HAMM	COMPACTADORES HD10VV Y HD15VV	KUBOTA D1503-M-E3B		AR1218 / A9203	A11213DSP	
HITACHI	EX150,EX120-2,X160-5,UH053	ISUZU		A7144SP	A4053SP	
HITACHI	EXCAVADORA EX100-2,EX100-3,	4BD1 -4BD1		A7144SP	A4053SP	
HITACHI	EXCAVADORAS HITACHI SUPER 200		AP821883 / AP821884			
HITACHI	EXCAVADORAS HITACHI 20		AP4129907 / AP4129908			
HOLLMAN	MOTORES GF500		APC20500 / APC20500SY			
HYUNDAI	EQUIPOS HYUNDAI MAQUINARIA AGR	EQUIPOS HYUNDAI	AP87301			
INGERSOLL RAND	CPMPRESORES DXL900 ,DXL750,XL1100	GMC			PM273	
JBC	J.C.B. CARGADORES	215E, 530, 528-70, 530-70	AP3920 / AP3921			
JHON DEERE	CARGADORES VARIOS	JD455G J.DEERE		A91T1		
JOHN DEERE	RETROEXCAVADORA 310J/ 310K / 310SJ	PowerTech E 4045HT-4045H 4,5L	AP80006 / AP80006SY			
JOHN DEERE	CARGADORES JD144E	JD144E	AP2216 / AP4416			
JOHN DEERE	CUMMINS 3304232 , HINO, HITACHI ,J.DEERE	JCB260LC,		A777CSP		
JOHN DEERE	JOHN DEERE AR-58956. T-19044.	JOHN DEERE		A26SP		
JOHN DEERE	JOHN DEERE AR-58956. T-19044.	JOHN DEERE		A26SP		
JOHN DEERE	MOTOR - PLANTA ELECTRICA 41989	CUMM. 6CTA8.3	AP25867 / AP25867SY			
JOHN DEERE	TRACTORES	JD900HD / JD850 / JD950 / JD1050		A73		
JOHN DEERE	CARGADORES	ONAN		A243		
KOBELCO	AIRE KOBELCO 20		AP87657 / AP87658			
KOBELCO	RETROEXCAVADORAS KOBELCO	RETRO. KOBELCO		A7121SP		
KOMATSU	BULLDOZER	CUMM NH220			PM273	
KUBOTA	Tractores M105SHDC , series M8200, M9000	M8200, M9000	AP3544P / AP3545			
KUBOTA	TRACTORES L-295	KUBOTA		A243		
MASSEY FERGUSON	COMBINADA,MF760	MOTOR PERKINS	AP25867 / AP25867SY	AR17	P346P	
MASSEY FERGUSON	TRACTORES 8240, 8250, 8260	8240, 8250, 8260		A7133		
MASSEY FERGUSON	TRACTORES MASSEY FERGUSON, PER	TRACTORES MASSEY		PM813		
MASSEY FERGUSON	TRACTORES Y COMBINADAS MASSEY	MF296 PERKINS 6-354		AR17		
MASSEY FERGUSON	TRACTOR MF298	PERKINS	APC20500 / APC20500SY			
MITSUBISHI	FUSO FA 11,9	4D37 3,9 LTS EURO V	AP80006 / AP80006SY	A7028SP	AS1441SP	

MARCA	LÍNEA	MOTOR	AIRE	ACEITE	COMBUSTIBLE	OTROS
MITSUBISHI	MONTACARGAS MITSUBISHI FD40	M. DIESEL S6S		A7144SP	A033	
NEW HOLLAND	CARGADOR L175	N844T	AP101222K / AP2489	A14302PLUS	A11213DSP	
THERMOKING	MERCEDES-BENZ OM 636 / ISUZU C201	MERCEDES-BENZ OM 636 / ISUZU C201		A129SP		
THERMOKING	YANMAR TK486E / SB200 / SUPER II SR; SB III MAX	YANMAR TK486E / SB200 / SUPER II SR; SB III MAX		A7095		
THERMOKING	THERMO KING SB-100	ISUZU 4JC1		A7375SP		
THERMOKING	C201 DIESEL	C201 DIESEL		A309SP	A46 / A888 / A23L39	
THERMOKING	D122 DIESEL	D122 DIESEL		A309SP	A888	
THERMOKING	SB ISUZU FE / SL	SB ISUZU FE / SL		A28SP		
TOYOTA	MONTACARGAS	60-7FD25 / 62-7FD25		A113		
TOYOTA	MONTACARGAS	02-7FG30		A1406		
TOYOTA	MONTACARGAS	7FGCU20		A1406		
VOLVO	CARGADORES	4400,45 , L90, L90C	AP41702 / AP41702SY			
VOLVO	CARGADORES 4400,4500 , 4600 , A25 ,L160	VOLVO DIESEL	AP2291 / AP4091			
VOLVO	CARGADORES VOLVO Y BOLINDER 600	LM840 VOLVO			A48MC	
VOLVO	VOLVO EQUIPO DE CONSTRUCCION	VOLVO TD710 / VOLVO TAD73ES			A48MC	
VOLVO	CARGADORES D91-LBE2	L120E, L180E, L220E	AP2805			
VOLVO	VOLQUETAS DUMPERS	4400 / 861	AP41702 / AP41702SY			
YUCHAI	YUCHAI MOTOR 4105 ZUKAI COSECA	4105		A1DQ0001012011		



ES JUSTO

LO QUE NECESITAS

KITS DE APLIACIÓN SEGMENTO PESADO

**Vehículos de carga y pasajeros
mayor a 10 toneladas o más de 32 pasajeros**

**SOLUCIONES EN FILTRACIÓN
PARA TRANSPORTE MEDIANO**

HD / PESADO

ICONOS



CAMIONES SERIE F (FSR, FTR, FVR) 2006-2007 ISUZU 6HE1-TCS

AP5021 AIRE PRIMARIO	AP51250 AIRE SECUNDARIO	A205SP ACEITE	A7602 COMBUSTIBLE	PM1940 SEPARADOR AGUA COMBUSTIBLE	A1CSP SEPARADOR AGUA COMBUSTIBLE
D. Exterior 277.0 mm D. Interior 171 mm Altura 394 mm	D. Exterior 162 mm D. Interior 133.4 mm Altura 361.5 mm	D. Exterior 118.3 mm Rosca 1-1/2x12 in Altura 205 mm	D. Exterior 93.7 mm Rosca 3/4x16 in Altura 129 mm	D. Exterior 94.5 mm D. Interior 27.6 mm Altura 99 mm	D. Exterior 93.7 mm Rosca 3/4x16 in Altura 156 mm



FRR-FORWARD 2012-2014 ISUZU-4HK1-TCS 5.2 lts

AP14210 AIRE PRIMARIO	AP14220 AIRE SECUNDARIO	A7041SP ACEITE	PP28970 COMBUSTIBLE	PP24811 SEPARADOR AGUA COMBUSTIBLE
D. Exterior 232 mm D. Interior 132 mm Altura 370 mm	D. Exterior 132 mm D. Interior 95 mm Altura 350 mm	D. Exterior 118.3 mm Rosca 1-1/2x12 in Altura 155 mm	D. Exterior 89.4 mm D. Interior 12.1 mm Altura 114 mm	D. Exterior 104 mm D. Interior 28 mm Altura 192.6 mm



FSR CARGA 2013-2015 ISUZU 6HE1-TCS

AP3548 AIRE PRIMARIO	AP3722 AIRE SECUNDARIO	A205SP ACEITE	PP28970 COMBUSTIBLE	PP24811 SEPARADOR AGUA COMBUSTIBLE
D. Exterior 280 mm D. Interior 147 mm Altura 397 mm	D. Exterior 148 mm D. Interior 122 mm Altura 378 mm	D. Exterior 118.3 mm Rosca 1-1/2x12 in Altura 205 mm	D. Exterior 89.4 mm D. Interior 12.1 mm Altura 114 mm	D. Exterior 104 mm D. Interior 28 mm Altura 192.6 mm

HD / PESADO

ICONOS



FTR FORWARD 7.800cc 2012-2022 6HK1-TCN

AP14210 AIRE PRIMARIO	AP14220 AIRE SECUNDARIO	A205SP ACEITE	PP28970 COMBUSTIBLE	PP24811 SEPARADOR AGUA COMBUSTIBLE
D. Exterior 232 mm D. Interior 132 mm Altura 370 mm	D. Exterior 132 mm D. Interior 95 mm Altura 350 mm	D. Exterior 118.3 mm Rosca 1-1/2x12 in Altura 205 mm	D. Exterior 89.4 mm D. Interior 12.1 mm Altura 114 mm	D. Exterior 104 mm D. Interior 28 mm Altura 192.6 mm



FTR,FVR,FSR 2007-2011 ISUZU 7,2LT 250HP

AP5021 AIRE PRIMARIO	AP51250 AIRE SECUNDARIO	A205SP ACEITE	A7602 COMBUSTIBLE	PM1940 SEPARADOR AGUA COMBUSTIBLE	A1CSP SEPARADOR AGUA COMBUSTIBLE
D. Exterior 277.0 mm D. Interior 171 mm Altura 394 mm	D. Exterior 162 mm D. Interior 133.4 mm Altura 361.5 mm	D. Exterior 118.3 mm Rosca 1-1/2x12 in Altura 205 mm	D. Exterior 93.7 mm Rosca 3/4x16 in Altura 129 mm	D. Exterior 94.5 mm D. Interior 27.6 mm Altura 99 mm	D. Exterior 93.7 mm Rosca 3/4x16 in Altura 156 mm



KODIAK DIESEL 157, 211, 241 2004-2007 CAT 3116 Y 3126E

AP2863 AIRE PRIMARIO	AP3501 AIRE SECUNDARIO	A67SP ACEITE	PMX750R ACEITE	A1R0751SP COMBUSTIBLE	AS3202SP SEPARADOR AGUA COMBUSTIBLE	A5813SP SEPARADOR AGUA COMBUSTIBLE
D. Exterior 232 mm D. Interior 132 mm Altura 327 mm	D. Exterior 131 mm D. Interior 94.7 mm Altura 302.5 mm	D. Exterior 107.8 mm Rosca 1-1/8x16 in Altura 249 mm	D. Exterior 192 mm D. Interior 21.3 mm Altura 386.4 mm	D. Exterior 97.3 mm Rosca 7/8x14 in Altura 165 mm	D. Exterior 93.7 mm Rosca 1x12 in Altura 189 mm	D. Exterior 93.7 mm Rosca 1x12 in Altura 232 mm

HD / PESADO

ICONOS



KODIAK TANDEM 2006-2007 CAT 3126 ELEC

AP2863 AIRE PRIMARIO	AP3501 AIRE SECUNDARIO	A67SP ACEITE	PMX750R COMBUSTIBLE	A1R0751SP COMBUSTIBLE	A1212SP SEPARADOR AGUA COMBUSTIBLE
D. Exterior 277.0 mm D. Interior 171 mm Altura 394 mm	D. Exterior 162 mm D. Interior 133.4 mm Altura 361.5 mm	D. Exterior 118.3 mm Rosca 1-1/2x12 in Altura 205 mm	D. Exterior 192 mm D. Interior 21.3 mm Altura 386.4 mm	D. Exterior 93.7 mm Rosca 7/8x14 in Altura 165 mm	D. Exterior 93.7 mm Rosca 1x14 in Altura 192 mm



LV 452 BUS, CAMION EURO IV 2015- 2022 6WG1TC ISUZU

AP5213 AIRE PRIMARIO	AP5213SY AIRE SECUNDARIO	PM1650 ACEITE	PM2240 ACEITE	PM9760 COMBUSTIBLE	PP24811 (2) SEPARADOR AGUA COMBUSTIBLE
D. Exterior 332 mm D. Interior 175 mm Altura 424 mm	D. Exterior 175.6 mm D. Interior 149.8 mm Altura 389 mm	D. Exterior 104 mm D. Interior 48.9 mm Altura 185.8 mm	D. Exterior 128 mm D. Interior 25 mm Altura 196 mm	D. Exterior 100 mm D. Interior 14.7 mm Altura 162.4 mm	D. Exterior 104 mm D. Interior 28 mm Altura 192.6 mm



LV-150 BUS 2003-2012 ISZ 6WA1TC

AP5203 AIRE PRIMARIO	AP5217 AIRE SECUNDARIO	PM1650 ACEITE	PM2240 ACEITE	PM9760 COMBUSTIBLE	PM1940 SEPARADOR AGUA COMBUSTIBLE
D. Exterior 280 mm D. Interior 175 mm Altura 465 mm	D. Exterior 171 mm D. Interior 130 mm Altura 442 mm	D. Exterior 104 mm D. Interior 48.9 mm Altura 185.8 mm	D. Exterior 128 mm D. Interior 25 mm Altura 196 mm	D. Exterior 100 mm D. Interior 14.7 mm Altura 162.4 mm	D. Exterior 94.5 mm D. Interior 27.6 mm Altura 99 mm

HD / PESADO

ICONOS



Aire

Aceite

Combustible

Separador Agua Combustible

Aire Cabina

Hidráulico

Refrigerante

Transmisión

Secador de Aire



CARGO 1019 2019> CUMM. ISB 4,5 EURO V



	AP17308
	AIRE PRIMARIO
D. Exterior	1671 mm
D. Interior	109.8 mm
Altura	384.3 mm

	A7898SP
	ACEITE
D. Exterior	93.7 mm
Rosca	M27x2 mm
Altura	178 mm

	A7813SP
	COMBUSTIBLE
D. Exterior	93.7 mm
Rosca	M20x1.5
Altura	178 mm

	AS1249SP
	SEPARADOR AGUA COMBUSTIBLE
D. Exterior	93.7 mm
Rosca	1x14 in
Altura	168 mm



CARGO 1721 2003-2010 CUMM. 8,3 LTS



	AP5627
	AIRE PRIMARIO
D. Exterior	260 mm
D. Interior	146 mm
Altura	408 mm

	AP5628
	AIRE SECUNDARIO
D. Exterior	144 mm
D. Interior	111 mm
Altura	419 mm

	A3000SP
	ACEITE
D. Exterior	118.3 mm
Rosca	2-1/4x12 in
Altura	292 mm

	A243004SP
	COMBUSTIBLE
D. Exterior	81.3 mm
Rosca	M16x1.5 mm
Altura	125 mm

	AS1249SP
	SEPARADOR AGUA COMBUSTIBLE
D. Exterior	93.7 mm
Rosca	1x14 in
Altura	168 mm

	AW2010SP
	REFRIGERANTE
D. Exterior	93.7 mm
Rosca	11/16x16 in
Altura	129 mm



FORD CARGO 3129 2017-2019 CUMMINS ISB 6.7, 286HP, EURO V



	AP5627
	AIRE PRIMARIO
D. Exterior	260 mm
D. Interior	146 mm
Altura	408 mm

	AP5628
	AIRE SECUNDARIO
D. Exterior	144 mm
D. Interior	111 mm
Altura	419 mm

	A7898SP
	ACEITE
D. Exterior	93.7 mm
Rosca	M27x2 mm
Altura	178 mm

	A7813SP
	COMBUSTIBLE
D. Exterior	93.7 mm
Rosca	M20x1.5
Altura	178 mm

HD / PESADO

ICONOS



Aire

Aceite

Combustible

Separador Agua Combustible

Aire Cabina

Hidráulico

Refrigerante

Transmisión

Secador de Aire



AUMAN BJ 1133 I210 CTX 2011 CUMM. ISD 210 30



AP2291
AIRE PRIMARIO

D. Exterior	241 mm
D. Interior	133 mm
Altura	493 mm



A7898SP
ACEITE

D. Exterior	93.7 mm
Rosca	M27x2 mm
Altura	178 mm



A7813SP
COMBUSTIBLE

D. Exterior	93.7 mm
Rosca	M20x1.5 mm
Altura	178 mm



ASR90TDSP
SEPARADOR AGUA COMBUSTIBLE

D. Exterior	107.8 mm
Rosca	1X14 in
Altura	193.6 mm



FREIGHTLINER CASCADIA 2012> Motor DETROIT SERIE 60



A495SP (2)
ACEITE

D. Exterior	118.3 mm
Rosca	1-5/8x12 in
Altura	253 mm



A96
COMBUSTIBLE

D. Exterior	93.7 mm
Rosca	1x12 in
Altura	209 mm



A97SP
COMBUSTIBLE

D. Exterior	93.7 mm
Rosca	13/16x12 in
Altura	165 mm



AS5850SP
SEPARADOR AGUA COMBUSTIBLE

D. Exterior	107.8 mm
Rosca	1x14 in
Altura	161 mm



114SD VOLQUETA 2018> CUMM ISL 8.9 LTS 20 TON



A3000SP
ACEITE

D. Exterior	118.3 mm
Rosca	2-1/4x12 in
Altura	292 mm



A1SP
ACEITE

D. Exterior	93.7 mm
Rosca	3/4x16 in
Altura	139 mm



PM19765SP
COMBUSTIBLE

D. Exterior	106 mm
D. Interior	16.7 mm
Altura	181 mm



AP31036
AIRE CABINA

Alto	25 mm
Ancho	270 mm
Longitud	270 mm



AA5374
SECADOR DE FRENOS

D. Exterior	135 mm
Rosca	M39x1.5
Altura	164 mm

FOTON

KITS DE APLICACIÓN

FREIGHTLINER

HD / PESADO

ICONOS



CL 120 COLUMBIA 6X4 2005> DETROIT SERIE 60

AP3518 AIRE PRIMARIO	AP3518SY AIRE SECUNDARIO	A495SP (2) ACEITE	A97SP COMBUSTIBLE	A7301DSP SEPARADOR AGUA COMBUSTIBLE	AW5137SP REFRIGERANTE	AP31037 AIRE CABINA
D. Exterior 332 mm D. Interior 175 mm Altura 385 mm	D. Exterior 175.6 mm D. Interior 149.8 mm Altura 368.5 mm	D. Exterior 118.3 mm Rosca 1-5/8x12 in Altura 253 mm	D. Exterior 93.7 mm Rosca 13/16x12 in Altura 165 mm	D. Exterior 107.8 mm Rosca 1x14 in Altura 193 mm	D. Exterior 93.7 mm Rosca 11/16x16 in Altura 103 mm	Altura 25 mm Ancho 213 mm Longitud 219 mm



CL 120 COLUMBIA 6X4 1994-2004 DETROIT SERIE 60

AP2705 AIRE PRIMARIO	A495SP (2) ACEITE	A97SP COMBUSTIBLE	A5813SP SEPARADOR AGUA COMBUSTIBLE	AW2010SP REFRIGERANTE	AP31037 AIRE CABINA
D. Exterior 263.4 mm D. Interior 172.5 mm Altura 556 mm	D. Exterior 118.3 mm Rosca 1-5/8x12 in Altura 253 mm	D. Exterior 93.7 mm Rosca 13/16x12 in Altura 165 mm	D. Exterior 93.7 mm Rosca 1x12 in Altura 232 mm	D. Exterior 93.7 mm Rosca 11/16x16 in Altura 129 mm	Altura 25 mm Ancho 213 mm Longitud 219 mm



CLASSIC XL TRACTO CAMIÓN 2007 Motor CUMM. ISX 400ST

AP3539 AIRE PRIMARIO	A9080SP ACEITE	AS1040SP SEPARADOR AGUA COMBUSTIBLE	PM7680 SEPARADOR AGUA COMBUSTIBLE	AW2127SP REFRIGERANTE
D. Exterior 276 mm D. Interior 173 mm Altura 600 mm	D. Exterior 118.3 mm Rosca M95x2.5 Altura 302 mm	D. Exterior 118.3 mm Rosca M85x2 mm Altura 298 mm	D. Exterior 94.5 mm D. Interior 16.7 mm Altura 180.4 mm	D. Exterior 93.7 mm Rosca M36x2 mm Altura 146 mm

HD / PESADO

ICONOS



COLUMBIA CL 120 2005> CUMM. ISX 450

AP3518 AIRE PRIMARIO	AP3518SY AIRE SECUNDARIO	A9080SP ACEITE	AS1040SP SEPARADOR AGUA COMBUSTIBLE	PM19765SP SEPARADOR AGUA COMBUSTIBLE	AW2127SP REFRIGERANTE	AP31037 AIRE CABINA
D. Exterior 332 mm D. Interior 175 mm Altura 385 mm	D. Exterior 175.6 mm D. Interior 149.8 mm Altura 368.5 mm	D. Exterior 118.3 mm Rosca M95x2.5 mm Altura 302 mm	D. Exterior 118.3 mm Rosca M85x2 mm Altura 298 mm	D. Exterior 106 mm D. Interior 16.7 mm Altura 181 mm	D. Exterior 93.7 mm Rosca M36x2 mm Altura 146 mm	Altura 25 mm Ancho 213 mm Longitud 219 mm



FREIGHTLINER FLD 112 2000 CUMM. M-11

AP2705 AIRE PRIMARIO	A3000SP ACEITE	ASV1212SP SEPARADOR AGUA COMBUSTIBLE	AW5137SP REFRIGERANTE
D. Exterior 263.4 mm D. Interior 172.5 mm Altura 566 mm	D. Exterior 118.3 mm Rosca 2-1/4x12 in Altura 292 mm	D. Exterior 93.7 mm Rosca 1x14 in Altura 251 mm	D. Exterior 93.7 mm Rosca 11/16x16 in Alto 103 mm



FLD 120 DOBLE TROQUE 2005> CUMM. N14 PLUS

AP2705 AIRE PRIMARIO	A3000SP ACEITE	A23SP COMBUSTIBLE	ASV1212SP SEPARADOR AGUA COMBUSTIBLE	AW5137SP REFRIGERANTE
D. Exterior 263.4 mm D. Interior 172.5 mm Altura 566 mm	D. Exterior 118.3 mm Rosca 2-1/4x12 in Altura 292 mm	D. Exterior 93.7 mm Rosca 1x14 in Altura 166 mm	D. Exterior 93.7 mm Rosca 1x14 in Altura 251 mm	D. Exterior 93.7 mm Rosca 11/16x16 in Alto 103 mm

HD / PESADO

ICONOS



Aire



Aceite



Combustible



Separador Agua Combustible



Aire Cabina



Hidráulico



Refrigerante



Transmisión



Secador de Aire



M2 106 (PATINETA), BUSINESS CLASS 2005> MOTOR MBE900



PP9452
ACEITE

D. Exterior	80 mm
D. Interno	39.6 mm
Altura	213.4 mm



PP7735
COMBUSTIBLE

D. Exterior	91.7 mm
D. Interno	27.6 mm
Altura	100.5 mm



AP31036
AIRE CABINA

Altura	25 mm
Ancho	270 mm
Longitud	270 mm



HINO 500 FG81, FM81, GH81, GD1J 2015> J08E-UB 7.6Lts EURO IV



AP1325
AIRE PRIMARIO

D. Exterior	232 mm
D. Interior	123 mm
Altura	437 mm



AP1330E
AIRE SECUNDARIO

D. Exterior	108 mm
D. Interior	83 mm
Altura	411 mm



A7105SP
ACEITE

D. Exterior	118,3 mm
Rosca	1-1/2"x16
Altura	206 mm



A034L
COMBUSTIBLE

D. Exterior	81.3 mm
Rosca	3/4x16 in
Altura	103 mm



AS1441SP
SEPARADOR AGUA COMBUSTIBLE

D. Exterior	107.8 mm
Rosca	1x14 in
Altura	131 mm



BUS RK 1J 2005> J08C-TT 250HP



AP13190
AIRE PRIMARIO

D. Exterior	298.4 mm
D. Interior	190.8 mm
Altura	371 mm



AP13190SY
AIRE SECUNDARIO

D. Exterior	186 mm
D. Interior	156 mm
Altura	337 mm



A7105SP
ACEITE

D. Exterior	118,3 mm
Rosca	1-1/2"x16
Altura	206 mm



A034L
COMBUSTIBLE

D. Exterior	81.3 mm
Rosca	3/4x16 in
Altura	103 mm



AS1441SP
SEPARADOR AGUA COMBUSTIBLE

D. Exterior	107.8 mm
Rosca	1x14 in
Altura	131 mm

HD / PESADO

ICONOS



FG1626 - GH1826 SERIE 500 2015 J08E 7684

AP3518 AIRE PRIMARIO	AP3518SY AIRE SECUNDARIO	A9080SP ACEITE	AS1040SP SEPARADOR AGUA COMBUSTIBLE	PM19765SP SEPARADOR AGUA COMBUSTIBLE	AW2127SP REFRIGERANTE	AP31037 AIRE CABINA
D. Exterior 332 mm D. Interior 175 mm Altura 385 mm	D. Exterior 175.6 mm D. Interior 149.8 mm Altura 368.5 mm	D. Exterior 118.3 mm Rosca M95x2.5 mm Altura 302 mm	D. Exterior 118.3 mm Rosca M85x2 mm Altura 298 mm	D. Exterior 106 mm D. Interior 16.7 mm Altura 181 mm	D. Exterior 93.7 mm Rosca M36x2 mm Altura 146 mm	Altura 25 mm Ancho 213 mm Longitud 219 mm



GH8J 2021 J08C WP 7.7. LTS EURO V

AP1325 AIRE PRIMARIO	AP1330E AIRE SECUNDARIO	A7105SP ACEITE	PP11690SP COMBUSTIBLE	A23251SP COMBUSTIBLE	PM1730SP SEPARADOR AGUA COMBUSTIBLE
D. Exterior 232 mm D. Interior 123 mm Altura 437 mm	D. Exterior 108 mm D. Interior 83 mm Altura 411 mm	D. Exterior 118.3 mm Rosca 1-1/2x16 in Altura 206 mm	D. Exterior 89 mm D. Interior 24 mm Altura 139 mm	D. Exterior 107.8 mm Rosca 1-1/2x12 in Altura 204 mm	D. Exterior 94.5 mm D. Interior 27.6 mm Altura 193 mm



FM1A / SG1A MINI MULA 2019> A09 8.9 345 HP EURO IV

AP23030 AIRE PRIMARIO	AP23030SY AIRE SECUNDARIO	A7105SP ACEITE	PP11690SP COMBUSTIBLE	A23251SP COMBUSTIBLE	PM1730SP SEPARADOR AGUA COMBUSTIBLE
D. Exterior 280 mm D. Interior 147 mm Altura 379 mm	D. Exterior 149 mm D. Interior 120 mm Altura 362.5 mm	D. Exterior 118.3 mm Rosca 1-1/2x16 in Altura 206 mm	D. Exterior 89 mm D. Interior 24 mm Altura 139 mm	D. Exterior 107.8 mm Rosca 1-1/2x12 in Altura 204 mm	D. Exterior 94.5 mm D. Interior 27.6 mm Altura 193 mm

HINO

KITS DE APLICACIÓN

HD / PESADO

ICONOS



Aire



Aceite



Combustible



Separador Agua Combustible



Aire Cabina



Hidráulico



Refrigerante



Transmisión



Secador de Aire



SERIE 500 GH 2012-2014 EURO III 7.6 LTS



AP1325
AIRE PRIMARIO
D. Exterior 232 mm
D. Interior 123 mm
Altura 437 mm



AP1330E
AIRE SECUNDARIO
D. Exterior 108 mm
D. Interior 83 mm
Altura 411 mm



A7105SP
ACEITE
D. Exterior 118.3 mm
Rosca 1-1/2x16 in
Altura 206 mm



PP11690SP
COMBUSTIBLE
D. Exterior 89 mm
D. Interior 24 mm
Altura 139 mm



PM1730SP
SEPARADOR AGUA COMBUSTIBLE
Altura 94.5 mm
D. Interior 27.6 mm
Altura 193 mm



SERIE 700 FS1E 2007 HINO E13C 400HP



AP17845
AIRE PRIMARIO
D. Exterior 280 mm
D. Interior 175 mm
Altura 374 mm



AP17846
AIRE SECUNDARIO
D. Exterior 174 mm
D. Interior 130 mm
Altura 355 mm



PM1650
ACEITE
D. Exterior 104 mm
D. Interior 48.9 mm
Altura 185.8 mm



PM72281SP
ACEITE
D. Exterior 140 mm
D. Interior 17.5 mm
Altura 225.6 mm



A23SP
COMBUSTIBLE
D. Exterior 93.7 mm
Rosca 1x14 in
Altura 166 mm



PP202030
SEPARADOR AGUA COMBUSTIBLE
D. Exterior 111.5 mm
D. Interior 20.8 mm
Altura 244.8 mm



500 FG8J, GH8J, FM8J, GD8J, RK 2011-2022 J08E UB 7.7 LTS 247 HP EURO IV



AP1325
AIRE PRIMARIO
D. Exterior 232 mm
D. Interior 123 mm
Altura 437 mm



AP1330E
AIRE SECUNDARIO
D. Exterior 108 mm
D. Interior 83 mm
Altura 411 mm



A7105SP
ACEITE
D. Exterior 118.3 mm
Rosca 1-1/2x16 in
Altura 206 mm



A034L
COMBUSTIBLE
D. Exterior 81.3 mm
Rosca 3/4x16 in
Altura 139 mm



PP13110
SEPARADOR AGUA COMBUSTIBLE
D. Exterior 79.5 mm
D. Interior 17 mm
Altura 79.8 mm



PM1730SP
SEPARADOR AGUA COMBUSTIBLE
D. Exterior 94.5 mm
D. Interior 27.6 mm
Altura 193 mm

HINO

KITS DE APLICACIÓN

HD / PESADO

ICONOS



Aire



Aceite



Combustible



Separador Agua
Combustible



Aire Cabina



Hidráulico



Refrigerante



Transmisión



Secador
de Aire



HINO RK1J 2004-2015 J08C TT, 8.0 LTS 250 HP, 11 TON



AP23030
AIRE PRIMARIO

D. Exterior 280 mm
D. Interior 147 mm
Altura 379 mm



AP23030SY
AIRE SECUNDARIO

D. Exterior 149 mm
D. Interior 120 mm
Altura 362.5 mm



A7105SP
ACEITE

D. Exterior 118.3 mm
Rosca 1-1/2x16 in
Altura 206 mm



A034L
COMBUSTIBLE

D. Exterior 81.3 mm
Rosca 3/4x16 in
Altura 139 mm



PP13110
SEPARADOR AGUA
COMBUSTIBLE

D. Exterior 79.5 mm
D. Interior 17 mm
Altura 79.8 mm



AS1441SP
SEPARADOR AGUA
COMBUSTIBLE

D. Exterior 107.8 mm
Rosca 1x14 in
Altura 131 mm



HYUNDAI HD120 TURBO EURO III 2016> D6DA22



AP6A701
AIRE PRIMARIO

D. Exterior 268.8 mm
D. Interior 156.5 mm
Altura 333 mm



PP52001
ACEITE

D. Exterior 83.4 mm
D. Interior 29.6 mm
Altura 129 mm



A8000SP
COMBUSTIBLE

D. Exterior 81.3 mm
Rosca M20x1.5
Altura 101 mm



HD120 DOBLE TROQUE VOLQUETA EURO III 2008> D6DA19



AP6A701
AIRE PRIMARIO

D. Exterior 268.8 mm
D. Interior 156.5 mm
Altura 333 mm



A4317SP
ACEITE

D. Exterior 107.8 mm
Rosca M38x1.5
Altura 203 mm



A8000SP
COMBUSTIBLE

D. Exterior 81.3 mm
Rosca M20x1.5
Altura 101 mm

HINO

KITS DE APLICACIÓN

HYUNDAI

HD / PESADO

ICONOS



HD270 DOBLE TROQUE, MIXER 2012> D6CA38B

AP7C000 AIRE PRIMARIO	PM84001SP ACEITE	PM54236E ACEITE	A84040SP COMBUSTIBLE
D. Exterior 322 mm D. Interior 188 mm Altura 436 mm	D. Exterior 128 mm D. Interior 59 mm Altura 193 mm	D. Exterior 128 mm D. Interior 14.2 mm Altura 168 mm	D. Exterior 93.7 mm Rosca M22x1.5 Altura 178 mm



INTERNATIONAL 7300 WORKSTAR 2016 MAXX FORCE

AP4636 AIRE PRIMARIO	AP17846 AIRE SECUNDARIO	A9025SP ACEITE	PM19624SP COMBUSTIBLE	AP43042 AIRE CABINA
D. Exterior 260 mm D. Interior 164 mm Altura 405 mm	D. Exterior 203 mm D. Interior 128 mm Altura 380 mm	D. Exterior 118.3 mm Rosca M95x2 mm Altura 360mm	D. Exterior 95 mm D. Interior 16.7 mm Altura 180 mm	Altura 24 mm Ancho 181 mm Longitud 321 mm



INTERNATIONAL 7600I 2005-2022 CUMM. ISM 400

AP4862 AIRE PRIMARIO	AP4863 AIRE SECUNDARIO	A9080SP ACEITE	PM19624SP COMBUSTIBLE	AW5137SP REFRIGERANTE	PM1730SP AIRE CABINA
D. Exterior 303 mm D. Interior 195 mm Altura 406 mm	D. Exterior 253 mm D. Interior 170 mm Altura 390 mm	D. Exterior 118.3 mm Rosca M95x2.5 Altura 302 mm	D. Exterior 95 mm D. Interior 16.7 mm Altura 180 mm	D. Exterior 93.7 mm Rosca 11/16x16 in Altura 103 mm	Altura 24 mm Ancho 181 mm Longitud 321 mm

HYUNDAI

KITS DE APLICACIÓN

INTERNATIONAL

HD / PESADO

ICONOS



INTERNATIONAL 8600 TRANSTAR 2006 CUMM ISM

AP4862 AIRE PRIMARIO	AP4863 AIRE SECUNDARIO	A69SP ACEITE	PM19624SP COMBUSTIBLE	A614 COMBUSTIBLE	PM1730SP REFRIGERANTE
D. Exterior 303 mm D. Interior 195 mm Altura 406 mm	D. Exterior 253 mm D. Interior 170 mm Altura 390 mm	D. Exterior 136.5 mm Rosca 1-1/2x16 in Altura 289 mm	D. Exterior 95 mm D. Interior 16.7 mm Altura 180 mm	D. Exterior 93.7 mm D. Interior 1x14 in Altura 103 mm	D. Exterior 93.7 mm Rosca 11/16x16 in Altura 103 mm



INTERNATIONAL 9400I EAGLE 2005-2010 CUMM ISX 430

AP3518 AIRE PRIMARIO	AP3518SY AIRE SECUNDARIO	A9080SP ACEITE	AS1040SP SEPARADOR AGUA COMBUSTIBLE	PM7680 SEPARADOR AGUA COMBUSTIBLE	AW2127SP REFRIGERANTE
D. Exterior 332 mm D. Interior 175 mm Altura 385 mm	D. Exterior 175.6 mm D. Interior 149.8 mm Altura 368.5 mm	D. Exterior 118.3 mm Rosca M95x2.5 Altura 302 mm	D. Exterior 118.3 mm Rosca M85x2 mm Altura 298 mm	D. Exterior 94.5 mm D. Interior 16.7 mm Altura 180.4 mm	D. Exterior 93.7 mm Rosca M36x2 mm Altura 146 mm



Buses 3100 FE/SCD 4.8L DIESEL 2015> 4.8L /MAXFORCE EURO IV

AP3548 AIRE PRIMARIO	AP3722 AIRE SECUNDARIO	PP2620SP ACEITE	A1006SP COMBUSTIBLE	AS1249SP SEPARADOR AGUA COMBUSTIBLE
D. Exterior 280 mm D. Interior 147 mm Altura 397 mm	D. Exterior 148 mm D. Interior 122 mm Altura 378 mm	D. Exterior 94.8 mm D. Interior 44 mm Altura 161.4 mm	D. Exterior 93.7 mm Rosca 1x12 in Altura 211 mm	D. Exterior 93.7 mm Rosca 1x14 in Altura 168 mm

HD / PESADO

ICONOS



Aire

Aceite

Combustible

Separador Agua Combustible

Aire Cabina

Hidráulico

Refrigerante

Transmisión

Secador de Aire



INTERNATIONAL DOBLETROQUE 7400 6X4 2006-2009 DT-466

AP4636 AIRE PRIMARIO	AP4637 AIRE SECUNDARIO	A408SP ACEITE	A588SP COMBUSTIBLE	AW2010SP REFRIGERANTE	AP43042 AIRE CABINA
D. Exterior 260 mm D. Interior 164 mm Altura 405 mm	D. Exterior 203 mm D. Interior 128 mm Altura 380 mm	D. Exterior 136.5 mm Rosca M36x1.5 Altura 289 mm	D. Exterior 107.8 mm Rosca 7/8x14 in Altura 185 mm	D. Exterior 93.7 mm Rosca 11/16x16 in Altura 129 mm	Altura 24 mm Ancho 181 mm Longitud 321 mm



INTERNATIONAL SERIES 4300 2001-2018 IHC DT466E

AP4636 AIRE PRIMARIO	AP4637 AIRE SECUNDARIO	A408SP ACEITE	A588SP COMBUSTIBLE	A1345SP SEPARADOR AGUA COMBUSTIBLE	AP43042 AIRE CABINA
D. Exterior 260 mm D. Interior 164 mm Altura 405 mm	D. Exterior 203 mm D. Interior 128 mm Altura 380 mm	D. Exterior 136.5 mm Rosca M36x1.5 Altura 289 mm	D. Exterior 107.8 mm Rosca 7/8x14 in Altura 185 mm	D. Exterior 107.8 mm Rosca 1x14 in Altura 170 mm	Altura 24 mm Ancho 181 mm Longitud 321 mm



INTERNATIONAL EAGLE 9400 2006-> CUMM ISX 430

AP3518 AIRE PRIMARIO	AP3518SY AIRE SECUNDARIO	A9080SP ACEITE	AS1040SP SEPARADOR AGUA COMBUSTIBLE	PM7680 SEPARADOR AGUA COMBUSTIBLE	AW2127SP REFRIGERANTE
D. Exterior 332 mm D. Interior 175 mm Altura 385 mm	D. Exterior 175.6 mm D. Interior 149.8 mm Altura 368.5 mm	D. Exterior 118.3 mm Rosca M95x2.5 Altura 302 mm	D. Exterior 118.3 mm Rosca M85x2 mm Altura 298 mm	D. Exterior 94.5 mm D. Interior 16.7 mm Altura 180.4 mm	D. Exterior 93.7 mm Rosca M36x2 mm Altura 146 mm

INTERNATIONAL

KITS DE APLICACIÓN

HD / PESADO

ICONOS



INTERNATIONAL MINI MULA 4400 2005> IHC DT530

AP4636 AIRE PRIMARIO	AP4637 AIRE SECUNDARIO	A408SP ACEITE	A588SP COMBUSTIBLE	AS830SP SEP. AGUA COMBUSTIBLE	A1345SP SEP. AGUA COMBUSTIBLE	AW2010SP REFRIGERANTE	AP43042 AIRE CABINA
D. Exterior 260 mm D. Interior 164 mm Altura 405 mm	D. Exterior 203 mm D. Interior 128 mm Altura 380 mm	D. Exterior 136.5 mm Rosca M36x1.5 Altura 289 mm	D. Exterior 107.8 mm Rosca 7/8x14 Altura 185 mm	D. Exterior 107.8 mm Rosca 1x14 in Altura 130 mm	D. Exterior 107.8 mm Rosca 1x14 in Altura 170 mm	D. Exterior 93.7 mm Rosca 11/16x16 in Altura 129 mm	Altura 24 mm Ancho 181 mm Longitud 321 mm



INTERNATIONAL PAYSTAR 5600 2006 CUMM. ISX

AP3518 AIRE PRIMARIO	AP3518SY AIRE SECUNDARIO	A9080SP ACEITE	AS1040SP SEPARADOR AGUA COMBUSTIBLE	AS46018SP SEPARADOR AGUA COMBUSTIBLE	AW2127SP REFRIGERANTE
D. Exterior 332 mm D. Interior 175 mm Altura 385 mm	D. Exterior 175.6 mm D. Interior 149.8 mm Altura 368.5 mm	D. Exterior 118.3 mm Rosca M95x2.5 Altura 302 mm	D. Exterior 118.3 mm Rosca M85x2 mm Altura 298 mm	D. Exterior 107.8 mm Rosca 1x14 in Altura 216 mm	D. Exterior 93.7 mm Rosca M36x2 mm Altura 146 mm



INTERNATIONAL PROSTAR 2012> CUMM. ISX

AP4862 AIRE PRIMARIO	AP4863 AIRE SECUNDARIO	A9080SP ACEITE	AS1040SP SEPARADOR AGUA COMBUSTIBLE	PM19765SP SEPARADOR AGUA COMBUSTIBLE	AW2010SP REFRIGERANTE
D. Exterior 303 mm D. Interior 195 mm Altura 406 mm	D. Exterior 253 mm D. Interior 170 mm Altura 390 mm	D. Exterior 118.3 mm Rosca M95x2.5 Altura 302 mm	D. Exterior 118.3 mm Rosca M85x2 mm Altura 298 mm	D. Exterior 106 mm D. Interior 16.7 mm Altura 181 mm	D. Exterior 93.7 mm Rosca 11/16x16 in Altura 129 mm

HD / PESADO

ICONOS



INTERNATIONAL SERIE 7400 CAMION 2004 -> IHC DT530, DT570

AP4636 AIRE PRIMARIO	AP4637 AIRE SECUNDARIO	A408SP ACEITE	A588SP COMBUSTIBLE	AS830SP SEPARADOR AGUA COMBUSTIBLE	A1345SP SEPARADOR AGUA COMBUSTIBLE	AP43042 AIRE CABINA
D. Exterior 260 mm D. Interior 164 mm Altura 405 mm	D. Exterior 203 mm D. Interior 128 mm Altura 380 mm	D. Exterior 136.5 mm Rosca M36x1.5 mm Altura 289 mm	D. Exterior 107.8 mm Rosca 7/8x14 in Altura 185 mm	D. Exterior 107.8 mm Rosca 1x14 in Altura 130 mm	D. Exterior 107.8 mm Rosca 1x14 in Altura 170 mm	Altura 24 mm Ancho 181 mm Longitud 321 mm



INTERNATIONAL TRACTO CAMION 99001 2000-2013 CUMM. ISX 15

AP3518 AIRE PRIMARIO	AP3518SY AIRE SECUNDARIO	A9080SP ACEITE	AS1040SP SEPARADOR AGUA COMBUSTIBLE	PM7680 SEPARADOR AGUA COMBUSTIBLE	PM19765SP SEPARADOR AGUA COMBUSTIBLE	AW2127SP REFRIGERANTE
D. Exterior 332 mm D. Interior 175 mm Altura 385 mm	D. Exterior 175.6 mm D. Interior 149.8 mm Altura 368.5 mm	D. Exterior 118.3 mm Rosca M95x2.5 mm Altura 302 mm	D. Exterior 118.3 mm Rosca 7/8x14 in Altura 185 mm	D. Exterior 94.5 mm D. Interior 16.7 mm Altura 180.4 mm	D. Exterior 106 mm D. Interior 16.7 mm Altura 181 mm	D. Exterior 93.7 mm Rosca M36x2 mm Altura 146 mm



INTERNATIONAL VOLQUETA - CHASIS 7600 6X4 2008-2009 CUMM. M11

AP4862 AIRE PRIMARIO	AP4863 AIRE SECUNDARIO	A3000SP ACEITE	A1259SP SEPARADOR AGUA COMBUSTIBLE	AP43042 AIRE CABINA
D. Exterior 303 mm D. Interior 195 mm Altura 406 mm	D. Exterior 253 mm D. Interior 170 mm Altura 390 mm	D. Exterior 118.3 mm Rosca 2-1/4x12 in Altura 292 mm	D. Exterior 93.7 mm Rosca 1x14 in Altura 251 mm	Altura 24 mm Ancho 181 mm Longitud 321 mm

INTERNATIONAL

KITS DE APLICACIÓN

INTERNATIONAL

KITS DE APLICACIÓN

IVECO

JAC

HD / PESADO

ICONOS



INTERNATIONAL VOLQUETA CAREGATO 7600 2005> CUMM. ISX

AP4862 AIRE PRIMARIO	AP4863 AIRE SECUNDARIO	A9080SP ACEITE	PM7680 SEPARADOR AGUA COMBUSTIBLE	AW2127SP REFRIGERANTE	AP43042 AIRE CABINA
D. Exterior 303 mm D. Interior 195 mm Altura 406 mm	D. Exterior 253 mm D. Interior 170 mm Altura 390 mm	D. Exterior 118.3 mm Rosca M95x2.5 Altura 302 mm	D. Exterior 94.5 mm D. Interior 16.7 mm Altura 180.4 mm	D. Exterior 93.7 mm Rosca M36x2 mm Altura 146 mm	Altura 24 mm Ancho 181 mm Longitud 321 mm



IVECO 170 E 22 CAMION 2001 TECTOR 235HP

AP41702 AIRE PRIMARIO	AP41702SY AIRE SECUNDARIO	A7898SP ACEITE	A7813SP COMBUSTIBLE
D. Exterior 228.5 mm D. Interior 116 mm Altura 372.2 mm	D. Exterior 105 mm D. Interior 98 mm Altura 380 mm	D. Exterior 118.3 mm Rosca M95x2.5 Altura 302 mm	D. Exterior 93.7 mm Rosca M20x1.5 Altura 178 mm



JAC CAMION 1131 2007> MOTOR CUMMINS

AP2211 AIRE PRIMARIO	A3000SP ACEITE	A243004SP COMBUSTIBLE	A1259SP SEPARADOR AGUA COMBUSTIBLE
D. Exterior 298.4 mm D. Interior 190.8 mm Altura 390 mm	D. Exterior 118.3 mm Rosca 2-1/4x12 in Altura 292 mm	D. Exterior 81.3 mm Rosca M16x1.5 mm Altura 125 mm	D. Exterior 93.7 mm Rosca 1x14 in Altura 251 mm

HD / PESADO

ICONOS



KENWORTH T2000W 2004 CUMM. N14

AP3548 AIRE PRIMARIO	AP3722 AIRE SECUNDARIO	A3000SP ACEITE	ASV1212SP SEPARADOR AGUA COMBUSTIBLE
D. Exterior 280 mm D. Interior 147 mm Altura 397 mm	D. Exterior 148 mm D. Interior 122 mm Altura 378 mm	D. Exterior 118.3 mm Rosca 2-1/4x12 in Altura 292 mm	D. Exterior 93.7 mm Rosca 1x14 in Altura 251 mm



KENWORTH T300 2007-> CUMM. 8.3L

AP2863 AIRE PRIMARIO	A3000SP ACEITE	A243004 COMBUSTIBLE	A43SP SEPARADOR AGUA COMBUSTIBLE
D. Exterior 232 mm D. Interior 132 mm Altura 327 mm	D. Exterior 118.3 mm Rosca 2-1/4x12 in Altura 292 mm	D. Exterior 81.3 mm Rosca M16x1.5 mm Altura 125 mm	D. Exterior 93.7 mm Rosca 13/16x18 in Altura 156 mm



KENWORTH T300 2006-> CUMMINS ISC

AP2863 AIRE PRIMARIO	AP3501 AIRE SECUNDARIO	A3000SP ACEITE	A588SP COMBUSTIBLE	AS1003SP SEPARADOR AGUA COMBUSTIBLE	AW2010SP REFRIGERANTE
D. Exterior 232 mm D. Interior 132 mm Altura 327 mm	D. Exterior 131 mm D. Interior 94.7 mm Altura 302.5 mm	D. Exterior 118.3 mm Rosca 2-1/4x12 in Altura 292 mm	D. Exterior 107.8 mm Rosca 7/8x14 in Altura 185 mm	D. Exterior 93.7 mm Rosca 1x14 in Altura 258 mm	D. Exterior 93.7 mm Rosca 11/16x16 in Altura 129 mm

HD / PESADO

ICONOS

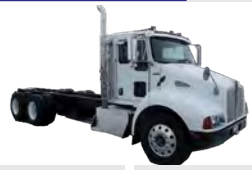

KENWORTH T300 DOBLETROQUE 2006-> CUMM. ISC 300

AP2863 AIRE PRIMARIO	AP3501 AIRE SECUNDARIO	A3000SP ACEITE	A888 COMBUSTIBLE	AS1003SP SEPARADOR AGUA COMBUSTIBLE	AW2010SP REFRIGERANTE
D. Exterior 232 mm D. Interior 132 mm Altura 327 mm	D. Exterior 131 mm D. Interior 94.7 mm Altura 302.5 mm	D. Exterior 118.3 mm Rosca 2-1/4x12 in Altura 292 mm	D. Exterior 93.7 mm Rosca 7/8x14 in Altura 205 mm	D. Exterior 93.7 mm Rosca 1x14 in Altura 258 mm	D. Exterior 93.7 mm Rosca 11/16x16 in Altura 129 mm



KENWORTH T300 DOBLETROQUE 2007-> CUMM. ISB

AP2863 AIRE PRIMARIO	A339SP ACEITE	A23SP COMBUSTIBLE	AW2010SP REFRIGERANTE
D. Exterior 232 mm D. Interior 132 mm Altura 327 mm	D. Exterior 93.7 mm Rosca 1x16 in Altura 165 mm	D. Exterior 93.7 mm Rosca 1x14 in Altura 166 mm	D. Exterior 93.7 mm Rosca 11/16x16 in Altura 129 mm



KENWORTH T800 BAJO CAPOT RANCHERA 2011> CUMM. ISX

A9080SP ACEITE	AS1040SP SEPARADOR AGUA COMBUSTIBLE	AW2127SP REFRIGERANTE
D. Exterior 118.3 mm D. Interior M95x2.5 Altura 302 mm	D. Exterior 118.3 mm Rosca M85x2 mm Altura 298 mm	D. Exterior 93.7 mm Rosca M36x2 mm Altura 146 mm

HD / PESADO

ICONOS



KENWORTH T800 BAJO CAPOT 2000-2010 CUMM. ISX 450

AP2705 AIRE PRIMARIO	A9080SP ACEITE	AS1040SP SEPARADOR AGUA COMBUSTIBLE	PM19765SP SEPARADOR AGUA COMBUSTIBLE
D. Exterior 263.4 mm D. Interior 172.5 mm Altura 566 mm	D. Exterior 118.3 mm D. Interior M95x2.5 mm Altura 302 mm	D. Exterior 118.3 mm Rosca M85x2 mm Altura 298 mm	D. Exterior 106 mm D. Interior 16.7 mm Altura 181 mm



KENWORTH T800 RANCHERA 1996-1999 CAT C15

AP3539 (2) AIRE PRIMARIO	A69SP ACEITE	A614 COMBUSTIBLE	A1259SP SEPARADOR AGUA COMBUSTIBLE	AW5137SP REFRIGERANTE
D. Exterior 276 mm D. Interior 173 mm Altura 600 mm	D. Exterior 136.5 mm Rosca 1-1/2x16 in Altura 289 mm	D. Exterior 93.7 mm Rosca 1x14 in Altura 266 mm	D. Exterior 93.7 mm Rosca 1x14 in Altura 251 mm	D. Exterior 93.7 mm Rosca 11/16x16 in Altura 103 mm



KENWORTH T800 RANCHERA AMERICANA 15" 2000-2010 CUMM ISX 450

A9080SP ACEITE	AS1040SP SEPARADOR AGUA COMBUSTIBLE	PM7680 SEPARADOR AGUA COMBUSTIBLE	AW2127SP REFRIGERANTE
D. Exterior 118.3 mm Rosca M95x2.5 Altura 302 mm	D. Exterior 118.3 mm Rosca M85x2 mm Altura 298 mm	D. Exterior 94.5 mm D. Interior 16.7 mm Altura 180.4 mm	D. Exterior 93.7 mm Rosca M36x2 mm Altura 146 mm

HD / PESADO

ICONOS



T800 RANCHERA AMERICANA 13" 2000-2010 CUMM ISX 400

AP3539 (2) AIRE PRIMARIO	A9080SP ACEITE	AS1040SP SEPARADOR AGUA COMBUSTIBLE	PM19765SP SEPARADOR AGUA COMBUSTIBLE	AW2127SP REFRIGERANTE	AP43100 AIRE CABINA
D. Exterior 276 mm D. Interior 173 mm Altura 600 mm	D. Exterior 118.3 mm Rosca M95x2.5 Altura 302 mm	D. Exterior 118.3 mm Rosca M85x2 mm Altura 298 mm	D. Exterior 106 mm D. Interior 16.7 mm Altura 181 mm	D. Exterior 93.7 mm Rosca 11/16x16 in Altura 129 mm	Altura 28 mm Ancho 198 mm Longitud 228 mm



KENWORTH T800 TRACTO CAMIÓN 1996-1999 CUMM. ISM

AP3539 (2) AIRE PRIMARIO	A9080SP ACEITE	A7766SP COMBUSTIBLE	A23SP COMBUSTIBLE	AS1040SP SEPARADOR AGUA COMBUSTIBLE	AW5137SP REFRIGERANTE
D. Exterior 276 mm D. Interior 173 mm Altura 600 mm	D. Exterior 118.3 mm Rosca M95x2.5 Altura 302 mm	D. Exterior 93.7 mm D. Interior M72x2 mm Altura 232 mm	D. Exterior 93.7 mm Rosca 1x14 in Altura 166 mm	D. Exterior 118.3 mm Rosca M85x2 mm Altura 298 mm	D. Exterior 93.7 mm Rosca 11/16x16 in Altura 103 mm



KENWORTH TRACTO CAMION RANCHERA 13" 2010> CUMM. ISX

AP4986 AIRE PRIMARIO	A9080SP ACEITE	AS1040SP SEPARADOR AGUA COMBUSTIBLE	AW2127SP REFRIGERANTE	AP43100 AIRE CABINA
D. Exterior 288 mm D. Interior 172 mm Altura 609 mm	D. Exterior 118.3 mm Rosca M95x2.5 Altura 302 mm	D. Exterior 118.3 mm Rosca M85x2 mm Altura 298 mm	D. Exterior 93.7 mm Rosca 11/16x16 in Altura 129 mm	Altura 28 mm Ancho 198 mm Longitud 228 mm

HD / PESADO

ICONOS



Aire

Aceite

Combustible

Separador Agua Combustible

Aire Cabina

Hidráulico

Refrigerante

Transmisión

Secador de Aire



MACK CAMIÓN CX-613 VISION 2004 Motor E-7 355 E-TECH



AP2680
AIRE PRIMARIO

D. Exterior 263.4 mm
D. Interior 172.5 mm
Altura 722 mm

AP3936
AIRE SECUNDARIO

D. Exterior 235 mm
D. Interior 147 mm
Altura 648 mm

A67SP
ACEITE

D. Exterior 107.8 mm
Rosca 1-1/8x16 in
Altura 249 mm

A7656E
COMBUSTIBLE

D. Exterior 107.8 mm
Rosca M22x1.5
Altura 195 mm

A7657
COMBUSTIBLE

D. Exterior 107.8 mm
Rosca M30x1.5
Altura 263 mm

AW475SP
REFRIGERANTE

D. Exterior 93.7 mm
Rosca 3/4x20 in
Altura 129 mm



MACK CH613, RD690S CX613 2000 E7-454



AP57MD33
AIRE PRIMARIO

D. Exterior 322 mm
D. Interior 212 mm
Altura 585 mm

A67SP
ACEITE

D. Exterior 107.8 mm
Rosca 1-1/8x16 in
Altura 249 mm

A30SP
COMBUSTIBLE

D. Exterior 107.8 mm
Rosca 7/8x16 in
Altura 185 mm

A31SP
COMBUSTIBLE

D. Exterior 107.8 mm
Rosca 13/16x18 in
Altura 185 mm

AW475SP
REFRIGERANTE

D. Exterior 93.7 mm
Rosca 3/4x20 in
Altura 129 mm



MACK CH613, TRACTO CAMIÓN DIÉSEL 2000 E7-350



AP2680
AIRE PRIMARIO

D. Exterior 263.4 mm
D. Interior 172.5 mm
Altura 722 mm

A67SP
ACEITE

D. Exterior 107.8 mm
Rosca 1-1/8x16 in
Altura 249 mm

A150F
COMBUSTIBLE

D. Exterior 107.8 mm
Rosca 1-1/16"x16 in
Altura 248.2 mm

A31SP
COMBUSTIBLE

D. Exterior 107.8 mm
Rosca 13/16x18 in
Altura 185 mm

AW475SP
REFRIGERANTE

D. Exterior 93.7 mm
Rosca 3/4x20 in
Altura 129 mm

MACK

KITS DE APLICACIÓN

HD / PESADO

ICONOS



Aire

Aceite

Combustible

Separador Agua Combustible

Aire Cabina

Hidráulico

Refrigerante

Transmisión

Secador de Aire



MACK CV713 D-TROQUE GRANITE 427 2004 > E7-427 E-TECH ELEC



AP2680
AIRE PRIMARIO

D. Exterior	263.4 mm
D. Interior	172.5 mm
Altura	722 mm

A67SP (2)
ACEITE

D. Exterior	107.8 mm
Rosca	1-1/8x16 in
Altura	249 mm

A7656E
COMBUSTIBLE

D. Exterior	107.8 mm
Rosca	M22x1.5
Altura	195 mm

A7657
COMBUSTIBLE

D. Exterior	107.8 mm
Rosca	M30x1.5
Altura	263 mm

AW475SP
REFRIGERANTE

D. Exterior	93.7 mm
Rosca	3/4x20 in
Altura	129 mm



MACK CV713 D-TROQUE GRANITE 350-380 2004 > E7-350, 380 E-TECH



AP2680
AIRE PRIMARIO

D. Exterior	263.4 mm
D. Interior	172.5 mm
Altura	722 mm

AP3936
AIRE SECUNDARIO

D. Exterior	235 mm
D. Interior	147 mm
Altura	648 mm

A67SP
ACEITE

D. Exterior	107.8 mm
Rosca	1-1/8x16 in
Altura	249 mm

A7656E
COMBUSTIBLE

D. Exterior	107.8 mm
Rosca	M22x1.5
Altura	195 mm

A7657
COMBUSTIBLE

D. Exterior	107.8 mm
Rosca	M30x1.5
Altura	263 mm

AW475SP
REFRIGERANTE

D. Exterior	93.7 mm
Rosca	3/4x20 in
Altura	129 mm



MACK GRANITE 2004 DIÉSEL AMI370



AP2680
AIRE PRIMARIO

D. Exterior	263.4 mm
D. Interior	172.5 mm
Altura	722 mm

A67SP
ACEITE

D. Exterior	107.8 mm
Rosca	1-1/8x16 in
Altura	249 mm

A7685SP
ACEITE

D. Exterior	107.8 mm
Rosca	1-3/8x16 in
Altura	257 mm

A8059
COMBUSTIBLE

D. Exterior	107.8 mm
Rosca	M32x1.5
Altura	263 mm

PP202030
SEPARADOR AGUA COMBUSTIBLE

D. Exterior	111.5 mm
D. Interior	20.8 mm
Altura	244.8 mm

MACK

KITS DE APLICACIÓN

HD / PESADO

ICONOS



Aire

Aceite

Combustible

Separador Agua Combustible

Aire Cabina

Hidráulico

Refrigerante

Transmisión

Secador de Aire



MACK GRANITE 2013 CHU612 MP8



AP3936
AIRE PRIMARIO

D. Exterior 235 mm
D. Interior 147 mm
Altura 648 mm

A67SP
ACEITE

D. Exterior 107.8 mm
Rosca 1-1/8x16 in
Altura 249 mm

A7685SP
ACEITE

D. Exterior 107.8 mm
Rosca 1-3/8x16 in
Altura 257 mm

A8059
COMBUSTIBLE

D. Exterior 107.8 mm
Rosca M32x1.5
Altura 263 mm

PP202030
SEPARADOR AGUA COMBUSTIBLE

D. Exterior 111.5 mm
D. Interior 20.8 mm
Altura 244.8 mm



MACK CH613, RD690S CX613 2000 E7-454



AP57MD33
AIRE PRIMARIO

D. Exterior 322 mm
D. Interior 212 mm
Altura 585 mm

A67SP
ACEITE

D. Exterior 107.8 mm
Rosca 1-1/8x16 in
Altura 249 mm

A30SP
COMBUSTIBLE

D. Exterior 107.8 mm
Rosca 7/8x16 in
Altura 185 mm

A31SP
COMBUSTIBLE

D. Exterior 107.8 mm
Rosca 13/16x18 in
Altura 185 mm

AW475SP
REFRIGERANTE

D. Exterior 93.7 mm
Rosca 3/4x20 in
Altura 129 mm



MACK VISION 2012 > MACK MP8 12.8 LTS



AP3936
AIRE PRIMARIO

D. Exterior 235 mm
D. Interior 147 mm
Altura 648 mm

A67SP (2)
ACEITE

D. Exterior 107.8 mm
Rosca 1-1/8x16 in
Altura 249 mm

A7656E
COMBUSTIBLE

D. Exterior 107.8 mm
Rosca M22x1.5
Altura 195 mm

A7657
COMBUSTIBLE

D. Exterior 107.8 mm
Rosca M30x1.5
Altura 263 mm

AW475SP
REFRIGERANTE

D. Exterior 93.7 mm
Rosca 3/4x20 in
Altura 129 mm

HD / PESADO

ICONOS



Aire



Aceite



Combustible



Separador Agua
Combustible



Aire Cabina



Hidráulico



Refrigerante



Transmisión



Secador
de Aire



MERCEDES BENZ ACTROS 3332K 2019-2021 OM-501LA 11,9 LTS



AP84457
AIRE PRIMARIO

D. Exterior	266 mm
D. Interior	168 mm
Altura	490 mm



AP84457SY
AIRE SECUNDARIO

D. Exterior	155 mm
D. Interior	137 mm
Altura	509 mm



AS46018SP
SEPARADOR AGUA
COMBUSTIBLE

D. Exterior	107.8 mm
Rosca	1x14 in
Altura	216 mm



MERCEDES BENZ ACTROS 4441K 2015-2019 OM-501LA 11,9 LTS



AP84457
AIRE PRIMARIO

D. Exterior	266 mm
D. Interior	168 mm
Altura	490 mm



AP84457SY
AIRE SECUNDARIO

D. Exterior	155 mm
D. Interior	137 mm
Altura	509 mm



AS46018SP
SEPARADOR AGUA
COMBUSTIBLE

D. Exterior	107.8 mm
Rosca	1x14 in
Altura	216 mm



MERCEDES BENZ ACTROS 4140K 2009-2015 OM-541LA, 11.9 LTS



AP84457
AIRE PRIMARIO

D. Exterior	266 mm
D. Interior	168 mm
Altura	490 mm



AP84457SY
AIRE SECUNDARIO

D. Exterior	155 mm
D. Interior	137 mm
Altura	509 mm



AS46018SP
SEPARADOR AGUA
COMBUSTIBLE

D. Exterior	107.8 mm
Rosca	1x14 in
Altura	216 mm

HD / PESADO

ICONOS



Aire



Aceite



Combustible



Separador Agua
Combustible



Aire Cabina



Hidráulico



Refrigerante



Transmisión



Secador de Aire



MERCEDES BENZ ACTROS 3853 AS 2012 OM-502LA, 15.9 Lts, 520Hp

AP84457 AIRE PRIMARIO	AP84457SY AIRE SECUNDARIO	AS46018SP SEPARADOR AGUA COMBUSTIBLE	AA5374 SECADOR DE AIRE
D. Exterior 266 mm D. Interior 168 mm Altura 490 mm	D. Exterior 155 mm D. Interior 137 mm Altura 509 mm	D. Exterior 107.8 mm Rosca 1x14 in Altura 216 mm	D. Exterior 135 mm Rosca M39x1.5 Altura 164 mm



MERCEDES BENZ AXOR 2833K 2015-2018 OM-926LA, 7.2 Lts, 326 Hp 19 Ton

AP25653 AIRE PRIMARIO	PP9452 ACEITE	PP7735 COMBUSTIBLE	AS46018SP SEPARADOR AGUA COMBUSTIBLE
D. Exterior 274 mm D. Interior 127 mm Altura 339 mm	D. Exterior 80 mm D. Interior 39.6 mm Altura 213.4 mm	D. Exterior 91.7 mm D. Interior 27.6 mm Altura 100.5 mm	D. Exterior 107.8 mm Rosca 1x14 in Altura 216 mm



MERCEDES BENZ ATEGO 1016 2016> OM904LA

AP25653 AIRE PRIMARIO	PP7199 ACEITE	PP7735 COMBUSTIBLE	ASV1060SP SEPARADOR AGUA COMBUSTIBLE
D. Exterior 274 mm D. Interior 127 mm Altura 339 mm	D. Exterior 83.4 mm D. Interior 39.7 mm Altura 150.4 mm	D. Exterior 91.7 mm D. Interior 27.6 mm Altura 100.5 mm	D. Exterior 107.8 mm Rosca 1x12 in Altura 245 mm

HD / PESADO

ICONOS



MERCEDES BENZ ATEGO 1017 (970-975) 2012> OM904LA



	AP25653 AIRE PRIMARIO
D. Exterior	274 mm
D. Interior	127 mm
Altura	339 mm



	PP7199 ACEITE
D. Exterior	83.4 mm
D. Interior	39.7 mm
Altura	150.4 mm



	PP7735 COMBUSTIBLE
D. Exterior	91.7 mm
D. Interior	27.6 mm
Altura	100.5 mm



	ASV1060SP SEPARADOR AGUA COMBUSTIBLE
D. Exterior	107.8 mm
Rosca	1x12 in
Altura	245 mm



MERCEDES BENZ ATEGO 1726 EURO V 2017> OM-926 LA EURO V



	AP25653 AIRE PRIMARIO
D. Exterior	274 mm
D. Interior	127 mm
Altura	339 mm



	PP9452 ACEITE
D. Exterior	80 mm
D. Interior	39.6 mm
Altura	213.4 mm



	PP7735 COMBUSTIBLE
D. Exterior	91.7 mm
D. Interior	27.6 mm
Altura	100.5 mm



	PP79915SP SEPARADOR AGUA COMBUSTIBLE
D. Exterior	94 mm
D. Interior	44 mm
Altura	198 mm



MERCEDES BENZ ATEGO 2730 EURO V 2017> OM-926 LA



	AP25653 AIRE PRIMARIO
D. Exterior	274 mm
D. Interior	127 mm
Altura	339 mm



	PP9452 ACEITE
D. Exterior	80 mm
D. Interior	39.6 mm
Altura	213.4 mm



	PP7735 COMBUSTIBLE
D. Exterior	91.7 mm
D. Interior	27.6 mm
Altura	100.5 mm



	PP79915SP SEPARADOR AGUA COMBUSTIBLE
D. Exterior	94 mm
D. Interior	44 mm
Altura	198 mm

HD / PESADO

ICONOS



MERCEDES BENZ O500M / O500U 2004> OM-906LA

AP5627 AIRE PRIMARIO	AP5628 AIRE SECUNDARIO	PP9452 ACEITE	PP7735 COMBUSTIBLE	AA5374 SECADOR DE AIRE
D. Exterior 260 mm D. Interior 146 mm Altura 408 mm	D. Exterior 144 mm D. Interior 111 mm Altura 419 mm	D. Exterior 80 mm D. Interior 39.6 mm Altura 213.4 mm	D. Exterior 91.7 mm D. Interior 27.6 mm Altura 100.5 mm	D. Exterior 135 mm Rosca M39x1.5 Altura 164 mm



NISSAN UD 2000, UD2600 2003-> FE6/TA

AP5021 AIRE PRIMARIO	AP51250 AIRE SECUNDARIO	A1403SP ACEITE	A23SP COMBUSTIBLE	AW2010SP REFRIGERANTE
D. Exterior 277 mm D. Interior 171 mm Altura 394 mm	D. Exterior 162 mm D. Interior 133.4 mm Altura 361.5 mm	D. Exterior 118.3 mm Rosca M36x1.5 Altura 220 mm	D. Exterior 93.7 mm Rosca 1x14 in Altura 166 mm	D. Exterior 93.7 mm Rosca 11/16x16 in Altura 129 mm



RENAULT 3000P MIDLINER MOTOR MACK

AP2677 AIRE PRIMARIO	A67SP ACEITE	A30SP COMBUSTIBLE	AS11001SP SEPARADOR AGUA COMBUSTIBLE	AW475SP REFRIGERANTE
D. Exterior 220 mm D. Interior 132 mm Altura 395 mm	D. Exterior 107.8 mm Rosca 1-1/8x16 in Altura 249 mm	D. Exterior 107.8 mm Rosca 7/8x16 in Altura 185 mm	D. Exterior 107.8 mm Rosca 1x14 in Altura 161 mm	D. Exterior 93.7 mm Rosca 3/4x20 in Altura 129 mm

MERCEDES BENZ

KITS DE APLICACIÓN

NISSAN

RENAULT

HD / PESADO

ICONOS



Aire

Aceite

Combustible

Separador Agua Combustible

Aire Cabina

Hidráulico

Refrigerante

Transmisión

Secador de Aire



RENAULT PREMIUM 260 MIDR 06,02,45



AP2677
AIRE PRIMARIO

D. Exterior 220 mm
D. Interior 132 mm
Altura 395 mm

A67SP
ACEITE

D. Exterior 107,8 mm
Rosca 1-1/8x16 in
Altura 249 mm

A33358
COMBUSTIBLE

D. Exterior 74.2 mm
Rosca M16x1.5 mm
Altura 126 mm

A243004DSP
SEPARADOR AGUA COMBUSTIBLE

D. Exterior 81.3 mm
Rosca M16x1.5 mm
Altura 150 mm



SHACMAN X3000 8X4 CUATRO MANOS 2021 CUMMINS ISM 440 EURO V



AP5538
AIRE PRIMARIO

D. Exterior 280 mm
D. Interior 190 mm
Altura 449 mm

AP5538SY
AIRE SECUNDARIO

D. Exterior 186 mm
D. Interior 168 mm
Altura 392 mm

A9080SP
ACEITE

D. Exterior 118.3 mm
Rosca M95x2.5
Altura 302 mm

AS1003SP
SEPARADOR AGUA COMBUSTIBLE

D. Exterior 93.7 mm
Rosca 1x14 in
Altura 258 mm

AS88583SP
SEPARADOR AGUA COMBUSTIBLE

D. Exterior 107,8 mm
Rosca 1"x14
Altura 228 mm



SHACMAN X3000 4000 MINI MULA 2021 CUMMINS ISM 385 EURO V



A9080SP
ACEITE

D. Exterior 118.3 mm
Rosca M95x2.5
Altura 302 mm

AS1003SP
SEPARADOR AGUA COMBUSTIBLE

D. Exterior 93.7 mm
Rosca 1x14 in
Altura 258 mm

AS88583SP
SEPARADOR AGUA COMBUSTIBLE

D. Exterior 107,8 mm
Rosca 1"x14
Altura 228 mm

RENAULT

KITS DE APLICACIÓN

SHACMAN

HD / PESADO

ICONOS



Aire



Aceite



Combustible



Separador Agua Combustible



Aire Cabina



Hidráulico



Refrigerante



Transmisión



Secador de Aire



SITRAK C7H TRACTO CAMION 2020 MANN MT13 43 50 EURO V GAS NATURAL



AP4971
AIRE PRIMARIO

D. Exterior	266 mm
D. Interior	162 mm
Altura	503 mm

AP4971SY
AIRE SECUNDARIO

D. Exterior	154 mm
D. Interior	132 mm
Altura	454,4 mm



VOLKSWAGEN CONSTELLATION 13-190 / 15-190 /17-190 2012> CUMMINS 6BTA 5.9



PP7196
ACEITE

D. Exterior	83 mm
D. Interior	35 mm
Altura	170 mm

AS27177JSP
SEPARADOR AGUA COMBUSTIBLE

D. Exterior	118.3 mm
Rosca	1x14 in
Altura	219 mm

AW5137SP
REFRIGERANTE

D. Exterior	93.7 mm
Rosca	11/16x16 in
Altura	103 mm



VOLKSWAGEN 15-190 CONSTELLATION 2017> MANN D08 34 4.6 LTS



PP7196
ACEITE

D. Exterior	83 mm
D. Interior	35 mm
Altura	170 mm

AS27177JSP
SEPARADOR AGUA COMBUSTIBLE

D. Exterior	118.3 mm
Rosca	1x14 in
Altura	219 mm

SITRAK

KITS DE APLICACIÓN

VOLKSWAGEN

HD / PESADO

ICONOS



VOLKSWAGEN 17-280 CONSTELLATION 2013> MANN D08 36 280 4,6 LTS 255 HP

AP5627 AIRE PRIMARIO	AP5628 AIRE SECUNDARIO	PP9452 ACEITE	AS27177JSP SEPARADOR AGUA COMBUSTIBLE	AW5137SP REFRIGERANTE	AA5374 REFRIGERANTE
D. Exterior 260 mm D. Interior 146 mm Altura 408 mm	D. Exterior 144 mm D. Interior 111 mm Altura 419 mm	D. Exterior 80 mm D. Interior 39.6 mm Altura 213.4 mm	D. Exterior 118.3 mm Rosca 1x14 in Altura 219 mm	D. Exterior 93.7 mm Rosca 11/16x16 in Altura 103 mm	D. Exterior 135 mm Rosca M39x1.5 Altura 164 mm



VOLKSWAGEN CONSTELLATION 32-360 2019-2022 CUMM. ISL 8.9 LTS 360 HP

AP5627 AIRE PRIMARIO	AP5628 AIRE SECUNDARIO	A3000SP ACEITE	AA5374 REFRIGERANTE
D. Exterior 260 mm D. Interior 146 mm Altura 408 mm	D. Exterior 144 mm D. Interior 111 mm Altura 419 mm	D. Exterior 118.3 mm Rosca 2-1/4x12 in Altura 219.2 mm	D. Exterior 135 mm Rosca M39x1.5 Altura 164 mm



VOLKSWAGEN SERIE 17- 210 CAMION 2004-2008 MWM 6, 12 ELECT

AP5627 AIRE PRIMARIO	A840SP ACEITE	AS4057SP SEPARADOR AGUA COMBUSTIBLE	A950DSP SEPARADOR AGUA COMBUSTIBLE
D. Exterior 260 mm D. Interior 146 mm Altura 408 mm	D. Exterior 93.7 mm Rosca 1x12 in Altura 205 mm	D. Exterior 93.7 mm Rosca 1x14 in Altura 121 mm	D. Exterior 93.7 mm Rosca 1x14 in Altura 212 mm

HD / PESADO

ICONOS



VOLKSWAGEN SERIE 17- 210 CAMION-BUS OD 2001-2003 CUMM. 6BT 5.9T

AP5627 AIRE PRIMARIO	A349SP ACEITE	A840SP ACEITE	A243004SP COMBUSTIBLE	A43SP SEPARADOR AGUA COMBUSTIBLE
D. Exterior 260 mm D. Interior 146 mm Altura 408 mm	D. Exterior 107.8 mm Rosca 1x12 in Altura 235 mm	D. Exterior 93.7 mm Rosca 1x12 in Altura 205 mm	D. Exterior 81.3 mm Rosca M16x1.5 mm Altura 125 mm	D. Exterior 93.7 mm Rosca 13/16x18 in Altura 156 mm



VOLKSWAGEN WORKER 15-190 2013 MANN D08 34 190 DI

AP17308 AIRE PRIMARIO	APC203252SY AIRE SECUNDARIO	PP7196 ACEITE	AA5374 REFRIGERANTE
D. Exterior 167.1 mm D. Interior 109.8 mm Altura 384.3 mm	D. Exterior 95 mm D. Interior 89.6 mm Altura 374 mm	D. Exterior 83 mm D. Interior 35 mm Altura 170 mm	D. Exterior 135 mm Rosca M39x1.5 Altura 164 mm



VOLKSWAGEN 15-180 2001 MWM 6.10, 6CIL

AP5627 AIRE PRIMARIO	AP5628 AIRE SECUNDARIO	A349SP ACEITE	AS1441SP SEPARADOR AGUA COMBUSTIBLE
D. Exterior 260 mm D. Interior 146 mm Altura 408 mm	D. Exterior 144 mm D. Interior 111 mm Altura 419 mm	D. Exterior 107.8 mm Rosca 1x12 in Altura 235 mm	D. Exterior 107.8 mm Rosca 1x14 in Altura 131 mm

VOLKSWAGEN

KITS DE APLICACIÓN

VOLVO

YUTONG

HD / PESADO

ICONOS



Aire

Aceite

Combustible

Separador Agua Combustible

Aire Cabina

Hidráulico

Refrigerante

Transmisión

Secador de Aire



VOLKSWAGEN 17-210 2004-2007 MWM



AP5627
AIRE PRIMARIO

D. Exterior	260 mm
D. Interior	146 mm
Altura	408 mm

A349SP
ACEITE

D. Exterior	107.8 mm
Rosca	1x12 in
Altura	235 mm

AS1249SP
SEPARADOR AGUA COMBUSTIBLE

D. Exterior	93.7 mm
Rosca	1x14 in
Altura	168 mm



VOLVO FMX 420 2003 CUMM N14 PLUS



AP9961
AIRE PRIMARIO

D. Exterior	331 mm
D. Interior	221 mm
Altura	410 mm

A3000SP
ACEITE

D. Exterior	118.3 mm
Rosca	2-1/4x12 in
Altura	219.2 mm

A1259SP
SEPARADOR AGUA COMBUSTIBLE

D. Exterior	93.7 mm
Rosca	1x14 in
Altura	251 mm



YUTONG ZK 6107HA 2020> CUMM. ISD 270 EURO V



AP12020
AIRE PRIMARIO

D. Exterior	306 mm
D. Interior	198 mm
Altura	472 mm

AP12020SY
AIRE SECUNDARIO

D. Exterior	186 mm
D. Interior	156 mm
Altura	419 mm

A7898SP
ACEITE

D. Exterior	93.7 mm
Rosca	M27x2 mm
Altura	178 mm

A7813SP
COMBUSTIBLE

D. Exterior	93.7 mm
Rosca	M20x1.5
Altura	178 mm

A1259SP
SEPARADOR AGUA COMBUSTIBLE

D. Exterior	93.7 mm
Rosca	1x14 in
Altura	251 mm

AA5374
REFRIGERANTE

D. Exterior	135 mm
Rosca	M39x1.5
Altura	164 mm

HD / PESADO

ICONOS



Aire



Aceite



Combustible



Separador Agua
Combustible



Aire Cabina



Hidráulico



Refrigerante



Transmisión



Secador
de Aire



YUTONG ZK6831HE 2012 CUMM. EQB 210 ELECT



AP2216

AIRE PRIMARIO

D. Exterior	277 mm
D. Interior	171 mm
Altura	515 mm



AP4416

AIRE SECUNDARIO

D. Exterior	162 mm
D. Interior	133.4 mm
Altura	490 mm



A339SP

ACEITE

D. Exterior	93.7 mm
Rosca	1x16 in
Altura	165 mm



A243004DSP

SEPARADOR AGUA
COMBUSTIBLE

D. Exterior	81.3 mm
Rosca	M16x1.5 mm
Altura	150 mm



ES JUSTO

LO QUE NECESITAS

KITS DE APLIACIÓN SEGMENTO MEDIANO

**Vehículos de carga y pasajeros
de 3 a 10 toneladas ó 20 a 32 pasajeros**

**SOLUCIONES EN FILTRACIÓN
PARA TRANSPORTE MEDIANO**

MD / MEDIANO

ICONOS



Aire

Aceite

Combustible

Separador Agua Combustible

Aire Cabina

Hidráulico

Refrigerante

Transmisión

Secador de Aire



AGRALE CHASIS MA 8.7 MA9.6 2014-2021 CUMMINS ISF 3.8 LTS 160 HP



APC2050
AIRE PRIMARIO

D. Exterior	196 mm
D. Interior	115 mm
Altura	402 mm

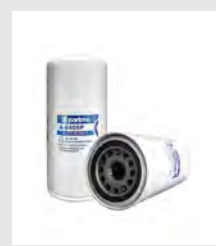

A840SP
ACEITE

D. Exterior	93.7 mm
Rosca	1x12 in
Altura	205 mm



A1259SP
SEPARADOR AGUA COMBUSTIBLE

D. Exterior	93.7 mm
Rosca	1x14 in
Altura	251 mm



AGRALE CHASIS MA 11 2017-2021 CUMMINS ISB 6.7 LTS 226 HP



APC23610
AIRE PRIMARIO

D. Exterior	220 mm
D. Interior	125 mm
Altura	402 mm



PC23610SY
AIRE SECUNDARIO

D. Exterior	114 mm
D. Interior	100 mm
Altura	389 mm



A339SP
ACEITE

D. Exterior	93.7 mm
Rosca	1x16 in
Altura	165 mm



A1212SP
SEPARADOR AGUA COMBUSTIBLE

D. Exterior	93.7 mm
Rosca	1x14 in
Altura	192 mm



AGRALE CHASIS MA 9.0 2017-2021 MWM 4.12 TCE 4.8 LTS 177 HP



APC23610
AIRE PRIMARIO

D. Exterior	220 mm
D. Interior	125 mm
Altura	402 mm



PC23610SY
AIRE SECUNDARIO

D. Exterior	114 mm
D. Interior	100 mm
Altura	389 mm

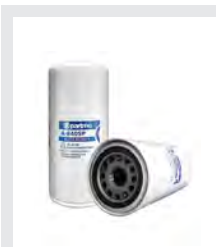

A840SP
ACEITE

D. Exterior	93.7 mm
Rosca	1x12 in
Altura	205 mm



A96SP
COMBUSTIBLE

D. Exterior	93.7 mm
Rosca	1x12 in
Altura	209 mm



A1212SP
SEPARADOR AGUA COMBUSTIBLE

D. Exterior	93.7 mm
Rosca	1x14 in
Altura	192 mm

MD / MEDIANO

ICONOS



Aire



Aceite



Combustible



Separador Agua Combustible



Aire Cabina



Hidráulico



Refrigerante



Transmisión



Secador de Aire



AGRALE MA6.0; MA7.0; MA 8.5: MA9.0 2000-2011 MWM 4.10 TCA 4.3 LTS



APC203252
AIRE PRIMARIO

D. Exterior	197 mm
D. Interior	171 mm
Altura	394 mm



APC203252SY
AIRE SECUNDARIO

D. Exterior	95 mm
D. Interior	16.6 mm
Altura	374 mm



A48SP
ACEITE

D. Exterior	93.7 mm
Rosca	1x12 in
Altura	205 mm

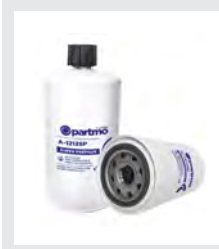

A1212SP
SEPARADOR AGUA COMBUSTIBLE

D. Exterior	93.7 mm
Rosca	1x14 in
Altura	192 mm



AS1441SP
SEPARADOR AGUA COMBUSTIBLE

D. Exterior	107 mm
Rosca	3-3/4x10 in
Altura	131 mm



CHEVROLET NHR / NKR >2.5 TON DIESEL 2001> MOTOR ISUZU

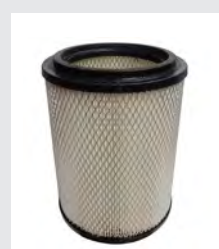

AP2712
AIRE PRIMARIO

D. Exterior	201 mm
D. Interior	130 mm
Altura	265 mm



A4271SP
ACEITE

D. Exterior	93.7 mm
Rosca	M26x1.5
Altura	130 mm



A4053SP
COMBUSTIBLE

D. Exterior	81.3 mm
Rosca	3/4x16 in
Altura	90 mm



CHEVROLET NHR REWARD 2012> ISUZU 2.8L 4JB1-TC / 4JH1-TC



AP2877S
AIRE PRIMARIO

D. Exterior	232 mm
D. Interior	132 mm
Altura	287 mm



A4271SP
ACEITE

D. Exterior	93.7 mm
Rosca	M26x1.5
Altura	130 mm

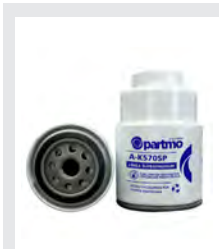

AK570SP
COMBUSTIBLE

D. Exterior	93.7 mm
Rosca	M20x1.5
Altura	139 mm

AGRALE

KITS DE APLICACIÓN

CHEVROLET

MD / MEDIANO

ICONOS



Aire



Aceite



Combustible



Separador Agua Combustible



Aire Cabina



Hidráulico



Refrigerante



Transmisión



Secador de Aire



CHEVROLET NHR REWARD EURO 4 CARGA 2016-2022 4JH1-TC



AP2877S
AIRE PRIMARIO

D. Exterior	232 mm
D. Interior	132 mm
Altura	287 mm

A4271SP
ACEITE

D. Exterior	93.7 mm
Rosca	M26x1.5
Altura	130 mm

PP7355 (2)
COMBUSTIBLE

D. Exterior	84 mm
D. Interior	9 mm
Altura	75.3 mm



CHEVROLET NKR CAMION, TURBO MICROBUS 2000-2010 ISUZU 2.8LT



AP2712
AIRE PRIMARIO

D. Exterior	201 mm
D. Interior	130 mm
Altura	265 mm

A4271SP
ACEITE

D. Exterior	93.7 mm
Rosca	M26x1.5
Altura	130 mm

AK570SP
COMBUSTIBLE

D. Exterior	93.7 mm
Rosca	M20x1.5
Altura	139 mm



CHEVROLET NKR REDWARD 2013 ISUZU 2.8 LITROS



AP2877S
AIRE PRIMARIO

D. Exterior	232 mm
D. Interior	132 mm
Altura	287 mm

PP88580
ACEITE

D. Exterior	65.3 mm
D. Interior	17 mm
Altura	159 mm

AK570SP
COMBUSTIBLE

D. Exterior	93.7 mm
Rosca	M20x1.5
Altura	139 mm

MD / MEDIANO

ICONOS



CHEVROLET NRR REWARD 2022 ISUZU 4HK1-TCS 5.2 LTS EURO IV

AP21413 AIRE PRIMARIO	A2700SP ACEITE	PP28970 COMBUSTIBLE	ASR90TSP SEPARADOR AGUA COMBUSTIBLE
D. Exterior 208 mm D. Interior 107 mm Altura 262 mm	D. Exterior 118 mm Rosca 1-1/2x12 in Altura 125 mm	D. Exterior 89.4 mm D. Interior 12 mm Altura 114 mm	D. Exterior 107 mm Rosca 1x14 in Altura 158 mm



CHEVROLET NLR REWARD 2022 4JJ1-TCC 3.0 EURO IV

AP21413 AIRE PRIMARIO	A4271SP ACEITE	PP7355 (2) COMBUSTIBLE
D. Exterior 208 mm D. Interior 107 mm Altura 262 mm	D. Exterior 93.7 mm Rosca M26x1.5 Altura 130 mm	D. Exterior 84 mm D. Interior 9 mm Altura 75.3 mm



CHEVROLET NNR - NKR REWARD SERIE II Y III ELO 2011-2015 ISUZU 4JJ1-TCN

AP2877S AIRE PRIMARIO	PP88580 ACEITE	PP28970 COMBUSTIBLE	ASR90TSP SEPARADOR AGUA COMBUSTIBLE
D. Exterior 232 mm D. Interior 132 mm Altura 287 mm	D. Exterior 65.3 mm D. Interior 17 mm Altura 159 mm	D. Exterior 89.4 mm D. Interior 12 mm Altura 114 mm	D. Exterior 107 mm Rosca 1x14 in Altura 158 mm

MD / MEDIANO

ICONOS



CHEVROLET

KITS DE APLICACIÓN



CHEVROLET NPR / NQR 4,6 TON 2000-2010 ISUZU 4HK1-TCN / ISUZU-6HK1

AP2877S AIRE PRIMARIO	A2700SP ACEITE	A7041SP ACEITE	A4053SP (2) COMBUSTIBLE	A4054SP COMBUSTIBLE
D. Exterior 232 mm D. Interior 132 mm Altura 287 mm	D. Exterior 118 mm Rosca 1-1/2x12 in Altura 125 mm	D. Exterior 118 mm Rosca 1-1/2x12 in Altura 155 mm	D. Exterior 81.3 mm Rosca 3/4x16 in Altura 90 mm	D. Exterior 81.3 mm Rosca 3/4x16 in Altura 76 mm



CHEVROLET NPR / NQR REWARD EURO IV 148 HP 2011-2021 ISUZU 4HK1-TCN

AP2877S AIRE PRIMARIO	A2700SP ACEITE	A7041SP ACEITE	PP28970 COMBUSTIBLE	ASR90TSP SEPARADOR AGUA COMBUSTIBLE
D. Exterior 232 mm D. Interior 132 mm Altura 287 mm	D. Exterior 118 mm Rosca 1-1/2x12 in Altura 125 mm	D. Exterior 118 mm Rosca 1-1/2x12 in Altura 155 mm	D. Exterior 89.4 mm D. Interior 12 mm Altura 114 mm	D. Exterior 107 mm Rosca 1x14 in Altura 158 mm



CHEVROLET NPR CAMION 1998-2000 ISZ 4BDT2TC 5,9 Lt

AP2712 AIRE PRIMARIO	A4051SP ACEITE	A4052SP ACEITE	A4053SP (2) COMBUSTIBLE	A4054SP COMBUSTIBLE
D. Exterior 201 mm D. Interior 130 mm Altura 265 mm	D. Exterior 81.3 mm Rosca M22x1.5 Altura 103 mm	D. Exterior 107 mm Rosca M20x1.5 Altura 82 mm	D. Exterior 81.3 mm Rosca 3/4x16 in Altura 90 mm	D. Exterior 81.3 mm Rosca 3/4x16 in Altura 76 mm

MD / MEDIANO

ICONOS



CHEVROLET NQR -NQR REWARD 2022 4HK1 TCN 5.2 LTS EURO IV 2WD

AP21413 AIRE PRIMARIO	A2700SP ACEITE	PP7355 COMBUSTIBLE	AK570SP COMBUSTIBLE	ASR90TSP SEPARADOR AGUA COMBUSTIBLE
D. Exterior 208 mm D. Interior 107 mm Altura 262 mm	D. Exterior 118 mm Rosca 1-1/2x12 in Altura 125 mm	D. Exterior 84 mm D. Interior 9 mm Altura 75.3 mm	D. Exterior 93.7 mm Rosca M20x1.5 Altura 139 mm	D. Exterior 107 mm Rosca 1x14 in Altura 158 mm



CHEVROLET NPS REWARD 4X4 2020 4HK1 TCN 5.2 LTS EURO IV 4WD

AP21413 AIRE PRIMARIO	A2700SP ACEITE	PP28970 COMBUSTIBLE	AK570SP COMBUSTIBLE
D. Exterior 208 mm D. Interior 107 mm Altura 262 mm	D. Exterior 118 mm Rosca 1-1/2x12 in Altura 125 mm	D. Exterior 89.4 mm D. Interior 12 mm Altura 114 mm	D. Exterior 93.7 mm Rosca M20x1.5 Altura 139 mm



FORD CARGO 815 LARGO Y CORTO 2001-2008 CUMM 4BT 3.9LT

AP17308 AIRE PRIMARIO	APC203252SY AIRE SECUNDARIO	A427SP ACEITE	A243004SP COMBUSTIBLE	ASV1282SP SEPARADOR AGUA COMBUSTIBLE
D. Exterior 167 mm D. Interior 109 mm Altura 384.3 mm	D. Exterior 95 mm D. Interior 89 mm Altura 374 mm	D. Exterior 93.7 mm Rosca 1x16 in Altura 129 mm	D. Exterior 81.3 mm Rosca M16x1.5 mm Altura 125 mm	D. Exterior 93.7 mm Rosca 1x14 in Altura 185 mm

MD / MEDIANO

ICONOS



Aire



Aceite



Combustible



Separador Agua Combustible



Aire Cabina



Hidráulico



Refrigerante



Transmisión



Secador de Aire



FORD CARGO 816 2019 CUMM. ISB 4,5 EURO V



AP17308

AIRE PRIMARIO

D. Exterior 167 mm
D. Interior 109 mm



A7898SP

ACEITE

D. Exterior 93.7 mm
Rosca M27x2 mm



A7813SP

COMBUSTIBLE

D. Exterior 93.7 mm
Rosca M20x1.5



AS1249SP

SEPARADOR AGUA COMBUSTIBLE

D. Exterior 93.7 mm
Rosca 1x14 in



FOTON AUMARK BJ 1039 2015-2020 2.8 LTS DIESEL EURO IV



AP2206

AIRE PRIMARIO

D. Exterior 198 mm
D. Interior 109 mm
Altura 293 mm



A2863SP

ACEITE

D. Exterior 93.7 mm
Rosca M20x1.5
Altura 111 mm



A1212SP

SEPARADOR AGUA COMBUSTIBLE

D. Exterior 93.7 mm
Rosca 1x14 in
Altura 192 mm



AS36209SP

SEPARADOR AGUA COMBUSTIBLE

D. Exterior 93.7 mm
Rosca M20x1.5
Altura 203 mm



FOTON AUMARK BJ 1045 2019-2021 2.8 LTS DIESEL EURO IV



AP93019

AIRE PRIMARIO

D. Exterior 192 mm
D. Interior 112 mm
Altura 302 mm



PP17356

ACEITE

D. Exterior 101 mm
Rosca M67x4 mm
Altura 156 mm



A1212SP

SEPARADOR AGUA COMBUSTIBLE

D. Exterior 93.7 mm
Rosca 1x14 in
Altura 192 mm



AS36209SP

SEPARADOR AGUA COMBUSTIBLE

D. Exterior 93.7 mm
Rosca M20x1.5
Altura 203 mm

MD / MEDIANO

ICONOS



Aire



Aceite



Combustible



Separador Agua Combustible



Aire Cabina



Hidráulico



Refrigerante



Transmisión



Secador de Aire



FOTON AUMARK BJ 1039 2016-2020 2.8 LTS DIESEL EURO IV



AP2206

AIRE PRIMARIO

D. Exterior	198 mm
D. Interior	109 mm
Altura	293 mm



PP17356

ACEITE

D. Exterior	101 mm
Rosca	M67x4 mm
Altura	156 mm



A1212SP

SEPARADOR AGUA COMBUSTIBLE

D. Exterior	93.7 mm
Rosca	1x14 in
Altura	192 mm



AS36209SP

SEPARADOR AGUA COMBUSTIBLE

D. Exterior	93.7 mm
Rosca	M20x1.5
Altura	203 mm



FOTON AUMARK BJ 1065 2016> CUMMINS 2,8 EURO IV



AP93019

AIRE PRIMARIO

D. Exterior	192 mm
D. Interior	112 mm
Altura	302 mm



PP17356

ACEITE

D. Exterior	101 mm
Rosca	M67x4 mm
Altura	156 mm



A1212SP

SEPARADOR AGUA COMBUSTIBLE

D. Exterior	93.7 mm
Rosca	1x14 in
Altura	192 mm



AS36209SP

SEPARADOR AGUA COMBUSTIBLE

D. Exterior	93.7 mm
Rosca	M20x1.5
Altura	203 mm



FOTON AUMARK BJ 1065 3,5 TON 2018> CUMMINS 2,8 LTS EURO IV



AP93019

AIRE PRIMARIO

D. Exterior	192 mm
D. Interior	112 mm
Altura	302 mm



A7898SP

ACEITE

D. Exterior	93.7 mm
Rosca	M27x2 mm
Altura	178 mm



PP5706

SEPARADOR AGUA COMBUSTIBLE

D. Exterior	100 mm
Rosca	M100 x4 7H mm
Altura	213 mm



A7301DSP

SEPARADOR AGUA COMBUSTIBLE

D. Exterior	107 mm
Rosca	1x14 in
Altura	193 mm

FOTON

KITS DE APLICACIÓN

MD / MEDIANO

ICONOS



Aire

Aceite

Combustible

Separador Agua Combustible

Aire Cabina

Hidráulico

Refrigerante

Transmisión

Secador de Aire



FOTON AUMARK BJ 1078 2018> CUMMINS ISF 3,8 EURO IV

AP93019 AIRE PRIMARIO	PP17356 ACEITE	A1212SP SEPARADOR AGUA COMBUSTIBLE	AS36209SP SEPARADOR AGUA COMBUSTIBLE
D. Exterior 192 mm D. Interior 112 mm Altura 302 mm	D. Exterior 101 mm Rosca M67x4 mm Altura 156 mm	D. Exterior 93.7 mm Rosca 1x14 in Altura 192 mm	D. Exterior 93.7 mm Rosca M20x1.5 Altura 203 mm



FOTON AUMARK BJ 1126 2020 CUMMINS ISF 4.5 LTS EURO V

AP1126 AIRE PRIMARIO	AP1126SY AIRE SECUNDARIO	A7898SP ACEITE	PP5706 SEPARADOR AGUA COMBUSTIBLE	ASR90TDSP SEPARADOR AGUA COMBUSTIBLE	AA5374 SEPARADOR AGUA COMBUSTIBLE
D. Exterior 223 mm D. Interior 183 mm Altura 382 mm	D. Exterior 181 mm D. Interior 96 mm Altura 363 mm	D. Exterior 93.7 mm Rosca M27x2 mm Altura 178 mm	D. Exterior 100 mm Rosca M100 x4 7H mm Altura 213 mm	D. Exterior 107 mm Rosca M12x1.5 mm Altura 194 mm	D. Exterior 135 mm Rosca M39x1.5 Altura 164 mm



FOTON FHR 2.9 TON XL BJ1044 FOTON 4J28TC 2.8 LTS EURO IV

AP2231 AIRE PRIMARIO	A2863SP ACEITE	A1212SP SEPARADOR AGUA COMBUSTIBLE	AS36209SP SEPARADOR AGUA COMBUSTIBLE
D. Exterior 163 mm D. Interior 87 mm Altura 269 mm	D. Exterior 93.7 mm Rosca M20x1.5mm Altura 111 mm	D. Exterior 93.7 mm Rosca 1x14 in Altura 192 mm	D. Exterior 93.7 mm Rosca M20x1.5 Altura 203 mm

MD / MEDIANO

ICONOS



Aire



Aceite



Combustible



Separador Agua Combustible



Aire Cabina



Hidráulico



Refrigerante



Transmisión



Secador de Aire



FOTON AUMARK FHR 2.8 TON BJ1039 2020 FOTON 4J28TC 2.8 LTS EURO IV



AP2299

AIRE PRIMARIO

D. Exterior	198 mm
D. Interior	114 mm
Altura	344 mm



A2863SP

ACEITE

D. Exterior	93.7 mm
Rosca	M20x1.5mm
Altura	111 mm



AS36209SP

SEPARADOR AGUA COMBUSTIBLE

D. Exterior	93.7 mm
Rosca	M20x1.5
Altura	203 mm



FOTON FHR 3.0 TON 2020 CUMMINS ISF 3,8 LTS EURO IV



AP93019

AIRE PRIMARIO

D. Exterior	192 mm
D. Interior	112 mm
Altura	302 mm



PP17356

ACEITE

D. Exterior	101 mm
Rosca	M67x4 mm
Altura	156 mm



AS36209SP

SEPARADOR AGUA COMBUSTIBLE

D. Exterior	93.7 mm
Rosca	M20x1.5
Altura	203 mm



FOTON FQR BJ1108 2021 CUMMINS ISF 3,8 154 HP EURO IV



AP93019

AIRE PRIMARIO

D. Exterior	192 mm
D. Interior	112 mm
Altura	302 mm



A7898SP

ACEITE

D. Exterior	93.7 mm
Rosca	M27x2 mm
Altura	178 mm



PP5706

SEPARADOR AGUA COMBUSTIBLE

D. Exterior	100 mm
Rosca	M100 x4 7H mm
Altura	213 mm



ASR90TDSP

SEPARADOR AGUA COMBUSTIBLE

D. Exterior	107 mm
Rosca	M12x1.5 mm
Altura	194 mm

MD / MEDIANO

ICONOS



Aire



Aceite



Combustible



Separador Agua Combustible



Aire Cabina



Hidráulico



Refrigerante



Transmisión



Secador de Aire



FOTON FPR BJ1078 2021 CUMMINS ISF 3,8 EURO IV



AP93019
AIRE PRIMARIO
D. Exterior 192 mm
D. Interior 112 mm
Altura 302 mm

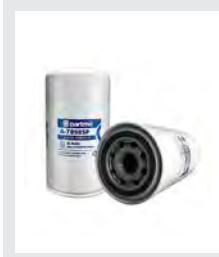

A7898SP
ACEITE
D. Exterior 93.7 mm
Rosca M27x2 mm
Altura 178 mm

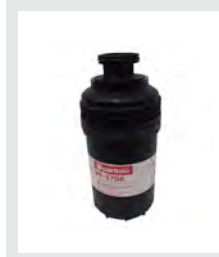

PP5706
SEPARADOR AGUA COMBUSTIBLE
D. Exterior 100 mm
Rosca M100 x4 7H mm
Altura 213 mm



ASR90TDSP
SEPARADOR AGUA COMBUSTIBLE
D. Exterior 107 mm
Rosca M12x1.5 mm
Altura 194 mm



FOTON FRR-S BJ1128 2021 CUMMINS ISF 3.8 LTS

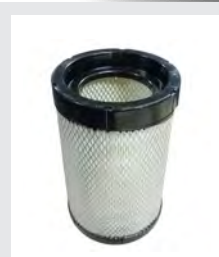

AP93019
AIRE PRIMARIO
D. Exterior 192 mm
D. Interior 112 mm
Altura 302 mm

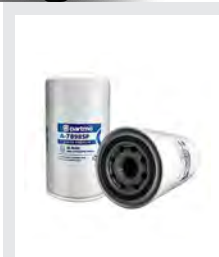

A7898SP
ACEITE
D. Exterior 93.7 mm
Rosca M27x2 mm
Altura 178 mm

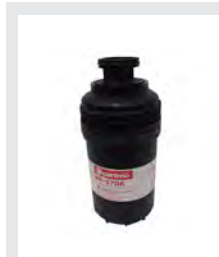

PP5706
SEPARADOR AGUA COMBUSTIBLE
D. Exterior 100 mm
Rosca M100 x4 7H mm
Altura 213 mm



ASR90TDSP
SEPARADOR AGUA COMBUSTIBLE
D. Exterior 107 mm
Rosca M12x1.5 mm
Altura 194 mm



FOTON FKR 2021 CUMMINS ISF 2,8 EURO IV

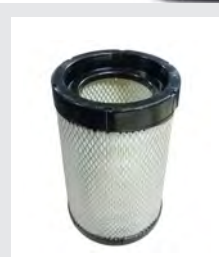

AP93019
AIRE PRIMARIO
D. Exterior 192 mm
D. Interior 112 mm
Altura 302 mm



PP17356
ACEITE
D. Exterior 101 mm
Rosca M67x4 mm
Altura 156 mm

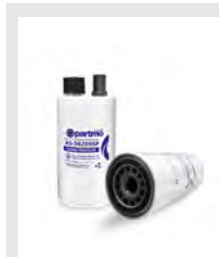

AS36209SP
SEPARADOR AGUA COMBUSTIBLE
D. Exterior 93.7 mm
Rosca M20x1.5 mm
Altura 203 mm

MD / MEDIANO

ICONOS



Aire



Aceite



Combustible



Separador Agua Combustible



Aire Cabina



Hidráulico



Refrigerante



Transmisión



Secador de Aire

FOTON

KITS DE APLICACIÓN



FOTON FKX 2021 FOTON 4J28TC 2.8 LTS EURO IV

AP93019 AIRE PRIMARIO	A2863SP ACEITE	AR16SP SEPARADOR AGUA COMBUSTIBLE	ASR90TDSP SEPARADOR AGUA COMBUSTIBLE
D. Exterior 192 mm D. Interior 112 mm Altura 302 mm	D. Exterior 93.7 mm Rosca M20x1.5mm Altura 111 mm	D. Exterior 93.7 mm Rosca 1x14 in Altura 156 mm	D. Exterior 107 mm Rosca M12x1.5 mm Altura 194 mm



FOTON AUMARK BJ1129 2018-2021 CUMMINS ISF 3,8 EURO IV

AP2251 AIRE PRIMARIO	A7898SP ACEITE	PP5706 SEPARADOR AGUA COMBUSTIBLE	ASR90TDSP SEPARADOR AGUA COMBUSTIBLE
D. Exterior 220 mm D. Interior 134 mm Altura 320.5 mm	D. Exterior 93.7 mm Rosca M27x2 mm Altura 178 mm	D. Exterior 100 mm Rosca M100 x4 7H mm Altura 213 mm	D. Exterior 107 mm Rosca M12x1.5 mm Altura 194 mm



FOTON AUMARK BJ1041 2.8 T 2015-2022 CUMM. ISF EURO IV

AP2231 AIRE PRIMARIO	PP17356 ACEITE	A1212SP SEPARADOR AGUA COMBUSTIBLE	AS36209SP SEPARADOR AGUA COMBUSTIBLE
D. Exterior 163 mm D. Interior 87 mm Altura 269 mm	D. Exterior 101 mm Rosca M67x4 mm Altura 156 mm	D. Exterior 93.7 mm Rosca 1x14 in Altura 192 mm	D. Exterior 93.7 mm Rosca M20x1.5 Altura 203 mm

MD / MEDIANO

ICONOS



FOTON AUMARK BJ1049 2.8 T LLANTA SENCILLA 2016> CUMM. ISF EURO IV



AP2231
AIRE PRIMARIO
D. Exterior 163 mm
D. Interior 87 mm
Altura 269 mm



PP17356
ACEITE
D. Exterior 101 mm
Rosca M67x4 mm
Altura 156 mm



A1212SP
SEPARADOR AGUA COMBUSTIBLE
D. Exterior 93.7 mm
Rosca 1x14 in
Altura 192 mm



AS36209SP
SEPARADOR AGUA COMBUSTIBLE
D. Exterior 93.7 mm
Rosca M20x1.5
Altura 203 mm

FOTON

KITS DE APLICACIÓN

FOTON AUMARK BJ1061 6.0 T, 3.8 Lt 2015-2020 CUMM. ISF EURO IV DI



AP2251
AIRE PRIMARIO
D. Exterior 220 mm
D. Interior 134 mm
Altura 320.5 mm



A7898SP
ACEITE
D. Exterior 93.7 mm
Rosca M27x2 mm
Altura 178 mm



PP5706
SEPARADOR AGUA COMBUSTIBLE
D. Exterior 100 mm
Rosca M100 x4 7H mm
Altura 213 mm



ASR90TDSP
SEPARADOR AGUA COMBUSTIBLE
D. Exterior 107 mm
Rosca M12x1.5 mm
Altura 194 mm



FOTON OLIN 5089 5,8 T CAB SENCILLA 154 HP 2010 CUMM. ISF 3,8 LTS



AP2251
AIRE PRIMARIO
D. Exterior 220 mm
D. Interior 134 mm
Altura 320.5 mm



A7898SP
ACEITE
D. Exterior 93.7 mm
Rosca M27x2 mm
Altura 178 mm



PP5706
SEPARADOR AGUA COMBUSTIBLE
D. Exterior 100 mm
Rosca M100 x4 7H mm
Altura 213 mm



ASR90TDSP
SEPARADOR AGUA COMBUSTIBLE
D. Exterior 107 mm
Rosca M12x1.5 mm
Altura 194 mm



AA5374
SEPARADOR AGUA COMBUSTIBLE
D. Exterior 135 mm
Rosca M39x1.5
Altura 164 mm

MD / MEDIANO

ICONOS



Aire

Aceite

Combustible

Separador Agua Combustible

Aire Cabina

Hidráulico

Refrigerante

Transmisión

Secador de Aire

FOTON



FOTON AUMAN BJ5126 2019 CUMMINS ISF 4,5 / 185 HP



	AP1126	AIRE PRIMARIO
D. Exterior	223 mm	
D. Interior	183 mm	
Altura	382 mm	

	AP1126SY	AIRE SECUNDARIO
D. Exterior	181 mm	
D. Interior	96 mm	
Altura	363 mm	

	A7898SP	ACEITE
D. Exterior	93.7 mm	
Rosca	M27x2 mm	
Altura	178 mm	

	PP5706	SEPARADOR AGUA COMBUSTIBLE
D. Exterior	100 mm	
Rosca	M100 x4 7H mm	
Altura	213 mm	

	ASR90TDSP	SEPARADOR AGUA COMBUSTIBLE
D. Exterior	107 mm	
Rosca	M12x1.5 mm	
Altura	194 mm	

KITS DE APLICACIÓN

HINO



HINO CAMION 500 FG1J / GD1J 2005 HINO J08C-TT



	AP1325	AIRE PRIMARIO
D. Exterior	232 mm	
D. Interior	123 mm	
Altura	437 mm	

	AP1330E	AIRE SECUNDARIO
D. Exterior	110 mm	
D. Interior	83 mm	
Altura	411 mm	

	A7105SP	ACEITE
D. Exterior	118 mm	
Rosca	1-1/2x16 in	
Altura	206 mm	

	A034L	COMBUSTIBLE
D. Exterior	81.3 mm	
Rosca	3/4x16 in	
Altura	103 mm	

	AS1441SP	SEPARADOR AGUA COMBUSTIBLE
D. Exterior	107 mm	
Rosca	3-3/4x10 in	
Altura	131 mm	



HINO CAMIÓN DUTRO MAX CITY 300, 4.000cc 2011-2016 616 N04C-TT 148HP



	AP78020	AIRE PRIMARIO
D. Exterior	232 mm	
D. Interior	132 mm	
Altura	262 mm	

	A7144SP	ACEITE
D. Exterior	107 mm	
Rosca	1x12 in	
Altura	143 mm	

	A4048SP	ACEITE
D. Exterior	107 mm	
Rosca	1x12 in	
Altura	143 mm	

	PP1112	SEPARADOR AGUA COMBUSTIBLE
D. Exterior	78.7 mm	
D. Interior	12 mm	
Altura	90.7 mm	

	PM1940	SEPARADOR AGUA COMBUSTIBLE
D. Exterior	94.5 mm	
D. Interior	27 mm	
Altura	99 mm	

MD / MEDIANO

ICONOS



Aire

Aceite

Combustible

Separador Agua Combustible

Aire Cabina

Hidráulico

Refrigerante

Transmisión

Secador de Aire



HINO CAMION FC4J, FC500 2004> J05C- TF



AP17871
AIRE PRIMARIO

D. Exterior 216 mm
D. Interior 123 mm
Altura 342 mm

AP17871SY
AIRE SECUNDARIO

D. Exterior 106 mm
D. Interior 82 mm
Altura 331 mm

A7105SP
ACEITE

D. Exterior 118 mm
Rosca 1-1/2x16 in
Altura 206 mm

A034L
COMBUSTIBLE

D. Exterior 81.3 mm
Rosca 3/4x16 in
Altura 103 mm

AS1441SP
SEPARADOR AGUA COMBUSTIBLE

D. Exterior 107 mm
Rosca 3-3/4x10 in
Altura 131 mm



HINO CAMIÓN FC9J EXPRESS 2013 E-7 350 E-TECH



AP17871
AIRE PRIMARIO

D. Exterior 216 mm
D. Interior 123 mm
Altura 342 mm

AP17871SY
AIRE SECUNDARIO

D. Exterior 106 mm
D. Interior 82 mm
Altura 331 mm

A7105SP
ACEITE

D. Exterior 118 mm
Rosca 1-1/2x16 in
Altura 206 mm

PP11682SP
COMBUSTIBLE

D. Exterior 89 mm
D. Interior 24 mm
Altura 115 mm

PM1940
SEPARADOR AGUA COMBUSTIBLE

D. Exterior 94.5 mm
D. Interior 27 mm
Altura 99 mm



HINO DUTRO 300 MAX EURO IV 6 TON 2013-2018 NO4CVC 4.0 LTS EURO IV-V



AP78090
AIRE PRIMARIO

D. Exterior 232 mm
D. Interior 132 mm
Altura 212 mm

A4048SP
ACEITE

D. Exterior 107 mm
Rosca 1x12 in
Altura 143 mm

PP1112
SEPARADOR AGUA COMBUSTIBLE

D. Exterior 78.7 mm
D. Interior 12 mm
Altura 90.7 mm

PP78091SP
SEPARADOR AGUA COMBUSTIBLE

D. Exterior 78.3 mm
D. Interior 12 mm
Altura 145.4 mm

MD / MEDIANO

ICONOS



Aire

Aceite

Combustible

Separador Agua Combustible

Aire Cabina

Hidráulico

Refrigerante

Transmisión

Secador de Aire



HINO DUTRO 300 CAMION 2008-2010 J05C



AP78020
AIRE PRIMARIO

D. Exterior	223 mm
D. Interior	183 mm
Altura	382 mm

A7144SP
ACEITE

D. Exterior	107 mm
Rosca	1x12 in
Altura	143 mm

A4048SP
ACEITE

D. Exterior	107 mm
Rosca	1x12 in
Altura	143 mm

A034L
SEPARADOR AGUA COMBUSTIBLE

D. Exterior	81.3 mm
Rosca	3/4x16 in
Altura	103 mm

PP7751
SEPARADOR AGUA COMBUSTIBLE

D. Exterior	104 mm
D. Interior	20 mm
Altura	110.3 mm



HINO DUTRO 300 PRO 2,6 TON 2016-2020



AP78090
AIRE PRIMARIO

D. Exterior	232 mm
D. Interior	132 mm
Altura	212 mm

A7144SP
ACEITE

D. Exterior	107 mm
Rosca	1x12 in
Altura	143 mm

A4048SP
ACEITE

D. Exterior	107 mm
Rosca	1x12 in
Altura	143 mm

A4023SP
COMBUSTIBLE

D. Exterior	107 mm
Rosca	1x14 in
Altura	82 mm

PP1112
SEPARADOR AGUA COMBUSTIBLE

D. Exterior	78.7 mm
D. Interior	12 mm
Altura	90.7 mm

PP78091SP
SEPARADOR AGUA COMBUSTIBLE

D. Exterior	78.3 mm
D. Interior	12 mm
Altura	145.4 mm



HINO FC9J BUSETON - CAMION LIGHT 2015> J05E US 177 HP EURO V



AP17871
AIRE PRIMARIO

D. Exterior	216 mm
D. Interior	123 mm
Altura	342 mm

AP17871SY
AIRE SECUNDARIO

D. Exterior	106 mm
D. Interior	82 mm
Altura	331 mm

A7105SP
ACEITE

D. Exterior	118 mm
Rosca	1-1/2x16 in
Altura	206 mm

PPO4041
COMBUSTIBLE

D. Exterior	80 mm
D. Interior	17 mm
Altura	71 mm

PM1940
SEPARADOR AGUA COMBUSTIBLE

D. Exterior	94.5 mm
D. Interior	27 mm
Altura	99 mm

MD / MEDIANO

ICONOS



HINO FM8J 2017> J08E 7.7 LTS EURO IV

AP1325 AIRE PRIMARIO	AP1330E AIRE SECUNDARIO	A7105SP ACEITE	PP11682SP COMBUSTIBLE	PM1730SP SEPARADOR AGUA COMBUSTIBLE
D. Exterior 232 mm D. Interior 123 mm Altura 437 mm	D. Exterior 110 mm D. Interior 83 mm Altura 411 mm	D. Exterior 118 mm Rosca 1-1/2x16 in Altura 206 mm	D. Exterior 89 mm D. Interior 24 mm Altura 115 mm	D. Exterior 94.5 mm D. Interior 27 mm Altura 193 mm



HINO FC9J 2012-2014 J05ETC 5.1 LTS EURO III

AP17871 AIRE PRIMARIO	AP17871SY AIRE SECUNDARIO	A7105SP ACEITE	PP11682SP COMBUSTIBLE	PM1940 SEPARADOR AGUA COMBUSTIBLE
D. Exterior 216 mm D. Interior 123 mm Altura 342 mm	D. Exterior 106 mm D. Interior 82 mm Altura 331 mm	D. Exterior 118 mm Rosca 1-1/2x16 in Altura 206 mm	D. Exterior 89 mm D. Interior 24 mm Altura 115 mm	D. Exterior 94.5 mm D. Interior 27 mm Altura 99 mm



HINO GB 2013-2021 HINO N04C TT

AP78090 AIRE PRIMARIO	A4048SP ACEITE	PP1112 SEPARADOR AGUA COMBUSTIBLE	PP78091SP SEPARADOR AGUA COMBUSTIBLE
D. Exterior 232 mm D. Interior 132 mm Altura 212 mm	D. Exterior 107 mm Rosca 1x12 in Altura 143 mm	D. Exterior 78.7 mm D. Interior 12 mm Altura 90.7 mm	D. Exterior 78.3 mm D. Interior 12 mm Altura 145.4 mm

HINO

KITS DE APLICACIÓN

MD / MEDIANO

ICONOS



Aire

Aceite

Combustible

Separador Agua Combustible

Aire Cabina

Hidráulico

Refrigerante

Transmisión

Secador de Aire



HYUNDAI BUS COUNTY 2012 D4DD / CRDI Euro II 3.3 y 4.0 lts 150HP



AP5A500
AIRE PRIMARIO

D. Exterior 235 mm
D. Interior 129 mm
Altura 303.5 mm

A7028SP
ACEITE

D. Exterior 107 mm
Rosca M26x1.5
Altura 130 mm

AS5850SP
SEPARADOR AGUA COMBUSTIBLE

D. Exterior 107 mm
Rosca 1x14 in
Altura 161 mm



HYUNDAI HD65 2016> D4GA 3,9 LTS EURO IV



AP5A500
AIRE PRIMARIO

D. Exterior 235 mm
D. Interior 129 mm
Altura 303.5 mm

A7028SP
ACEITE

D. Exterior 107 mm
Rosca M26x1.5
Altura 130 mm

AS5850SP
SEPARADOR AGUA COMBUSTIBLE

D. Exterior 107 mm
Rosca 1x14 in
Altura 161 mm



HYUNDAI HD65 3,96 TON CHASIS CABINADO CAMIÓN 2006-2019 D4DBD 3.900cc



AP5H100
AIRE PRIMARIO

D. Exterior 196 mm
D. Interior 132 mm
Altura 292 mm

A7028SP
ACEITE

D. Exterior 107 mm
Rosca M26x1.5
Altura 130 mm

A3726SP
COMBUSTIBLE

D. Exterior 93.7 mm
Rosca M20x1.5 mm
Altura 99 mm

AS5850SP
SEPARADOR AGUA COMBUSTIBLE

D. Exterior 107 mm
Rosca 1x14 in
Altura 161 mm

MD / MEDIANO

ICONOS



Aire



Aceite



Combustible



Separador Agua Combustible



Aire Cabina



Hidráulico



Refrigerante



Transmisión



Secador de Aire



HYUNDAI HD72 CHASIS CABINADO CAMIÓN 2001 TCI D4DB



AP5H100
AIRE PRIMARIO

D. Exterior	196 mm
D. Interior	132 mm
Altura	292 mm



A28SP
ACEITE

D. Exterior	93.7 mm
Rosca	M26x1.5
Altura	120 mm



A3726SP
COMBUSTIBLE

D. Exterior	93.7 mm
Rosca	M20x1.5 mm
Altura	99 mm



HYUNDAI HD78C / HD78BC 2016> D4GA17 4.0 LTS EURO V



AP5A500
AIRE PRIMARIO

D. Exterior	235 mm
D. Interior	129 mm
Altura	303.5 mm



PP52001
ACEITE

D. Exterior	83.4 mm
D. Interior	40 mm
Altura	129 mm



AS5850SP
SEPARADOR AGUA COMBUSTIBLE

D. Exterior	107 mm
Rosca	1x14 in
Altura	161 mm



HYUNDAI HD78 CAMION 4LTS 5.4T 2011-2015 3.3 Y 4.0 Lts, 150HP



AP5A500
AIRE PRIMARIO

D. Exterior	235 mm
D. Interior	129 mm
Altura	303.5 mm



A092SP
ACEITE

D. Exterior	107 mm
Rosca	M26x1.5
Altura	131 mm



AS5850SP
SEPARADOR AGUA COMBUSTIBLE

D. Exterior	107 mm
Rosca	1x14 in
Altura	161 mm

MD / MEDIANO

ICONOS



Aire

Aceite

Combustible

Separador Agua Combustible

Aire Cabina

Hidráulico

Refrigerante

Transmisión

Secador de Aire



JAC 1040 - 1045 2003-2012 DIESEL



AP2224
AIRE PRIMARIO

D. Exterior	224 mm
D. Interior	139 mm
Altura	248 mm

A54SP
ACEITE

D. Exterior	93.7 mm
Rosca	1x12 in
Altura	129 mm

AS103SP
SEPARADOR AGUA COMBUSTIBLE

D. Exterior	74.8 mm
Rosca	M20x1.5
Altura	152 mm

A243004DSP
SEPARADOR AGUA COMBUSTIBLE

D. Exterior	81.3 mm
Rosca	M16x1.5 mm
Altura	150 mm



JAC JPR POWER 1048 MOD. 2018 WEICHA 2.9 LTS EURO IV



AP2877S
AIRE PRIMARIO

D. Exterior	232 mm
D. Interior	132 mm
Altura	287 mm

AP2877SY
AIRE SECUNDARIO

D. Exterior	130 mm
D. Interior	101 mm
Altura	270 mm

A54SP
ACEITE

D. Exterior	93.7 mm
Rosca	1x12 in
Altura	129 mm

A1345SP
SEPARADOR AGUA COMBUSTIBLE

D. Exterior	107 mm
Rosca	1x14 in
Altura	170 mm

AS1441SP
SEPARADOR AGUA COMBUSTIBLE

D. Exterior	107 mm
Rosca	1x14 in
Altura	131 mm



JAC JPR POWER 2018 MAXXFORCE 3.2 LTS NAVISTAR



AP2877S
AIRE PRIMARIO

D. Exterior	232 mm
D. Interior	132 mm
Altura	287 mm

AP2877SY
AIRE SECUNDARIO

D. Exterior	130 mm
D. Interior	101 mm
Altura	270 mm

A54SP
ACEITE

D. Exterior	93.7 mm
Rosca	1x12 in
Altura	129 mm

A7653
COMBUSTIBLE

D. Exterior	93.7 mm
Rosca	M18x1.5 mm
Altura	204 mm

AS1228SP
SEPARADOR AGUA COMBUSTIBLE

D. Exterior	107 mm
Rosca	1x14 in
Altura	164 mm

JAC

KITS DE APLICACIÓN

MD / MEDIANO

ICONOS



Aire

Aceite

Combustible

Separador Agua Combustible

Aire Cabina

Hidráulico

Refrigerante

Transmisión

Secador de Aire



JAC JKR POWER 1040; 1042 MAX 2.8 Lts 2021 JAC HFC4DE1-1C EURO 4



AP85051
AIRE PRIMARIO

D. Exterior	174 mm
D. Interior	98 mm
Altura	258 mm

A52041SP
ACEITE

D. Exterior	76.4 mm
Rosca	M22x1.5
Altura	107 mm

AS36268SP
COMBUSTIBLE

D. Exterior	93.7 mm
Rosca	M20x1.5 mm
Altura	203 mm



JAC JHR POWER 1035 / 1036 2.8 Lts 2020> JAC HFC4DE1-1C EURO 4



AP85051
AIRE PRIMARIO

D. Exterior	174 mm
D. Interior	98 mm
Altura	258 mm

A52041SP
ACEITE

D. Exterior	76.4 mm
Rosca	M22x1.5
Altura	107 mm

AS36268SP

D. Exterior	93.7 mm
Rosca	M20x1.5 mm
Altura	203 mm



JAC JQR POWER 3.8 Lts 2017 CUMMINS ISF 3.8



AP2236
AIRE PRIMARIO

D. Exterior	215 mm
D. Interior	115 mm
Altura	264 mm

A7898SP
ACEITE

D. Exterior	93.7 mm
Rosca	M27x2 mm
Altura	178 mm

PP5706
COMBUSTIBLE

D. Exterior	100 mm
D. Interior	M100x4 7H mm
Altura	213 mm

MD / MEDIANO

ICONOS



Aire



Aceite



Combustible



Separador Agua Combustible



Aire Cabina



Hidráulico



Refrigerante



Transmisión



Secador de Aire

JAC



JAC JRR 1120 POWER 3.8 Lts 2017-2021 CUMMINS ISF 3.8



AP2251

AIRE PRIMARIO

D. Exterior	220 mm
D. Interior	134 mm
Altura	320.5 mm



A7898SP

ACEITE

D. Exterior	93.7 mm
Rosca	M27x2 mm
Altura	178 mm



PP5706

COMBUSTIBLE

D. Exterior	100 mm
D. Interior	M100x4 7H mm
Altura	213 mm



AS1228SP

SEPARADOR AGUA COMBUSTIBLE

D. Exterior	107 mm
Rosca	M16x1.5 mm
Altura	164 mm



JAC 1048 3.4 108HP 2014> WEICHAH 3400 CC EURO II



AP2236

AIRE PRIMARIO

D. Exterior	215 mm
D. Interior	115 mm
Altura	264 mm



A810

ACEITE

D. Exterior	93.7 mm
Rosca	M24x2 mm
Altura	129 mm



A243004SP

SEPARADOR AGUA COMBUSTIBLE

D. Exterior	81.3 mm
Rosca	M16x1.5 mm
Altura	125 mm



AK570SP

SEPARADOR AGUA COMBUSTIBLE

D. Exterior	93.7 mm
Rosca	M20x1.5
Altura	139 mm



JAC CAMION 1061 2011> 4 CILINDROS



AP2236

AIRE PRIMARIO

D. Exterior	215 mm
D. Interior	115 mm
Altura	264 mm



A427SP

ACEITE

D. Exterior	93.7 mm
Rosca	1x16 in
Altura	129 mm



A243004DSP

SEPARADOR AGUA COMBUSTIBLE

D. Exterior	81.3 mm
Rosca	M16x1.5 mm
Altura	150 mm

MD / MEDIANO

ICONOS



JAC CAMIÓN 1083 2013> CUMM. ISF 3.8

AP2877S AIRE PRIMARIO	AP2877SY AIRE SECUNDARIO	A7898SP ACEITE	A7813SP COMBUSTIBLE	PP5706 COMBUSTIBLE	AS1228SP SEPARADOR AGUA COMBUSTIBLE
D. Exterior 232 mm D. Interior 132 mm Altura 287 mm	D. Exterior 130 mm D. Interior 101 mm Altura 270 mm	D. Exterior 93.7 mm Rosca M27x2 mm Altura 178 mm	D. Exterior 93.7 mm Rosca M20x1.5 mm Altura 178 mm	D. Exterior 100 mm D. Interior M100x4 7H mm Altura 213 mm	D. Exterior 107 mm Rosca M16x1.5 mm Altura 164 mm



JAC CHASIS BUSETA 2014 DIESEL

AP2291 AIRE PRIMARIO	AP4091 AIRE SECUNDARIO	A7898SP ACEITE	A7813SP COMBUSTIBLE	ASR90TSP SEPARADOR AGUA COMBUSTIBLE
D. Exterior 241 mm D. Interior 133 mm Altura 493 mm	D. Exterior 125 mm D. Interior 115 mm Altura 473 mm	D. Exterior 93.7 mm Rosca M27x2 mm Altura 178 mm	D. Exterior 93.7 mm Rosca M20x1.5 mm Altura 178 mm	D. Exterior 107 mm Rosca 1x14 in Altura 158 mm



JAC 1035 2012> JAC 4CIL

AP2712 AIRE PRIMARIO	AP2712SY AIRE SECUNDARIO	A2863SP ACEITE	A243004SP (2) COMBUSTIBLE	AK570SP SEPARADOR AGUA COMBUSTIBLE
D. Exterior 201 mm D. Interior 130 mm Altura 265 mm	D. Exterior 122 mm D. Interior 92 mm Altura 211 mm	D. Exterior 93.7 mm Rosca M20x1.5 Altura 111 mm	D. Exterior 81.3 mm Rosca M16x1.5 mm Altura 125 mm	D. Exterior 93.7 mm Rosca M20x1.5 Altura 139 mm

MD / MEDIANO

ICONOS



Aire



Aceite



Combustible



Separador Agua Combustible



Aire Cabina



Hidráulico



Refrigerante



Transmisión



Secador de Aire



JAC 1035 /1040 /1045 2012> CUMM.



AP2253

AIRE PRIMARIO

D. Exterior 178 mm
D. Interior 109 mm
Altura 263.6 mm



A54SP

ACEITE

D. Exterior 93.7 mm
Rosca 1x12 in
Altura 129 mm



AS103SP

SEPARADOR AGUA COMBUSTIBLE

D. Exterior 74.8 mm
Rosca M20x1.5
Altura 152 mm



A243004DSP

SEPARADOR AGUA COMBUSTIBLE

D. Exterior 81.3 mm
Rosca M16x1.5 mm
Altura 150 mm



JAC 1040-1045 2013> DIESEL



AP2224

AIRE PRIMARIO

D. Exterior 224 mm
D. Interior 139 mm
Altura 248 mm



A2863SP

ACEITE

D. Exterior 93.7 mm
Rosca M20x1.5
Altura 111 mm



A243004SP

COMBUSTIBLE

D. Exterior 81.3 mm
Rosca M16x1.5 mm
Altura 125 mm



AS12228DSP

SEPARADOR AGUA COMBUSTIBLE

D. Exterior 81.3 mm
Rosca M16x1.5 mm
Altura 166 mm



JAC JHR POWER 2.8 Lts EURO IV / JAC 1035 2018> DIESEL 2.8 DI EURO IV



AP85051

AIRE PRIMARIO

D. Exterior 174 mm
D. Interior 98 mm
Altura 258 mm



A2863SP

ACEITE

D. Exterior 93.7 mm
Rosca M20x1.5
Altura 111 mm



A26000SP

COMBUSTIBLE

D. Exterior 93.7 mm
Rosca M16x1.5 mm
Altura 166 mm



AS200SP

SEPARADOR AGUA COMBUSTIBLE

D. Exterior 81.3 mm
Rosca M16x1.5 mm
Altura 166 mm

MD / MEDIANO

ICONOS



Aire

Aceite

Combustible

Separador Agua Combustible

Aire Cabina

Hidráulico

Refrigerante

Transmisión

Secador de Aire



JMC NEW CARRYING PLUS 1041; 1050; 1062 3.2 Y 4.5 TON JX1044TC4 2018-2021 ISUZU 4JB1 2.8 LTS DIESEL



AP39601
AIRE PRIMARIO

D. Exterior	172 mm
D. Interior	80 mm
Altura	266 mm

A2863SP
ACEITE

D. Exterior	93.7 mm
Rosca	M20x1.5
Altura	111 mm

A1226
SEPARADOR AGUA COMBUSTIBLE

D. Exterior	74.2 mm
Rosca	M16x1.5 mm
Altura	175 mm

AS200SP
SEPARADOR AGUA COMBUSTIBLE

D. Exterior	81.3 mm
Rosca	M16x1.5 mm
Altura	166 mm



JMC NEW CARRYING CHR 3.2 TON 2022 JMC 2.8 LTS JX493ZLQ4 TURBO



AP39601
AIRE PRIMARIO

D. Exterior	172 mm
D. Interior	80 mm
Altura	266 mm

A2863SP
ACEITE

D. Exterior	93.7 mm
Rosca	M20x1.5
Altura	111 mm

A1226
SEPARADOR AGUA COMBUSTIBLE

D. Exterior	74.2 mm
Rosca	M16x1.5 mm
Altura	175 mm

AS200SP
SEPARADOR AGUA COMBUSTIBLE

D. Exterior	81.3 mm
Rosca	M16x1.5 mm
Altura	166 mm



JMC JX1083 TK24 2022 JMC 2.8 LTS JX493ZLQ4 TURBO



AP39601
AIRE PRIMARIO

D. Exterior	172 mm
D. Interior	80 mm
Altura	266 mm

A2863SP
ACEITE

D. Exterior	93.7 mm
Rosca	M20x1.5
Altura	111 mm

A1226
SEPARADOR AGUA COMBUSTIBLE

D. Exterior	74.2 mm
Rosca	M16x1.5 mm
Altura	175 mm

AS200SP
SEPARADOR AGUA COMBUSTIBLE

D. Exterior	81.3 mm
Rosca	M16x1.5 mm
Altura	166 mm

JMC

KITS DE APLICACIÓN

MD / MEDIANO

ICONOS



MERCEDES BENZ ACCELO 915 CAMION 2001-> OM 914LA

AP20457 AIRE PRIMARIO	AP20457SY AIRE SECUNDARIO	PP7199 ACEITE	PP7735 COMBUSTIBLE	A1345SP SEP. AGUA COMBUSTIBLE	A7301DSP SEP. AGUA COMBUSTIBLE	ASV1060SP SEP. AGUA COMBUSTIBLE	AA5374 SECADOR DE AIRE
D. Exterior 200 mm D. Interior 96 mm Altura 382.5 mm	D. Exterior 92 mm D. Interior 75.8 mm Altura 367.5 mm	D. Exterior 83.4 mm D. Interior 39 mm Altura 150.4 mm	D. Exterior 91.7 mm D. Interior 27 mm Altura 100.5 mm	D. Exterior 107 mm Rosca 1x14 in Altura 170 mm	D. Exterior 107 mm Rosca 1x14 in Altura 193 mm	D. Exterior 107 mm Rosca 1x12 in Altura 245 mm	D. Exterior 135 mm Rosca M39x1.5 Altura 164 mm



MERCEDES BENZ OF 917 BUS 2020-> OM 904LA EURO V

AP80006 AIRE PRIMARIO	AP80006SY AIRE SEGURIDAD	A7028SP ACEITE	A70401SP COMBUSTIBLE	AS1441SP SEPARADOR AGUA COMBUSTIBLE
D. Exterior 196 mm D. Interior 119.5 mm Altura 360 mm	D. Exterior 129 mm D. Interior 106 mm Altura 365 mm	D. Exterior 107 mm Rosca M26x1.5 Altura 130 mm	D. Exterior 93.7 mm Rosca M23x1,5 mm Altura 121 mm	D. Exterior 81.3 mm Rosca M16x1.5 mm Altura 166 mm



MERCEDES BENZ ATEGO 813 2017> OM 904LA EURO V

AP25653 AIRE PRIMARIO	PP7199 ACEITE	PP7735 COMBUSTIBLE	ASV1060SP SEPARADOR AGUA COMBUSTIBLE	AA5374 SECADOR DE AIRE
D. Exterior 274 mm D. Interior 127 mm Altura 339 mm	D. Exterior 83.4 mm D. Interior 39 mm Altura 150.4 mm	D. Exterior 91.7 mm Rosca 27 mm Altura 100.5 mm	D. Exterior 107 mm Rosca 1x12 in Altura 245 mm	D. Exterior 135 mm Rosca M39x1.5 mm Altura 164 mm

MD / MEDIANO

ICONOS



Aire



Aceite



Combustible



Separador Agua Combustible



Aire Cabina



Hidráulico



Refrigerante



Transmisión



Secador de Aire



MERCEDES BENZ LO916 2015-2020 OM 924LA 4,8 LTS

AP20457 AIRE PRIMARIO	AP20457SY AIRE PRIMARIO	PP7199 ACEITE	PP7735 COMBUSTIBLE
D. Exterior 200 mm D. Interior 96 mm Altura 382.5 mm	D. Exterior 92 mm D. Interior 75.8 mm Altura 367.5 mm	D. Exterior 83.4 mm D. Interior 39 mm Altura 150.4 mm	D. Exterior 91.7 mm Rosca 27 mm Altura 100.5 mm



MERCEDES BENZ LO914- LO915 y 915L ALIMENTADOR 1417 2001 OM 904LA 4,2 LTS

AP20457 AIRE PRIMARIO	PP7199 ACEITE	PP7735 COMBUSTIBLE	AS0015SP SEPARADOR AGUA COMBUSTIBLE	ASV1060SP SEPARADOR AGUA COMBUSTIBLE
D. Exterior 200 mm D. Interior 96 mm Altura 382.5 mm	D. Exterior 83.4 mm D. Interior 39 mm Altura 150.4 mm	D. Exterior 91.7 mm Rosca 27 mm Altura 100.5 mm	D. Exterior 107 mm Rosca 1x12 in Altura 184 mm	D. Exterior 107 mm Rosca 1x12 in Altura 245 mm



MITSUBISHI CANTER 639: CAMION-MICROBUS 1997-2013 AD34 3,9Lt

AP7242 AIRE PRIMARIO	A092SP ACEITE	A292 COMBUSTIBLE	A3726SP COMBUSTIBLE
D. Exterior 230 mm D. Interior 120 mm Altura 281 mm	D. Exterior 107 mm Rosca M26x1.5 Altura 131 mm	D. Exterior 93.7 mm Rosca M20x1.5 Altura 84 mm	D. Exterior 93.7 mm Rosca M20x1.5 Altura 99 mm

MD /
MEDIANO

ICONOS



Aire



Aceite



Combustible



Separador Agua
Combustible



Aire Cabina



Hidráulico



Refrigerante



Transmisión



Secador
de Aire



MITSUBISHI CANTER FUSO CAMION 2016 2.7, 4.0 y 5.0T



AP7242

AIRE PRIMARIO

D. Exterior	230 mm
D. Interior	120 mm
Altura	281 mm



A1480

ACEITE

D. Exterior	107 mm
Rosca	M26x1.5
Altura	143 mm



PP22135

COMBUSTIBLE

D. Exterior	93.8 mm
D. Interior	26 mm
Altura	96.7 mm



MITSUBISHI CANTER FUSO CAMION 2018-2021 4M42 3AT2



AP7242

AIRE PRIMARIO

D. Exterior	230 mm
D. Interior	120 mm
Altura	281 mm



A7028SP

ACEITE

D. Exterior	107 mm
Rosca	M26x1.5
Altura	130 mm



PP22135

COMBUSTIBLE

D. Exterior	93.8 mm
D. Interior	26 mm
Altura	96.7 mm



AS46018SP

SEPARADOR AGUA
COMBUSTIBLE

D. Exterior	107 mm
Rosca	1x14 in
Altura	216 mm



MITSUBISHI FUSO FA 9.6 2017-2022 4D37 3,9 LTS EURO V



AP80006

AIRE PRIMARIO

D. Exterior	196 mm
D. Interior	119,5 mm
Altura	360 mm



AP80006SY

AIRE SEGURIDAD

D. Exterior	129 mm
D. Interior	106 mm
Altura	365 mm



A7028SP

ACEITE

D. Exterior	107 mm
Rosca	M26x1.5
Altura	130 mm



AS1441SP

SEPARADOR AGUA
COMBUSTIBLE

D. Exterior	81.3 mm
Rosca	M16x1.5 mm
Altura	166 mm

MITSUBISHI

KITS DE APLICACIÓN

MD / MEDIANO

ICONOS



Aire

Aceite

Combustible

Separador Agua Combustible

Aire Cabina

Hidráulico

Refrigerante

Transmisión

Secador de Aire



MITSUBISHI FUSO FA 9.0 / FI 10.4 2017-2022 4D37 - 125

MITSUBISHI

KITS DE APLICACIÓN

NISSAN



AP80006
AIRE PRIMARIO
D. Exterior 196 mm
D. Interior 119,5 mm
Altura 360 mm



AP80006SY
AIRE SEGURIDAD
D. Exterior 129 mm
D. Interior 106 mm
Altura 365 mm



A7028SP
ACEITE
D. Exterior 107 mm
Rosca M26x1.5
Altura 130 mm

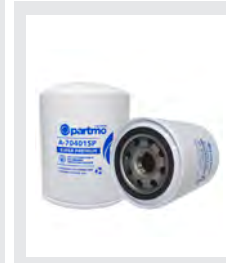

A70401SP
COMBUSTIBLE
D. Exterior 93.7 mm
Rosca M23x1,5 mm
Altura 121 mm



AS1441SP
SEPARADOR AGUA COMBUSTIBLE
D. Exterior 81.3 mm
Rosca M16x1.5 mm
Altura 166 mm



NISSAN CABSTAR III CABINA SENCILLA/DOBLE 2009 - 2012 ZD30; ZD30H 3.5 LTS

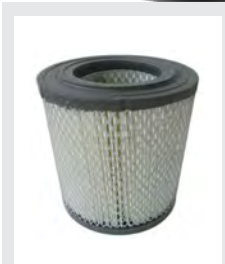

AP3270
AIRE PRIMARIO
D. Exterior 176 mm
D. Interior 95 mm
Altura 184 mm



PP2200
ACEITE
D. Exterior 76.6 mm
D. Interior 29 mm
Altura 104 mm



PFG448
COMBUSTIBLE
D. Exterior 98 mm
D. Entrada 10 mm
D. Salida 10 mm



A5368SP
SEPARADOR AGUA COMBUSTIBLE
D. Exterior 81.3 mm
Rosca 3/4x16 in
Altura 176 mm



NISSAN CAMIONES MT3000TI TURBO DIESEL 2006> TURBO DIESEL



APG4800
AIRE PRIMARIO
D. Exterior 148 mm
D. Interior 72 mm
Altura 332.5 mm



A1SP
ACEITE
D. Exterior 93.7 mm
Rosca 3/4x16 in
Altura 139 mm

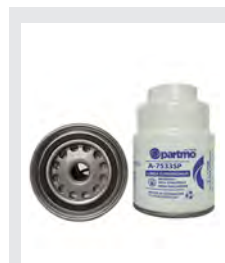

A7533SP
SEPARADOR AGUA COMBUSTIBLE
D. Exterior 93.7 mm
Rosca 3/4x16 in
Altura 139 mm



PP201030
COMBUSTIBLE
D. Exterior 79 mm
D. Interior 16 mm
Altura 76 mm

MD / MEDIANO

ICONOS



Aire



Aceite



Combustible



Separador Agua Combustible



Aire Cabina



Hidráulico



Refrigerante



Transmisión



Secador de Aire



NISSAN CABSTAR III 2017> ZD30; ZD30H 3.0 LTS



	APG4800
	AIRE PRIMARIO
D. Exterior	148 mm
D. Interior	72 mm
Altura	332.5 mm



	A1SP
	ACEITE
D. Exterior	93.7 mm
Rosca	3/4x16 in
Altura	139 mm



	PFG448
	COMBUSTIBLE
D. Exterior	98 mm
D. Entrada	10 mm
D. Salida	10 mm



NISSAN TK55 MICRO BUS-BUSETA 2010-2014 YD 25 3.0 DIÉSEL



	AP3270
	AIRE PRIMARIO
D. Exterior	176 mm
D. Interior	95 mm
Altura	184 mm



	PP2200
	ACEITE
D. Exterior	76.6 mm
D. Interior	29 mm
Altura	104 mm

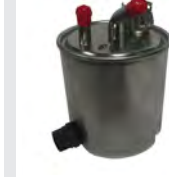

	PFG448
	COMBUSTIBLE
D. Exterior	98 mm
D. Entrada	10 mm
D. Salida	10 mm



	A5368SP
	SEPARADOR AGUA COMBUSTIBLE
D. Exterior	81.3 mm
Rosca	3/4x16 in
Altura	176 mm



	PP201030
	SEPARADOR AGUA COMBUSTIBLE
D. Exterior	79 mm
D. Interior	16 mm
Altura	76 mm



SINOTRUK HOWO 5 TON 2019> CUMMINS ISF 3.8



	AP8213
	AIRE PRIMARIO
D. Exterior	199 mm
D. Interior	172 mm
Altura	300 mm



	AP8213SY
	AIRE SEGURIDAD
D. Exterior	142 mm
D. Interior	100 mm
Altura	277 mm



	A7898SP
	ACEITE
D. Exterior	93.7 mm
Rosca	M26x1.5
Altura	178 mm



	PP5706
	COMBUSTIBLE
D. Exterior	100 mm
Rosca	M100x4 7H mm
Altura	213 mm



	AS1003SP
	SEPARADOR AGUA COMBUSTIBLE
D. Exterior	93.7 mm
Rosca	1x14 in
Altura	258 mm

MD / MEDIANO

ICONOS



Aire

Aceite

Combustible

Separador Agua Combustible

Aire Cabina

Hidráulico

Refrigerante

Transmisión

Secador de Aire



SINOTRUK HOWO 2.8 TON 2019 JE493ZLQ4- 2.8 LTS



AP8213
AIRE PRIMARIO
D. Exterior 199 mm
D. Interior 172 mm
Altura 300 mm



AP8213SY
AIRE SEGURIDAD
D. Exterior 142 mm
D. Interior 100 mm
Altura 277 mm



A2863SP
ACEITE
D. Exterior 93.7 mm
Rosca M20x1.5
Altura 111 mm



AS200SP
SEPARADOR AGUA COMBUSTIBLE
D. Exterior 81.3 mm
Rosca M16x1.5 mm
Altura 81.3 mm



SINOTRUK HOWO 7 TON 2020 CUMMINS ISF 3.8 EURO IV



AP8213
AIRE PRIMARIO
D. Exterior 199 mm
D. Interior 172 mm
Altura 300 mm



AP8213SY
AIRE SEGURIDAD
D. Exterior 142 mm
D. Interior 100 mm
Altura 277 mm



A7898SP
ACEITE
D. Exterior 93.7 mm
Rosca M26x1.5
Altura 178 mm



PP5706
COMBUSTIBLE
D. Exterior 100 mm
Rosca M100x4 7H mm
Altura 213 mm



AS1228SP
SEPARADOR AGUA COMBUSTIBLE
D. Exterior 107 mm
Rosca 1x14 in
Altura 164 mm



VOLKSWAGEN 8-160 WORKER 2017 CUMMINS ISF 3.8 SCR 3.8 LTS EURO IV



AP17308
AIRE PRIMARIO
D. Exterior 167 mm
D. Interior 109mm
Altura 384.3 mm



APC203252SY
AIRE SEGURIDAD
D. Exterior 95 mm
D. Interior 89 mm
Altura 374 mm



A7898SP
ACEITE
D. Exterior 93.7 mm
Rosca M26x1.5
Altura 178 mm



PP5706
COMBUSTIBLE
D. Exterior 100 mm
Rosca M100x4 7H mm
Altura 213 mm



AS27177JSP
SEPARADOR AGUA COMBUSTIBLE
D. Exterior 107 mm
Rosca 1x14 in
Altura 164 mm

MD / MEDIANO

ICONOS



Aire



Aceite



Combustible



Separador Agua Combustible



Aire Cabina



Hidráulico



Refrigerante



Transmisión



Secador de Aire



VOLKSWAGEN 9-150 MOTOR MWM 2006> MWM



AP17308

AIRE PRIMARIO

D. Exterior 167 mm
D. Interior 109 mm
Altura 384.3 mm



A840SP

ACEITE

D. Exterior 93.7 mm
Rosca 1x12 in
Altura 205 mm



A830

COMBUSTIBLE

D. Exterior 107 mm
Rosca 1x14 in
Altura 131 mm



A950DSP

SEPARADOR AGUA COMBUSTIBLE

D. Exterior 93.7 mm
Rosca 1x14 in
Altura 212 mm



VOLKSWAGEN 9-160 OD VOLKSBUS / DELIVERY 9-170 / 11-180 2017> CUMMINS ISF SCR 3.8 LTS EURO V



AP17308

AIRE PRIMARIO

D. Exterior 167 mm
D. Interior 109mm
Altura 384.3 mm



APC203252SY

AIRE SEGURIDAD

D. Exterior 95 mm
D. Interior 89 mm
Altura 374 mm



A7898SP

ACEITE

D. Exterior 93.7 mm
Rosca M26x1.5
Altura 178 mm



PP5706

COMBUSTIBLE

D. Exterior 100 mm
Rosca M100x4 7H mm
Altura 213 mm



AS27177JSP

SEPARADOR AGUA COMBUSTIBLE

D. Exterior 107 mm
Rosca 1x14 in
Altura 164 mm



VOLKSWAGEN DELIVERY 10-160 2017 CUMMINS ISF 3.8 EURO V



AP17308

AIRE PRIMARIO

D. Exterior 167 mm
D. Interior 109mm
Altura 384.3 mm



APC203252SY

AIRE SEGURIDAD

D. Exterior 95 mm
D. Interior 89 mm
Altura 374 mm



A7898SP

ACEITE

D. Exterior 93.7 mm
Rosca M26x1.5
Altura 178 mm



PP5706

COMBUSTIBLE

D. Exterior 100 mm
Rosca M100x4 7H mm
Altura 213 mm



AS27177JSP

SEPARADOR AGUA COMBUSTIBLE

D. Exterior 107 mm
Rosca 1x14 in
Altura 164 mm



AA5374

SECADOR DE AIRE

D. Exterior 135 mm
Rosca M39x1.5 mm
Altura 164 mm

MD / MEDIANO

ICONOS



Aire



Aceite



Combustible



Separador Agua Combustible



Aire Cabina



Hidráulico



Refrigerante



Transmisión



Secador de Aire



YUTONG ZK 6107HA 2012> CUMMINS ISD 245 EURO III ELECT



AP12020
AIRE PRIMARIO

D. Exterior	301 mm
D. Interior	191 mm
Altura	472 mm

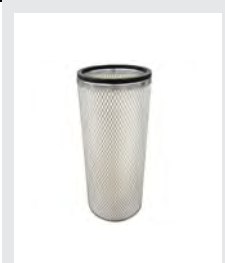

AP12020SY
AIRE SEGURIDAD

D. Exterior	186 mm
D. Interior	156 mm
Altura	445 mm

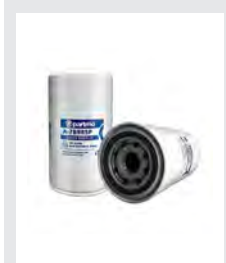

A7898SP
ACEITE

D. Exterior	93.7 mm
Rosca	M26x1.5
Altura	178 mm



A7813SP
COMBUSTIBLE

D. Exterior	93.7 mm
Rosca	M20x1.5
Altura	178 mm

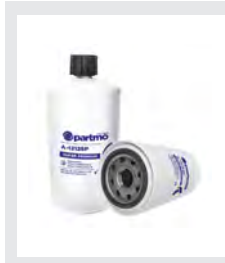

A1212SP
SEPARADOR AGUA COMBUSTIBLE

D. Exterior	93.7 mm
Rosca	1x14 in
Altura	192 mm

YUTONG

KITS DE APLICACIÓN



ES JUSTO

LO QUE NECESITAS

KITS DE APLIACIÓN SEGMENTO LIVIANO DIÉSEL

**Vehículos de carga y pasajeros
hasta 2 toneladas o máximo 19 pasajeros**

**SOLUCIONES EN FILTRACIÓN
PARA TRANSPORTE MEDIANO**

LDD /
LIVIANO
DIÉSEL

ICONOS



Aire



Aceite



Combustible



Separador Agua
Combustible



Aire Cabina



Hidráulico



Refrigerante



Transmisión



Secador
de Aire



CHEVROLET LUV D-MAX 4x2, 4x4 DLS 2005-2010 2.5 y 3.0 Lt



AP16550

AIRE PRIMARIO

D. Exterior	168 mm
D. Interior	80 mm
Altura	144 mm



A4050PLUS

ACEITE

D. Exterior	81.3 mm
Rosca	3/4x16 in
Altura	112 mm



A4053SP

COMBUSTIBLE

D. Exterior	81.3 mm
Rosca	3/4x16 in
Altura	90 mm



A7533C

SEPARADOR AGUA
COMBUSTIBLE

D. Exterior	81.3 mm
Rosca	3/4x16 in
Altura	85 mm



CHEVROLET LUV D-MAX RT 50 4x2, 4x4 DLS 2013-2021 ISUZU 4JK1 TC 2.5 Lts



AP352660

AIRE PRIMARIO

Altura	57 mm
Ancho	238 mm
Longitud	253 mm



A8720CSP

ACEITE

D. Exterior	81.3 mm
Rosca	M26x1.5
Altura	100 mm



PP7355

COMBUSTIBLE

D. Exterior	84 mm
D. Interior	9 mm
Altura	75.3 mm



FORD RANGER TDCI 2013-2021 2.2 - 3.2



AP35892

AIRE PRIMARIO

D. Exterior	222 mm
D. Interior	135 mm
Altura	140 mm



PP16328

ACEITE

D. Exterior	64 mm
D. Interior	31 mm
Altura	69 mm



PP176AC

COMBUSTIBLE

D. Exterior	83.6 mm
D. Interior	12 mm
Altura	85 mm

LDD /
LIVIANO
DIÉSEL

ICONOS



Aire



Aceite



Combustible



Separador Agua
Combustible



Aire Cabina



Hidráulico



Refrigerante



Transmisión



Secador
de Aire



FOTON TUNLAND MECANICA 2012-2014 2.8 Diesel

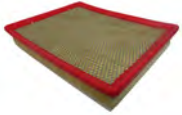

AP35915

AIRE PRIMARIO

Altura	55 mm
Ancho	260 mm
Longitud	320 mm



PP17356

ACEITE

D. Exterior	101 mm
Rosca	M67x4 mm
Altura	156 mm



PP19925

COMBUSTIBLE

D. Exterior	81 mm
D. Interior	30 mm
Altura	127 mm



FOTON VIEW VANS DIESEL 2016> DIESEL 2,800 CC



AP8054

AIRE PRIMARIO

D. Exterior	155 mm
D. Interior	89 mm
Altura	290 mm



A2863SP

ACEITE

D. Exterior	93.7 mm
Rosca	M20x1.5
Altura	111 mm



AS200SP

COMBUSTIBLE

D. Exterior	81.3 mm
Rosca	M16x1.5 mm
Altura	166 mm



FOTON VIEW VANS DIESEL BJ483ZQB 2007-2010 DIESEL 2,200 CC



AP2217

AIRE PRIMARIO

D. Exterior	132 mm
D. Interior	84 mm
Altura	284 mm



A1SP

ACEITE

D. Exterior	93.7 mm
Rosca	3/4x16 in
Altura	139 mm



A4053SP

COMBUSTIBLE

D. Exterior	81.3 mm
Rosca	3/4x16 in
Altura	90 mm

LDD /
LIVIANO
DIÉSEL

ICONOS



Aire

Aceite

Combustible

Separador Agua
Combustible

Aire Cabina

Hidráulico

Refrigerante

Transmisión

Secador
de Aire



GOLDEN DRAGON VANS PANEL PASAJEROS 2011-2022 2,8 CC DIESEL

GOLDEN DRAGON

KITS DE APLICACIÓN

GREAT WALL

HYUNDAI

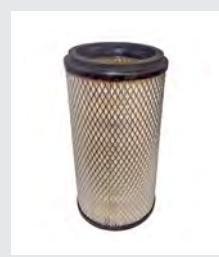

	AP8054
	AIRE PRIMARIO
D. Exterior	155 mm
D. Interior	89 mm
Altura	290 mm



	A4044
	ACEITE
D. Exterior	93.7 mm
Rosca	M20x1.5
Altura	108 mm



	AS200SP
	SEPARADOR AGUA COMBUSTIBLE
D. Exterior	81.3 mm
Rosca	M16x1.5 mm
Altura	166 mm



	PM6630
	SEPARADOR AGUA COMBUSTIBLE
D. Exterior	74.6 mm
D. Interior	10 mm
Altura	46.5 mm



GREAT WALL WINGLE 5 DIESEL 2017 2.0 LTS



	AP3171
	AIRE PRIMARIO
Altura	45 mm
Ancho	190 mm
Longitud	270 mm



	A329
	ACEITE
D. Exterior	93.7 mm
Rosca	M22x1.5
Altura	97 mm

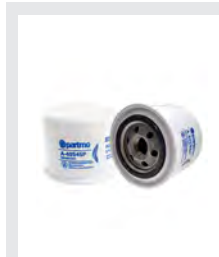

	A4054SP
	COMBUSTIBLE
D. Exterior	81.3 mm
Rosca	3/4x16 in
Altura	76 mm



	AS200SP
	SEPARADOR AGUA COMBUSTIBLE
D. Exterior	81.3 mm
Rosca	M16x1.5 mm
Altura	166 mm



HYUNDAI H1 2010-2013 2.4 LTS



	AP3532
	AIRE PRIMARIO
D. Exterior	255 mm
D. Interior	145 mm
Altura	137 mm

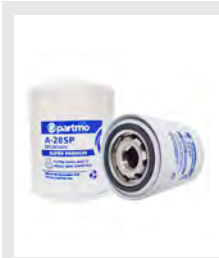

	A28SP
	ACEITE
D. Exterior	93.7 mm
Rosca	M26x1.5
Altura	120 mm



	AS201SP
	SEPARADOR AGUA COMBUSTIBLE
D. Exterior	81.3 mm
Rosca	M16x1.5 mm
Altura	143 mm

LDD /
LIVIANO
DIÉSEL

ICONOS



Aire

Aceite

Combustible

Separador Agua
Combustible

Aire Cabina

Hidráulico

Refrigerante

Transmisión

Secador
de Aire



HYUNDAI SANTA FE ADVANCE DIESEL 2013-2017 2.2 LTS

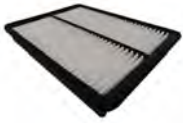

AP31920
AIRE PRIMARIO

Altura	37 mm
Ancho	197 mm
Longitud	294 mm

PP2F000
ACEITE

D. Exterior	65.4 mm
D. Interior	18 mm
Altura	131.6 mm

AS200SP
SEPARADOR AGUA
COMBUSTIBLE

D. Exterior	81.3 mm
Rosca	M16x1.5 mm
Altura	166 mm

AP31029
AIRE CABINA

Altura	17 mm
Ancho	254 mm
Longitud	220 mm



HYUNDAI STAREX H1 - GRAND STAREX TQ VANS 2008-2022 2.5 lts



AP3107
AIRE PRIMARIO

Altura	51 mm
Ancho	189 mm
Longitud	270 mm

A28SP
ACEITE

D. Exterior	93.7 mm
Rosca	M26x1.5
Altura	120 mm

AS201SP
SEPARADOR AGUA
COMBUSTIBLE

D. Exterior	81.3 mm
Rosca	M16x1.5 mm
Altura	143 mm

AP31006
AIRE CABINA

Altura	42 mm
Ancho	150 mm
Longitud	180 mm



HYUNDAI STAREX H1 Diesel 2005-2008 2.6 LTS



AP4001
AIRE PRIMARIO

D. Exterior	232 mm
D. Interior	135 mm
Altura	188.5 mm

A28SP
ACEITE

D. Exterior	93.7 mm
Rosca	M26x1.5
Altura	120 mm

AK570SP
COMBUSTIBLE

D. Exterior	93.7 mm
Rosca	M20x1.5
Altura	139 mm

LDD /
LIVIANO
DIÉSEL

ICONOS



HYUNDAI TUCSON IX 35 Diesel 2015 2.0 LTS

AP31985 AIRE PRIMARIO	A53PLUS ACEITE	AP31739 AIRE CABINA
Altura 41 mm Ancho 171 mm Longitud 275 mm	D. Exterior 81.3 mm Rosca M20x1.5 Altura 89 mm	Altura 17 mm Ancho 200 mm Longitud 226 mm



JAC JOYLONG 2015> Cumm ISF 2.8 LTS

AP8054 AIRE PRIMARIO	PP17356 ACEITE	A243004SP COMBUSTIBLE	AS36209SP SEPARADOR AGUA COMBUSTIBLE
D. Exterior 155 mm D. Interior 89 mm Altura 290 mm	D. Exterior 101 mm Rosca M67x4 mm Altura 156 mm	D. Exterior 81.3 mm Rosca M16x1.5 mm Altura 125 mm	D. Exterior 93.7 mm Rosca M20x1.5 Altura 203 mm



JINBEI H1 2007-2016 2,5 CC DIESEL

AP2217 AIRE PRIMARIO	A48SP ACEITE	AS200SP SEPARADOR AGUA COMBUSTIBLE
D. Exterior 132 mm D. Interior 84 mm Altura 284 mm	D. Exterior 93.7 mm Rosca 1x12 in Altura 165 mm	D. Exterior 81.3 mm Rosca M16x1.5 mm Altura 166 mm

HYUNDAI

KITS DE APLICACIÓN

JAC

JINBEI

LDD /
LIVIANO
DIÉSEL

ICONOS



Aire



Aceite



Combustible



Separador Agua
Combustible



Aire Cabina



Hidráulico



Refrigerante



Transmisión



Secador
de Aire



KIA K 2700 / K3000 2010-2019 2.7Lt / 3.0 LTS



AP2959

AIRE PRIMARIO

D. Exterior	178 mm
D. Interior	109 mm
Altura	246.2 mm



A28SP

ACEITE

D. Exterior	93.7 mm
Rosca	M26x1.5
Altura	120 mm



AK570SP

COMBUSTIBLE

D. Exterior	93.7 mm
Rosca	M20x1.5
Altura	139 mm



KIA PREGIO 2,7 VAN 2010-2016 2.7 LTS



AP2959

AIRE PRIMARIO

D. Exterior	178 mm
D. Interior	109 mm
Altura	246.2 mm



A28SP

ACEITE

D. Exterior	93.7 mm
Rosca	M26x1.5
Altura	120 mm



A093SP

SEPARADOR AGUA
COMBUSTIBLE

D. Exterior	81.3 mm
Rosca	M20x1.5
Altura	119 mm



KIA SORENTO TRUST 2014-2015 2.2 LTS



AP31900

AIRE PRIMARIO

Altura	36 mm
Ancho	227 mm
Longitud	300 mm



PP2F000

ACEITE

D. Exterior	65.4 mm
D. Interior	18 mm
Altura	131.6 mm



AP31012

AIRE CABINA

Altura	22 mm
Ancho	109 mm
Longitud	219 mm

LDD /
LIVIANO
DIÉSEL

ICONOS



Aire



Aceite



Combustible



Separador Agua
Combustible



Aire Cabina



Hidráulico



Refrigerante



Transmisión



Secador
de Aire



KIA SPORTAGE 2017-2021 2.0 LTS



	AP31985
	AIRE PRIMARIO
Altura	41 mm
Ancho	177 mm
Longitud	275 mm



	A53PLUS
	ACEITE
D. Exterior	81.3 mm
Rosca	M20x1.5
Altura	89 mm



	AP43100
	AIRE CABINA
Altura	28 mm
Ancho	198 mm
Longitud	228 mm



KIA SPORTAGE 2017-2021 2.0 LTS

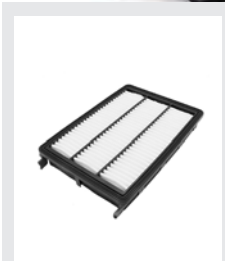

	AP31980
	AIRE PRIMARIO
Altura	41 mm
Ancho	195 mm
Longitud	275 mm



	A53PLUS
	ACEITE
D. Exterior	81.3 mm
Rosca	M20x1.5
Altura	89 mm



	AS201SP
	SEPARADOR AGUA COMBUSTIBLE
D. Exterior	81.3 mm
Rosca	M16x1.5 mm
Altura	143 mm



KIA SPORTAGE HIBRIDO 2020-2021 1.6 LTS



	AP31985
	AIRE PRIMARIO
Altura	41 mm
Ancho	177 mm
Longitud	275 mm



	A53PLUS
	ACEITE
D. Exterior	81.3 mm
Rosca	M20x1.5
Altura	89 mm

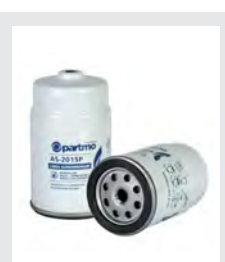

	AS201SP
	SEPARADOR AGUA COMBUSTIBLE
D. Exterior	81.3 mm
Rosca	M16x1.5 mm
Altura	143 mm



	AP43100
	AIRE CABINA
Altura	28 mm
Ancho	198 mm
Longitud	228 mm

LDD / LIVIANO DIÉSEL

ICONOS



MAHINDRA SCORPIUS PICK UP 2011-2016 2.2 Turbo Diesel

AP3597 AIRE PRIMARIO	A4044 ACEITE	P346P SEPARADOR AGUA COMBUSTIBLE	AS200SP SEPARADOR AGUA COMBUSTIBLE
Altura 58 mm Ancho 192 mm Longitud 345 mm	D. Exterior 93.7 mm Rosca M20x1.5 Altura 108 mm	D. Exterior 84.3 mm D. (E/S) 14mm / 14mm Altura 74 mm	D. Exterior 81.3 mm Rosca M16x1.5 mm Altura 166 mm



MAZDA BT 50 2008-2013 WLAT 2.5 Diesel

APC010 AIRE PRIMARIO	A14302PLUS ACEITE	A7533DSP SEPARADOR AGUA COMBUSTIBLE
D. Exterior 215 mm D. Interior 123 mm Altura 175 mm	D. Exterior 76.4 mm Rosca 3/4x16 in Altura 97 mm	D. Exterior 93.7 mm Rosca 3/4x16 in Altura 162 mm



MAZDA BT 50 Diesel 2013-2017 2.2 / 3.2

AP35892 AIRE PRIMARIO	PP16328 ACEITE	PP176AC COMBUSTIBLE
D. Exterior 222 mm D. Interior 135 mm Altura 140 mm	D. Exterior 64 mm D. Interior 31 mm Altura 69 mm	D. Exterior 83.6 mm D. Interior 12 mm Altura 85 mm

LDD /
LIVIANO
DIÉSEL

ICONOS



Aire



Aceite



Combustible



Separador Agua
Combustible



Aire Cabina



Hidráulico



Refrigerante



Transmisión



Secador
de Aire



MERCEDES BENZ SPRINTER 413 VAN PANEL 2002-2007 OM 611



	AP3570
	AIRE PRIMARIO
Altura	192 mm
Ancho	112 mm
Longitud	302 mm



	PP7181
	ACEITE
D. Exterior	64 mm
D. Interior	28 mm
Altura	115 mm



	PP201030
	SEPARADOR AGUA COMBUSTIBLE
D. Exterior	79 mm
D. Interior	16 mm
Altura	76 mm



	AP31001
	AIRE CABINA
Altura	25 mm
Ancho	169 mm
Longitud	375 mm



MERCEDES BENZ SPRINTER 415 CDI 2007-2016 DIESEL 2,2 CDI



	AP35756
	AIRE PRIMARIO
Altura	57.5 mm
Ancho	264 mm
Longitud	349 mm

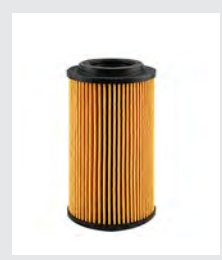

	PP7181
	ACEITE
D. Exterior	65 mm
D. Interior	31 mm
Altura	115 mm



	PFG469
	COMBUSTIBLE
D. Exterior	86.5 mm
D. (E/S)	8 mm / 10 mm
Altura	128 mm



	AP31084
	AIRE CABINA
Altura	50 mm
Ancho	235 mm
Longitud	350 mm



MERCEDES BENZ SPRINTER 515 2013-2015 DIESEL 3.0



	AP35756
	AIRE PRIMARIO
Altura	57.5 mm
Ancho	264 mm
Longitud	349 mm

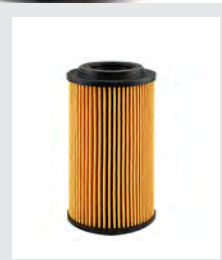

	PP7181
	ACEITE
D. Exterior	65 mm
D. Interior	31 mm
Altura	115 mm



	PFG469
	COMBUSTIBLE
D. Exterior	86.5 mm
D. (E/S)	8 mm / 10 mm
Altura	128 mm



	AP31084
	AIRE CABINA
Altura	50 mm
Ancho	235 mm
Longitud	350 mm

LDD / LIVIANO DIÉSEL

ICONOS



MERCEDES BENZ SPRINTER 516 2020-2021 OM651LA 2.1 LTS 163 HP



	AP35756 AIRE PRIMARIO
Altura	57.5 mm
Ancho	264 mm
Longitud	349 mm

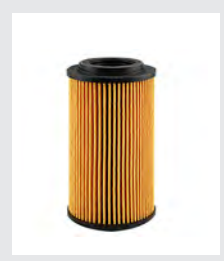

	PP7181 ACEITE
D. Exterior	65 mm
D. Interior	31 mm
Altura	115 mm



	PFG469 COMBUSTIBLE
D. Exterior	86.5 mm
D. (E/S)	8 mm / 10 mm
Altura	128 mm



MITSUBISHI NATIVA 2009-2016 3.2 Diesel



	AP3115 AIRE PRIMARIO
Altura	63.5 mm
Ancho	239 mm
Longitud	239 mm

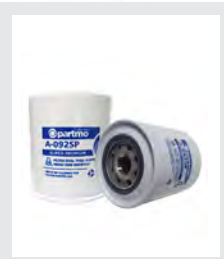

	A092SP ACEITE
D. Exterior	101 mm
Rosca	M26x1.5
Altura	131 mm

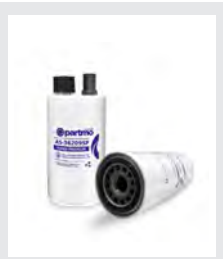

	A7533SP SEPARADOR AGUA COMBUSTIBLE
D. Exterior	93.7 mm
Rosca	3/4x16 in
Altura	139 mm



MITSUBISHI SPORTERO L200 2012-2018 2.5 Diesel



	AP3115 AIRE PRIMARIO
Altura	63.5 mm
Ancho	239 mm
Longitud	239 mm

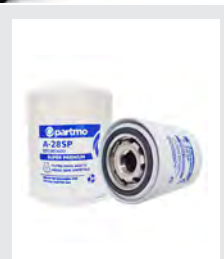

	A28SP ACEITE
D. Exterior	93.7 mm
Rosca	M26x1.5
Altura	120 mm



	PP7355 COMBUSTIBLE
D. Exterior	84 mm
D. Interior	9 mm
Altura	75.3 mm



	AK570SP SEPARADOR AGUA COMBUSTIBLE
D. Exterior	93.7 mm
Rosca	M20x1.5
Altura	139 mm

LDD / LIVIANO DIÉSEL

ICONOS



Aire

Aceite

Combustible

Separador Agua Combustible

Aire Cabina

Hidráulico

Refrigerante

Transmisión

Secador de Aire



NISSAN FRONTIER D22 4X4 2004-2012 3.0 Lts TURBO

AP9S001 AIRE PRIMARIO	PP2200 ACEITE	A7614SP COMBUSTIBLE	ASV1282SP SEPARADOR AGUA COMBUSTIBLE	A5368SP SEPARADOR AGUA COMBUSTIBLE	AP31060 AIRE CABINA
D. Exterior 135 mm D. Interior 72 mm Altura 230 mm	D. Exterior 76.6 mm D. Interior 29 mm Altura 104 mm	D. Exterior 93.7 mm Rosca 3/4x16 in Altura 134 mm	D. Exterior 93.7 mm Rosca 1x14 in Altura 185 mm	D. Exterior 81.3 mm Rosca 3/4x16 in Altura 176 mm	Altura 25 mm Ancho 100 mm Longitud 255 mm



NISSAN FRONTIER NP300 2008-2015 2.5 LTS / 3.0 LTS

AP9S001 AIRE PRIMARIO	A20PLUS ACEITE	A7614SP COMBUSTIBLE	ASV1282SP SEPARADOR AGUA COMBUSTIBLE	A7533SP SEPARADOR AGUA COMBUSTIBLE	AP31060 AIRE CABINA
D. Exterior 135 mm D. Interior 72 mm Altura 230 mm	D. Exterior 93.7 mm Rosca 3/4x16 in Altura 108 mm	D. Exterior 93.7 mm Rosca 3/4x16 in Altura 134 mm	D. Exterior 93.7 mm Rosca 1x14 in Altura 185 mm	D. Exterior 93.7 mm Rosca 3/4x16 in Altura 139 mm	Altura 25 mm Ancho 100 mm Longitud 255 mm



NISSAN FRONTIER NP300 2016-2023 YD25 2.5 LTS EURO IV

AP35961 AIRE PRIMARIO	A20PLUS ACEITE	PP80472 COMBUSTIBLE	AP31123 AIRE CABINA
Altura 48 mm Ancho 202 mm Longitud 256 mm	D. Exterior 93.7 mm Rosca 3/4x16 in Altura 108 mm	D. Exterior 81 mm D. Interior 10 mm Altura 161 mm	Altura 32 mm Ancho 201 mm Longitud 217 mm

NISSAN

KITS DE APLICACIÓN

LDD / LIVIANO DIÉSEL

ICONOS



Aire

Aceite

Combustible

Separador Agua Combustible

Aire Cabina

Hidráulico

Refrigerante

Transmisión

Secador de Aire

NISSAN



NISSAN NAVARA D22 2009-2014 TD27 2.5 Diesel



	AP3127
	AIRE PRIMARIO
Altura	45 mm
Ancho	188 mm
Longitud	265 mm



	A20PLUS
	ACEITE
D. Exterior	93.7 mm
Rosca	3/4x16 in
Altura	108 mm



	A7533DSP
	SEPARADOR AGUA COMBUSTIBLE
D. Exterior	93.7 mm
Rosca	3/4x16 in
Altura	162 mm



	A5368SP
	SEPARADOR AGUA COMBUSTIBLE
D. Exterior	81.3 mm
Rosca	3/4x16 in
Altura	176 mm

KITS DE APLICACIÓN



NISSAN URVAN 2006-2015 DIESEL 3.0 LTS



	AP101222K
	AIRE PRIMARIO
D. Exterior	132 mm
D. Interior	71 mm
Altura	132 mm



	PP2200
	ACEITE
D. Exterior	76.6 mm
D. Interior	29 mm
Altura	104 mm



	A7533SP
	SEPARADOR AGUA COMBUSTIBLE
D. Exterior	93.7 mm
Rosca	3/4x16 in
Altura	139 mm



	AS1282SP
	SEPARADOR AGUA COMBUSTIBLE
D. Exterior	93.7 mm
Rosca	1x14 in
Altura	177 mm



	AP43100
	AIRE CABINA
Altura	28 mm
Ancho	198 mm
Longitud	228 mm

RENAULT



RENAULT MASTER IV 2013-2021 2.3Lts, 130HP, M9T Euro 5/6



	AP31963
	AIRE PRIMARIO
D. Exterior	75 mm
D. Interior	200 mm
Altura	293 mm



	PP62442
	ACEITE
D. Exterior	58 mm
D. Interior	24 mm
Altura	113 mm



	PP80468
	SEPARADOR AGUA COMBUSTIBLE
D. Exterior	88 mm
D. Interior	11 mm
Altura	142 mm

LDD /
LIVIANO
DIÉSEL

ICONOS



Aire



Aceite



Combustible



Separador Agua
Combustible



Aire Cabina



Hidráulico



Refrigerante



Transmisión



Secador
de Aire



RENAULT MASTER III 2012-2015 2.5 Diesel



	AP35800
	AIRE PRIMARIO
D. Exterior	60 mm
D. Interior	247 mm
Altura	283 mm



	PP72321
	ACEITE
D. Exterior	91 mm
D. Interior	35 mm
Altura	92 mm



	PM4094
	COMBUSTIBLE
D. Exterior	70 mm
D. Interior	19 mm
Altura	88 mm



RENAULT TRAFIC III 2015-2017 1.6 Diesel



	AP31976
	AIRE PRIMARIO
D. Exterior	70 mm
D. Interior	209 mm
Altura	259 mm



	PP62442
	ACEITE
D. Exterior	58 mm
D. Interior	24 mm
Altura	113 mm

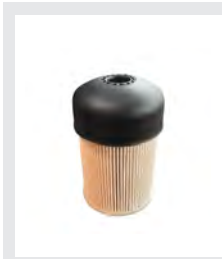

	PP80468
	SEPARADOR AGUA COMBUSTIBLE
D. Exterior	88 mm
D. Interior	11 mm
Altura	142 mm



	AP31136
	AIRE CABINA
Altura	35 mm
Ancho	195 mm
Longitud	261 mm



SSANGYONG KORANDO C 2011-2016 2.0 Diesel

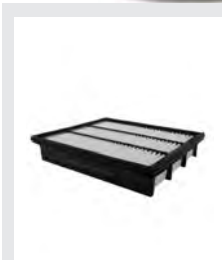

	AP31935
	AIRE PRIMARIO
D. Exterior	55 mm
D. Interior	237 mm
Altura	298 mm

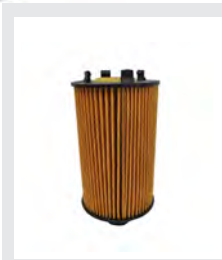

	PP03009
	ACEITE
D. Exterior	62 mm
D. Interior	22 mm
Altura	127 mm

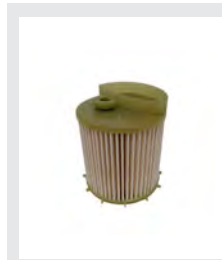

	PP7455
	COMBUSTIBLE
D. Exterior	95 mm
Rosca	0 mm
Altura	101 mm

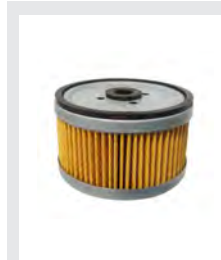

	PM6630
	SEPARADOR AGUA COMBUSTIBLE
D. Exterior	74.6 mm
D. Interior	10 mm
Altura	46.5 mm

SSANGYONG

KITS DE APLICACIÓN

TOYOTA

LDD / LIVIANO DIÉSEL

ICONOS



Aire

Aceite

Combustible

Separador Agua Combustible

Aire Cabina

Hidráulico

Refrigerante

Transmisión

Secador de Aire



SSANGYONG KYRON 2006-2014 2.0 Diesel

AP3599 AIRE PRIMARIO	PP40425 ACEITE	PFG422 COMBUSTIBLE	PM6630 SEPARADOR AGUA COMBUSTIBLE
D. Exterior 57 mm D. Interior 238 mm Altura 300 mm	D. Exterior 60 mm D. Interior 23 mm Altura 160 mm	D. Exterior 80 mm D. (E/S) 90 mm / 90mm Altura 175 mm	D. Exterior 74.6 mm D. Interior 10 mm Altura 46.5 mm



TOYOTA FORTUNER 2008-2014 3.0 Diesel

APC010 AIRE PRIMARIO	A14302PLUS ACEITE	PP7355 COMBUSTIBLE	AP31070 AIRE CABINA
D. Exterior 215 mm D. Interior 123 mm Altura 175 mm	D. Exterior 76.4 mm Rosca 3/4x16 in Altura 97 mm	D. Exterior 84 mm D. Interior 9 mm Altura 75.3 mm	Altura 31 mm Ancho 192 mm Longitud 213 mm



TOYOTA HILUX 2.8 LTS / FORTUNER 2.7 2017-2022 2,8 LTS 1GD / 2.7 LTS

AP35977 AIRE PRIMARIO	A14302PLUS ACEITE	PP7476 COMBUSTIBLE	AP31138 AIRE CABINA
Altura 215 mm Ancho 123 mm Longitud 175 mm	D. Exterior 76.4 mm Rosca 3/4x16 in Altura 97 mm	D. Exterior 88.8 mm D. Interior 25 mm Altura 110 mm	Altura 30 mm Ancho 187 mm Longitud 216 mm

LDD /
LIVIANO
DIÉSEL

ICONOS



Aire



Aceite



Combustible



Separador Agua
Combustible



Aire Cabina



Hidráulico



Refrigerante



Transmisión



Secador
de Aire



TOYOTA HILUX VIGO D4D - HIGH RIDER DIESEL 2006-2010 2.5 Diesel



APC010

AIRE PRIMARIO

D. Exterior	215 mm
D. Interior	123 mm
Altura	175 mm



A14302PLUS

ACEITE

D. Exterior	76.4 mm
Rosca	3/4x16 in
Altura	97 mm



PP7355

COMBUSTIBLE

D. Exterior	84 mm
D. Interior	9 mm
Altura	75.3 mm



AP31071

AIRE CABINA

Altura	29 mm
Ancho	195 mm
Longitud	214 mm



TOYOTA HILUX DIESEL 2006-2011 3.0 LTS



APC010

AIRE PRIMARIO

D. Exterior	215 mm
D. Interior	123 mm
Altura	175 mm



A14302PLUS

ACEITE

D. Exterior	76.4 mm
Rosca	3/4x16 in
Altura	97 mm



A7533SP

SEPARADOR AGUA
COMBUSTIBLE

D. Exterior	93.7 mm
Rosca	3/4x16 in
Altura	139 mm



TOYOTA PRADO TX / VX 2010-2021 3.0 LTS



AP3134

AIRE PRIMARIO

Altura	51 mm
Ancho	230 mm
Longitud	309 mm



A14302PLUS

ACEITE

D. Exterior	76.4 mm
Rosca	3/4x16 in
Altura	97 mm



A7533SP

SEPARADOR AGUA
COMBUSTIBLE

D. Exterior	93.7 mm
Rosca	3/4x16 in
Altura	139 mm



AP31071

AIRE CABINA

Altura	29 mm
Ancho	195 mm
Longitud	214 mm

LDD /
LIVIANO
DIÉSEL

ICONOS



VOLKSWAGEN AMAROK 2011-2017 2.0 Diesel

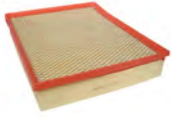

AP35781
AIRE PRIMARIO

Altura	59 mm
Ancho	256 mm
Longitud	312 mm

PP15562
ACEITE

D. Exterior	65.4 mm
D. Interior	18 mm
Altura	104 mm

PFG454
COMBUSTIBLE

D. Exterior	95 mm
D. (E / S)	10 mm / 10 mm
Altura	225 mm

AP31631
AIRE CABINA

Altura	30 mm
Ancho	219 mm
Longitud	278 mm



VOLKSWAGEN CRAFTER 5.0 2011-2021 2.0 Diesel



AP35756
AIRE PRIMARIO

Altura	57.5 mm
Ancho	264 mm
Longitud	349 mm

PP15562
ACEITE

D. Exterior	65.4 mm
D. Interior	18 mm
Altura	104 mm

PFG453
COMBUSTIBLE

D. Exterior	95 mm
D. (E / S)	10 mm / 10 mm
Altura	217 mm

AP31084
AIRE CABINA

Altura	50 mm
Ancho	235 mm
Longitud	350 mm



VOLKSWAGEN TRANSPORTER T5 2009-2015 2.0 LTS



AP35758
AIRE PRIMARIO

Altura	63.5 mm
Ancho	188 mm
Longitud	311 mm

PP15562
ACEITE

D. Exterior	65.4 mm
D. Interior	18 mm
Altura	104 mm

AP31084
AIRE CABINA

Altura	30 mm
Ancho	219 mm
Longitud	278 mm



ES JUSTO

LO QUE NECESITAS

CRUCE DE REFERENCIAS



SOLUCIONES EN FILTRACIÓN
PARA TRANSPORTE MEDIANO

AC DELCO	PARTMO
4267	PMX750R
6126	PFG1105
6132	PM197
6267	PMX750R
6857	A67SP
6940	A777CSP
6940	A777SP
12117	PM17
12132	PM197
12915	A96
12916	A97
12921	A5813SP
12921	A96
12944	A1285DSP
24232	A1480
24897	A9N5570SP
5715388	A1428
19279602	A52041SP
19279605	PP88580
19279606	PM1650
19279607	A4048SP
19279609	A28SP
19279615	PP9452
19279617	A427SP
19279633	A840SP
19279636	AS201SP
19279638	PFG3191102100
19279641	PP28970
19279642	AR90D
19279642	ASR90TSP
19279642	ASV90TSP
19279643	PM9760
19279645	A034L
19279646	A093DSP
19279646	A093SP
19279651	PP7735
19279657	PP201010
19279657	PP201030
19279660	A7533C
19279663	A243004DSP
19279663	A243004DSP
19279673	AP16550
19279675	AP3102
19279677	AP3511
19279679	AP3511
19279688	AP1330
19279695	AP5217
19279697	AP3737
19279698	AP78020
19279703	AP5H100
19279707	APC010
19279711	AP4636
19279714	AP3518SY
19279716	AP2206
19279717	AP203823
19279718	AP2224
19279719	AP2205
19279720	AP17308
19279723	APC23610
19279724	APC23610SY
19279725	APL300
19279727	AP3514

AC DELCO	PARTMO
19279728	AP2884
19279730	AP9S001
19279738	AP3190
19279739	AP323
19279741	APG4800
19279743	AP1087
19279748	AP51250
19279749	AP3537
19279750	AP4439
19279751	AP3513
19279752	AP2021
19279754	AP31820
19279756	AP3557
19279758	AP1312
19315465	AP352660
19315477	AP3554
19315496	AP35793
19315510	AP2877SY
25160561	A1428
25313753	A5813SP
88905886	A113
88905887	A111
88905888	A323
88905889	A14476
88905890	A1406
88905890	A14476
88905891	A111
88905893	AP121
88905897	AP4337
88905898	AP126
88905902	AP3178
88915431	A1R0751SP
94127546	A142SP
95622519	A4011
95627131	AP2712
95627132	AP2877S
95627137	AP16550
95631278	AP2877S
95631281	AP5021
95631282	A4053SP
95631283	A010
95631283	A105SP
95631284	A7602
95631285	A4271SP
95631285	A4271SP
12132W	PM197
1461C	AP3518
1AFBO041	AL106
2PF2157	A7223SP
905C	AP3924
A0115C	AP3191
A1009C	AP2521
A10234C	AP3132
A1030C	AP2291
A1045C	APSL5013Z40A
A1047C	AP2660
A1060C	AP127312
A1063C	AP4129908
A1074C	AP51250
A1075C	AP5021
A1112C	AP31550
A1130C	AP531
A1131C	AP3562

AC DELCO	PARTMO
A1132C	AP16546
A1137C	AP132
A1138C	AP31511
A1140C	AP2680
A1144C	AP603A
A1146C	AP1305
A1147C	AP142
A1163C	AP1339
A1164C	AP3129
A1165C	AP2677
A1166C	AP1323
A1169C	AP2863
A1170C	AP2300
A1174C	AP31511
A1175C	AP2705
A1186C	AP7N1225
A1193C	AP3129
A1199C	AP3124
A1201C	AP3932
A1203C	AP561
A1212C	AP3179
A1220C	AP3179
A1226C	AP35815
A1245C	AP31528
A1245C	AP31555
A124C	AP6261
A1255C	AP31559
A1255C	AP3509
A1256C	AP31544
A1258C	AP1368
A1267C	AP3574
A1279C	AP121
A1280C	AP3574
A1282C	AP3118
A1283C	AP3138
A1286C	AP3135
A1286CK	AP3135
A1287C	AP3137
A1290C	AP3527
A1291C	AP35793
A1300C	AP3707
A1301C	AP3707
A1309C	AP3123
A1316	AP3136
A1316C	AP3136
A1327C	AP3138
A1329C	AP3170
A1347C	AP3133
A1387C	AP2712
A1387C	AP2712A
A1393C	AP2761
A1400C	AP3500
A1413C	AP31531
A1419C	AP3582
A1430C	AP101222K
A1434C	AP127312
A1441C	AP2621
A1461C	AP3518
A1512C	AP1292
A1515C	AP1375
A1517C	AP3515
A1537C	AP2654
A1538C	AP4129907

AC DELCO	PARTMO
A1545C	AP3567
A1548C	AP1323
A1549C	AP31521
A1561C	AP2688
A1604C	AP1365
A1606C	AP2677
A1611C	AP3139
A1616C	AP2677
A164C	AP25867SY
A2011C	AP3133
A2012C	AP3548
A2014C	AP35433
A2036C	AP31628
A2039C	AP3557
A2041C	AP3557
A2044C	AP3128
A2047C	AP3134
A2052C	AP31678
A2056C	AP3121
A207C	AP4M8047
A209C	AP4M9334
A210C	AP4M9378
A2121C	AP2654SY
A2124C	AP821884
A2129C	AP14210
A2130C	AP14220
A2140C	AP3722
A2179C	AP2621
A2192C	AP3936
A2243C	AP1365
A229C	AP101246K
A2602C	AP35591
A2602C	AP35665
A266C	AP4M9335
A267C	AP4M9379
A277C	AP6261
A2849C	AP35606
A290C	AP4M8048
A2932C	AP63680
A2935C	AP3125
A2938C	AP31653
A2955C	AP35755
A2957C	AP35736
A2971C	APSL40A
A297C	AP101275K
A297CL	AP101275K
A299C	AP101246K
A299CL	AP101246K
A301C	AP101234K
A301CL	AP101234K
A302C	AP101222K
A302CL	AP101222K
A3054C	AP3571
A3081C	AP3196
A3083C	AP31942
A3103C	AP31801
A3134C	AP3116
A331C	AP6261
A348C	AP121
A372C	AP3129
A384C	AP25867SY
A394C	APCA502
A3Z40C	AP3111

AC DELCO	PARTMO
A428C	AP110558
A428CL	AP110558
A430C	APCA502SY
A443C	AP106775
A443CL	AP106775
A462C	AP4129908
A462CL	AP4129908
A477C	AP121
A4D000C	AP3122
A505C	AP3709
A509C	AP101234K
A512C	AP101246K
A5203C	AP5203
A534C	AP57MD33
A550C	AP2360
A568C	APSL5013Z40A
A576C	AP101246K
A590C	AP117797
A633C	AP4041
A6362C	AP3932
A639C	AP2425
A65C	A1226LSP
A65C	A33358
A703C	AP101222K
A704C	AP626
A709C	AP46531
A710C	AP46530
A71C	AP3709
A726C	AP117797
A736C	AP147
A738C	AP57MD21
A739C	AP57MD31
A754C	AP2482
A757C	AP4337
A7723C	AP3146
A773C	AP126
A788C	AP137640
A801C	AP626
A821C	AP182028
A825C	AP1861
A826C	AP121
A837C	APCA502SY
A846C	APC203252
A863C	AP2520
A863C	AP2520H
A874C	AP95600906
A886C	AP2576
A887C	AP2576
A887C	AP2577
A888C	AP2489
A889C	AP25867
A890C	AP4000
A905C	AP3924
A910C	AP87658
A942C	AP4416
A9601C	AP3536
A969C	AP812105
A970C	AP114215145
A975C	AP1312
A986C	AP2632
A9959C	AP3513
AB70AC	AP3127
AC114	PM17

AC DELCO	PARTMO
AC119	PM4031840025
AC124	A178PLUS
AC129	PM9885111911
AC156	PM4031840025
AC167	PM4031840025
AC189	PM4031840025
AC195	PM4031840025
AC20	PM813
AC202	PP50361
AC233	PM210
AC32	PM126
AC32B	PM126
AC33	PM126
AC33A	PM126
AC33AB	PM126
AC33B	PM126
AC33C	PM126
AC33D	PM126
AC35A	PM126
AC462C	PM17
AC621	AP4129908
AC72	PM313
AC72A	PM313
AC82	PM313
AC83	PM17
AC91	PM248
AC95	PM3
ACA102	AP62010
ACA108	AP3128
ACA111	AP31528
ACA119	AP2S600
ACA123	AP31628
ACA124	AP31624
ACA135	AP3115
ACA145	AP9S001
ACA150	AP31653
ACA155	APC010
ACA158	AP3196
ACA164	AP3132
ACA165	AP29400
ACA166	AP3144
ACA169	AP3116
ACA171	AP31801
ACA176	AP3191
ACA179	AP3108
ACA180	AP2959
ACA181	AP31788
ACA183	AP31773
ACA187	AP3588
ACA192	AP3537
ACA196	APC301251
ACA209	AP3111
ACA212	AP3117
ACA216	AP3109
ACA218	AP35733
ACA22	AP2761
ACA226	AP31678
ACA230	AP3112
ACA231	AP31697
ACA240	AP35750
ACA241	AP3146
ACA251	AP350990
ACA257	AP31905

AC DELCO	PARTMO
ACA260	AP3107
ACA262	AP3127
ACA265	AP35782
ACA267	AP31899
ACA269	AP35591
ACA273	AP31744
ACA65	AP101222K
ACA86	AP3133
ACA90	AP3567
ACA91	AP1375
ACA95	AP3193
ACC29	AP31060
ACC31	AP31071
ACC41	AP39649
ACC48	AP31739
ACC49	AP71191
ACC58	AP31012
ACC61	AP31060
ACC63	AW5137SP
ACC72	AP31043
ACD000181	A111
ACD000182	A205SP
ACD000183	A58
ACD000184	A14302PLUS
ACD000186	A323
ACD000187	PP6705
ACD000189	AP0978
ACD000190	AP3554
ACD000193	A4053SP
ACD000193	A58
ACD000193	A58PLUS
ACD000193	A58T
ACD000194	A1402
ACD000195	AP3550
ACD129	PM9885111911
ACD159	P346P
ACD173	P346P
ACD185	PM707
ACD185	PM707E
ACD32	PM126
ACD51	P346P
ACD519	P3461
ACD53	PM28S1Z
ACD54	PM324
ACD54	PM324E
ACD54	PM707
ACD54	PM707E
ACD55	PM707
ACD55	PM707E
ACD59	P346P
ACF114	A093SP
ACF12	A52
ACF129	PP7355
ACF134	PFG25121074
ACF140	A7533SP
ACF143	PP28970
ACF145	PFG420
ACF147	PFG391
ACF148	PP22135
ACF156	AS201SP
ACF19	A4886
ACF201	A7533DSP
ACF21	A3726

AC DELCO	PARTMO
ACF35	PFG516K
ACF71	AS1441SP
ACO101	PP31060
ACO103	PP2200C
ACO108	PP85674
ACO110	A243
ACO114	A1480
ACO116	PP4024
ACO118	A4011
ACO124	PP31060
ACO125	PP358
ACO126	A178PLUS
ACO130	PP16328
ACO131	A1406
ACO134	PP62442
ACO139	A58
ACO15	A1SP
ACO22	A14476
ACO29	A20
ACO29	A20PLUS
ACO32	A7029SP
ACO38	A52
ACO40	A2863B
ACO41	A092SP
ACO46	A1406
ACO52	A7041SP
ACO53	A205SP
ACO53	PM28S1Z
ACO56	A7028SP
ACO58	A291
ACO66	A4271SP
ACO75	A113
ACO78	A14478PLUS
ACO82	PP2200
ACO84	A329
ACO89	PP8088
ACO95	A14302PLUS
ACO96	A14302PLUS
AJD20BC	AP35750
BF881	AR17
C111	PM3
C117	PM17
C14	PM3
C159	PM17
C203	PM3
C203X	PM3
C206	PM17
C232	A1480
C235	A7105SP
C267	PMX750R
C267X	PMX750R
C283	AS1040SP
C301	PM3
C315	PM3
C316	PM3
C363	PMX1878100501
C401	PM3
CF177	AP31029
EO20020	PP40425
FF25	PP246
FS1	PFG516K
FS4	PFG516K
FS9002E	PFG3191125000

AC DELCO	PARTMO
FS9129E	PFG25121074
FS9186E	PFG3191125000
GF133	PM210
GF142	PFG516K
GF175	A70010
GF1940	PM1940
GF219	PFG423
GF274	PFG335
GF279	PFG330
GF30	PM210
GF30A	PM210
GF328	PFG368
GF345	PFG7742
GF354	PFG7802
GF355	PFG7742
GF412	PFG516K
GF479	PFG516K
GF4811	PP24811
GF495	PFG1105
GF496	PFG805
GF497	PFG805
GF510	PFG1105
GF513	PFG805
GF516	PFG1104
GF538	PFG1195
GF539	PFG805
GF561	PFG330
GF563	PFG4811
GF600	PFG1104
GF61	PFG516K
GF618	PFG25121074
GF618	PFG330
GF61B	PFG516K
GF633	PFG330
GF634	PFG25121074
GF643	PFG872
GF643B	PFG872
GF65	PFG516K
GF655	PFG423
GF656	PFG423
GF666	PFG44781
GF679	PFG1163
GF694	PFG805
GF709	PFG805
GF710	PFG335
GF712	PFG1105
GF714	PFG44781
GF715	PFG323
GF718	PFG1104
GF729	PFG44781
GF737	PFG0120490B
GF778	PM9885111911
GF782	PFG367
GF783	PFG872
GF798	PFG3191125000
GF803	PFG323
GF815	PFG872
GF816	A4618310
GF818	PFG25121074
GF822	PFG423
GF859	PFG368
GF863	PP7751
GF898	PFG335

AC DELCO	PARTMO
GF91	PF6516K
GF94	PF6516K
GF955	A70010
GS1	PF6516K
H11	A11
HC11	A11
HC11	A12
HC2	A1
HC2	A1SP
K14	PM3
K15	PM3
K17	PM17
L14	PM3
L5	PM3
LT653	PM197
M12	P3461
M16	PM126
P1102	A4052SP
P117	PM17
P203	PM3
P203X	PM3
P204	PM3
P206	PM17
P206F	PM17
P271	PM17
P3	A50
P301	PM210
P320	PM3
P414	PM3
P417	PM17
P940	A777CSP
P940	A777SP
P9600	PM126
PC133K	AP101234K
PC135	AP110558
PC136	AP101246K
PC136K	AP101246K
PC137	AP101222K
PC137K	AP101222K
PC138	AP101275K
PC138K	AP101275K
PC142	APCA502
PC183	APC203252
PC187	AP2291
PC215	AP2291
PC2178E	AP3179
PC2209E	AP4001
PC233	A14302PLUS
PC233	A14302PLUS
PC233	A223
PC247	AR17
PC285	AP3709
PC292	AP1861
PC300	AP626
PC3295E	AP16550
PC334	AP25867
PC335	AP4M8047
PC338	AP4M8048
PC339	AP4M9335
PC343	AP117797
PC399	AP4337
PC515	AP1312
PC556	AP1312

AC DELCO	PARTMO
PC63	APR12
PC70	AP25867SY
PC75	PM197
PF1	A1
PF1	A1SP
PF1030	A343
PF1032	A267
PF1051	A73
PF1051	A73PLUS
PF1052	PM1878100752
PF1054	A134
PF1056	A9N6007SP
PF1070	A339SP
PF1070F	A339SP
PF1071	A427SP
PF1073	PM4031840025
PF1076	PM1878100752
PF1087	A91T1
PF1088	A91T1
PF1088	AR29SP
PF1090	A349SP
PF1097	A91T1
PF1098	AR29SP
PF11	A11
PF1101	A205SP
PF1102	A4052SP
PF11128	A349SP
PF1118	A129SP
PF1127	A1402
PF1127	A1402PLUS
PF1127	A323
PF1127	A4044
PF1127	A52
PF1127	A53PLUS
PF1128	A349SP
PF1177	A4044
PF1177	AR9
PF1195	A142SP
PF1196	A142SP
PF12	A11
PF12	A12
PF1212	A14302PLUS
PF1212	A14302PLUS
PF1212	A223
PF1217	A3000SP
PF1217	A3000SP
PF1218	A1428
PF1218CL	A1428
PF1218FCL	A1428
PF1219	A14476
PF1219	A14476PLUS
PF1220	A1406
PF1220	A14476
PF1222	A73
PF1224	A2863B
PF1224	A2863SP
PF1224	A2863SP
PF1224	A350
PF1224	A4731SP
PF1225	A111
PF1230	A73
PF1232	A113
PF1233	A14476

AC DELCO	PARTMO
PF1233	A14476PLUS
PF1234	A1406
PF1234	A14476
PF1236	A70015SP
PF1237	A58
PF1237	A58PLUS
PF1237	A58T
PF1238	A18
PF1238	A18PLUS
PF1245	A14302PLUS
PF1250	A329
PF1257	A309SP
PF1269	A9080SP
PF1276	A7685SP
PF1298	A4271SP
PF1298	A4271SP
PF132	PM197
PF132W	PM197
PF132X	PM197
PF135	PM197
PF13F	A20
PF13F	A20PLUS
PF14	A267
PF1409	A091AE
PF150	PM197
PF151	PM197
PF157	PM197
PF1595	A350
PF16	A83910
PF163	PM197
PF17	A26SP
PF17	A26SP
PF1703	PP6
PF1707	PP5562
PF1713	PP7196
PF1768	PP4024
PF1803	A267
PF1806	A267
PF1809	A350
PF19	A1
PF19	A1SP
PF1HC	A1
PF1HC	A1SP
PF2	A1
PF2	A1SP
PF20	A20
PF20	A20PLUS
PF2000	A70015SP
PF2004	A70015SP
PF2010	A91T1
PF2021	A91T1
PF2023	AR29SP
PF2025	A70015SP
PF2028	A70015SP
PF2044	A840SP
PF2048	A48SP
PF2051	A354
PF2052	A1406
PF2052	A1406PLUS
PF2053	PP50361
PF2057	A1402
PF2057	A1402PLUS
PF210	PM174

AC DELCO	PARTMO
PF210	PM245
PF2100	A495SP
PF2100F	A495SP
PF2101	A69SP
PF2107	A91480
PF2112	A58
PF2123	A18
PF2123	A18PLUS
PF2132	A20
PF2132	A20PLUS
PF2135	A58
PF2138	A7041SP
PF2138	A205SP
PF2140	AR1218
PF2144	A408SP
PF2146	PP40425
PF2147	A092SP
PF2154	A840SP
PF2157	A7223SP
PF2158	A16242SP
PF2161	A777CSP
PF2161	A777SP
PF2172	PM126
PF2174	A3786SP
PF2174	A3786SP
PF2174F	A3786SP
PF2186	A111
PF2188	PM126
PF2191	A20
PF2191	A20PLUS
PF2192	A4056
PF2192	A52
PF2195	A205SP
PF2196	A343
PF2199	A91T1
PF2199	AR29SP
PF2203	A9N6007SP
PF2206	A447
PF2211	A299E
PF2221	A1406
PF2221	A14476
PF2228	A1406
PF2228	A14476
PF2233E	PP8088
PF2244G	PP8088
PF2253G	PP7196
PF2257G	PP85674
PF2259G	PP8088
PF2261	PP57061
PF23	A33
PF24	A33
PF25	A11
PF25	A12
PF28	A26SP
PF28	A26SP
PF29	A11
PF295	PM9M9740
PF30	A33
PF316	PM210
PF32	A267
PF33	A54SP
PF331	PM192
PF336	PM210

AC DELCO	PARTMO
PF3361	PM210
PF34	A113
PF34	A243
PF344	PM245
PF35	A11
PF351	PM174
PF353	PM192
PF35L	A1428
PF37	A111
PF38	A48SP
PF40	A111
PF40	A9797PLUS
PF400A	A178PLUS
PF41	A14302PLUS
PF41	A18
PF41	A18PLUS
PF42	A1
PF42	A1SP
PF42	AR17
PF432	PM343
PF432L	PM343
PF456G	PP8088
PF457G	PP8088
PF457GO	PP8088
PF458G	PP8088
PF47	A111
PF47	A43S
PF48	A160
PF48	A160PLUS
PF48E	A160
PF48E	A160PLUS
PF51	A4011
PF52	A4011
PF53	A14302PLUS
PF54	A14476
PF54	A4041
PF56	A178PLUS
PF56	A243
PF57	A323
PF58	A1432
PF59	A1432
PF60	A178PLUS
PF61	A1432
PF61E	A1432
PF63	A4051SP
PF67	A3612ASP
PF670	A116SP
PF7	A33
PF712	A54SP
PF7C	A33
PF8	A33
PF813	PM248
PF828	AR29SP
PF832	A84SP
PF856	A299E
PF856L	A299E
PF856TKNG	A48SP
PF857	A67SP
PF859	A1226LSP
PF859	A33358
PF867	A73
PF879	A69SP
PF879L	A69SP

AC DELCO	PARTMO
PF880	A48SP
PF881	AR17
PF893	A116SP
PF897	A9N5570SP
PF898	A54SP
PF899	A116CSP
PF9	A4044
PF902	A97
PF902	A97SP
PF911	A116SP
PF911	A3612ASP
PF911D	A116CSP
PF911DF	A3612ASP
PF911F	A3612ASP
PF911H	A116SP
PF911H	A3612ASP
PF912	A54SP
PF932	A84SP
PF933	A54SP
PF940	A777CSP
PF940	A777SP
PF941	AR29SP
PF947	A010
PF947	A105SP
PF947L	A010
PF947L	A105SP
PF947L	A7041SP
PF967	A73
PF968	PM324
PF968	PM324E
PF970C	A091AE
PF970C	A4046
PF976	A48SP
PF980	A116SP
PF986	PM0011843925
PFL1A	A1
PFL1A	A1SP
PFL400A	A243
PM13	PM197
PM1310	PM197
PM1314	A3612ASP
PM1315	A116SP
PM1315	A3612ASP
PM1316	A9N5570SP
PM132	PM197
PM135	PM197
PM137	PM197
PM138	PM197
PM139	PM197
PM13A	PM197
PM13SERIES	PM197
PM21	PM197
PM22	PM197
PM25	PM197
PM25SERIES	PM197
PM500SERIES	A33
PM700SERIES	A33
PM800	A33
PM800SERIES	A33
PMD13	PM197
PMD21	PM197
PMD22	PM197
PMD25	PM197

AC DELCO	PARTMO
PMD27	PM197
PR	A50
PT1338	A330C
S2	PM17
S75	PMX750R
S751	PMX750R
SA	A14302PLUS
SB	A14302PLUS
SC	A1
SC	A1SP
SC250	PM17
SC259	PM17
SC260	PM17
SD	A113
SD	A18
SD	A18PLUS
SD2	PM17
SD3	A14302PLUS
SD3	A14476
SD3	A223
SE	A14302PLUS
SEF	A113
SF	A14302PLUS
SH	A14302PLUS
SJ	A20
SJ	A20PLUS
SK	A20
SK	A20PLUS
SL	A50
SN	A50
SR	A14302PLUS
ST	A18
ST	A18PLUS
SX	AR17
T1068	A787
T570	PM325
T815	A96
T821	A96
T829	A43SP
T915	A96
T915D	A96
T916	A97
T916D	A97
T92	A96
T921	A5813SP
T921	A96
T93	A97
T936	A96C
T936	A96C
T937	A96C
T937	A96C
T94	A96C
T94	A96C
T944	A1285DSP
T95	A97C
TP1001	A1212SP
TP1001	ASV1212SP
TP1002	A1212SP
TP1003	A1212SP
TP1009	A5813SP
TP1027	AS1003SP
TP1045	PP202030
TP1046	PP246

AC DELCO	PARTMO
TP1057	A5813SP
TP1062	A330C
TP1067	A33358
TP1068	A43SP
TP1069	A1226
TP1069	A1226LSP
TP1119	A4053SP
TP1119	A4054SP
TP1184	PM9885111911
TP1193	A7533DSP
TP1199	A305F
TP1200	A4047
TP1204	PM707
TP1204	PM707E
TP1228	P346P
TP1231	A3627
TP1231	A4053SP
TP1241	A1204SP
TP1241	AS1282SP
TP1241	ASV1282SP
TP1242	AS1282SP
TP1246	A588
TP1246	A588SP
TP1251	A1230
TP1251	AS1230SP
TP1252	A4618310
TP1261	A23
TP1261	A23SP
TP1262	A5813SP
TP1262	AS3202SP
TP1264	A1226LSP
TP1264	A33358
TP1267	A305F
TP1267	A3726
TP1269	A7602
TP1274	A4886
TP1274	A570DSP
TP1274	AK570SP
TP1278	AS1249SP
TP1280	A1345SP
TP1280	AS830SP
TP1285	A7301DSP
TP1285	AS1441SP
TP1292	A1259SP
TP1294	A1226
TP1296	A7653
TP1320	A7301DSP
TP1339	A7656E
TP1340	A7657
TP1349	A7653
TP1390	PP7761
TP1413	A1894
TP1479	AS1040SP
TP1527	AS1003SP
TP1529	AS1272SP
TP567	A15
TP567F	A15
TP574	PM28S1Z
TP619	A15
TP621	P346P
TP623	AR16SP
TP623	AR16SP
TP629	A23

AC DELCO	PARTMO
TP629	A23SP
TP630	A1212SP
TP630	ASV1212SP
TP631	PP246
TP634	A30SP
TP634	A30SP
TP635	A31SP
TP635	A31SP
TP811	A23L39
TP811	A23L39SP
TP815	A96
TP816	A97
TP816	A97SP
TP831	A46SP
TP831	A46SP
TP831	A888
TP858	A33358
TP859	A1226LSP
TP859	A33358
TP860	A1212SP
TP862	A588
TP862	A588SP
TP877	A1P2299
TP877F	A1P2299
TP877F	A1P2299
TP887	A46SP
TP887	A888
TP915	A96
TP915D	A96
TP916	A97
TP916	A97SP
TP916D	A97
TP916D	A97SP
TP916L	A97
TP916L	A97SP
TP920	A85
TP920F	A614
TP927	A150F
TP927	A150F
TP928	A97C
TP928L	A97C
TP931	A46SP
TP931	A588
TP931	A588SP
TP934	A30SP
TP934	A30SP
TP935	A31SP
TP935	A31SP
TP936	A96C
TP936	A96C
TP943	A243004
TP943	A243004SP
TP944	A1285DSP
TP961	A243004
TP961	A33358
TP972	A23L39
TP972	A23L39SP
TP985	PP204030
TP992	A330C
TP992	A941C
TP992	A941SP
TP994	A588
TP994	A588SP

AC DELCO	PARTMO
TP995	PP201010
TP995	PP201030
UPF52	A4011
WF100	AW5137SP
WF101	AW2010SP
WF102	AW2016SP
WF103	AW2010SP
WF104	AW2016SP
WF109	AW2022SP
WF111	AW2022SP
WF112	AW5137SP
WF113	AW5137SP
WF114	AW2010SP
WF115	AW2016SP
WF115F	AW2016SP
WF12	AW475SP
WF4	AW5137SP
X100	A1
X101	A091AE
X104	A4044
X105	A4044
X107	A091AE
X108	A091AE
X11	A1
X114	A178PLUS
X116	A14302PLUS
X117	A113
X119	A323
X12	A54SP
X120	A73
X121	A4044
X123	A20
X123	A20PLUS
X123	AR1218
X124	A14302PLUS
X128	A339SP
X130	A111
X14	A1
X14	A1SP
X15	A18
X15	A18PLUS
X17	AR17
X18	A14476
X18	A18
X18	A18PLUS
X18BL	A20
X18BL	A20PLUS
X18BL	AR1218
X20	A14476
X20	A18
X20	A18PLUS
X21	A178PLUS
X22	A840SP
X28	A4011
X29	A1
X35	A7028SP
X36	A22SP
X38	A267
X39	A349SP
X45	A323
X46	A73
X49	A7028SP
X50	A267

AC DELCO	PARTMO
X502	A20
X502	A20PLUS
X502	AR1218
X504	A178PLUS
X513	A178PLUS
X56	A73
X68	PM324
X68	PM324E
X69	A349SP
X71	A178PLUS
X72	A14476
X88	A4044
X9	A178PLUS
X9	A18
X9	A18PLUS
X93	A111
X95	A4044
XD25	A243004
XD25	A33358
XD33	A4618310
XD63	A1226LSP
XD67	A1226LSP
XD67	A33358
XD77	A1226LSP
XD77	A33358
XD79	A4886
BALDWIN	PARTMO
B1	A1
B105	A010
B105	A105SP
B109	A2863B
B109	A2863SP
B113	A113
B121	A50
B129	A129SP
B131	A113
B131	A14476
B131	A4041
B134	A134
B1400	A58
B1400	A58PLUS
B1400	A58T
B1402	A1402
B1402	A1402PLUS
B1403	A1403SP
B1404	A4044
B1405	A14302PLUS
B1406	A1406
B1406	A1406PLUS
B1406	A14476
B1407	A14302PLUS
B141	A4044
B1413	A14302PLUS
B1416	A1406
B1416	A14476
B1421	A323
B1425	A323
B1425	A323PLUS
B1428	A1428
B143	A113
B1430	A14302PLUS
B1432	A1432
B1446	A2863B

BALDWIN	PARTMO
B145	A243
B159	A14302PLUS
B159	A14302PLUS
B159	A223
B160	A160
B160	A160PLUS
B161	A73
B161S	A73
B161S	A73PLUS
B166	AR9
B167	A48SP
B168	A73
B168	A73PLUS
B173	A4044
B173S	A4044
B173S	AR9
B178	A178PLUS
B179	A323
B196	A116CSP
B197	A243
B199	A73
B2	A1
B2	A1SP
B201S	A4052SP
B202	A091AE
B202	A4046
B205	A205SP
B211	A350
B222	A494E
B227	A323
B227	A323PLUS
B227	A52
B228	A18
B228	A18PLUS
B229	A20
B232	A20
B232	A20PLUS
B233	A20
B233	A20PLUS
B236	A840SP
B243	A243
B243	A243
B245	A4044
B245	AR4M
B246	A1
B247	A73
B249	A1
B253	A1
B254	A50
B27	A11
B27	A12
B280	A33
B295	A113
B298	A14302PLUS
B299	A299E
B301	A323
B301	A323PLUS
B301	A52
B309	A309SP
B329	A329
B33	A14476
B33	A14476PLUS
B34	A20

BALDWIN	PARTMO
B34	A20PLUS
B34	AR1218
B35	A4011
B35S	A4011
B37	A1406
B37	A14476
B38	A111
B39	A33
B40051	PP17356
B40053	A40053SP
B404	A010
B404	A105SP
B43	A111
B43S	A111
B43S	A43S
B447	A447
B45	A9003SP
B481	A267
B488	A323
B49	A69SP
B494	A494E
B494	A50
B495	A495SP
B495MPG	A495SP
B495SS	A495SP
B50	A50
B5087	AW2127SP
B5089	AW5137SP
B5134	AW2010SP
B5134	AW2010SP
B5177	AW2022SP
B6	A11
B6	A1428
B605	A9N6007SP
B608	A323
B6HPG	A11
B6HPG	A1428
B7	A84SP
B7004	A205SP
B7005	A205SP
B7006	A2863B
B7006	A2863B
B7010	A1432
B7018	A7018
B7020	A243
B7030	A408SP
B7032	A4048SP
B7033	A4051SP
B7034	A4049SP
B7039	A3786SP
B7042	A091AE
B7045	A1480
B7089	A840SP
B7099	A7028SP
B7108	A205SP
B7109	A350
B7117	A427SP
B7121	A7028SP
B7121	A7121SP
B7125	A7125
B7125	A7125
B7128	A7028SP
B7130	A4048SP

BALDWIN	PARTMO
B7143	A840SP
B7144	A7144SP
B7155	A7105SP
B7167	A4056
B7174MPG	A7174SP
B7177	A7177SP
B7179	A7133
B7189	A2863B
B7189	A350
B7215	A48SP
B7216	A323
B7220	A16242SP
B7223	A7223SP
B7243	A52
B7243	A53PLUS
B7273	A2863SP
B7273	A350
B7275	A14302PLUS
B7276	A3603
B7276	A3603PLUS
B7285	A58
B7290	A178PLUS
B7306	A7306SP
B7327	A7898SP
B7334	A323
B7352	A4044
B7361	A14302PLUS
B7372	A339SP
B7375	A7375SP
B7383	A7383SP
B7396	A116SP
B7396	A3612ASP
B7407	A323
B7409	A7685SP
B7422	A160PLUS
B7422	A160PLUS
B7431	A20
B7432	A4044
B7441	A1402
B7443	A160
B7443	A160PLUS
B7444	A52041SP
B7446	A111
B7449	A52041SP
B7451	A812
B7452	A15403
B7467	AR17
B7469	A091AE
B7483	A7223SP
B7487	A323
B7491	A14302PLUS
B75	A9N6007SP
B7503	A7503SP
B7506	A7506SP
B7507	A69SP
B7552	A292
B7575	A777CSP
B7575	A777SP
B7577	A777CSP
B7577	A777SP
B7577B	A777CSP
B7577B	A777SP
B7585	A350

BALDWIN	PARTMO
B76	A67SP
B7600	A67SP
B7685	A7685SP
B76B	A67SP
B76SS	A67SP
B7700	A67SP
B8	A11
B95	A116SP
B95	A3612ASP
B95B	A116SP
B95B	A3612ASP
B95HPG	A116SP
B95MPG	A116SP
B95SS	A116SP
B96	A116SP
B9601	A840SP
B96B	A116SP
B96B	A3612ASP
B96HPG	A116SP
B96MPG	A116SP
B96SS	A116SP
B975	A48SP
B99	A69SP
B99B	A69SP
B99HPG	A69SP
B99MPG	A69SP
B99SS	A69SP
BA5374	AA5374
BD103	A3000SP
BD103	A3000SP
BD103SS	A3000SP
BD1403	A1403SP
BD142	A142SP
BD232	A232SP
BD28	A092SP
BD28	A28SP
BD325	A325SP
BD50000	A9080SP
BD7028	A7028SP
BD7029	A7029SP
BD7029	A7029SP
BD7029	A7029SP
BD7029	A7029SP
BD7041	A7041SP
BD7095	A7095
BD7105	A7105SP
BD7105	A7105SP
BD7141	A205SP
BD7153	A9080SP
BD7154	A9080SP
BD7158	A7158SP
BD7159	A2700SP
BD7159	A2700SP
BD7160	A4271SP
BD7160	A4271SP
BD7166	A7041SP
BD7166	A205SP
BD7169	A2700SP
BD7169	A2700SP
BD7169	A2700SP
BD7250	A9025SP
BD7252	A9035SP
BD7309	A3000SP
BD7309	A3000SP
BD7325	A7105SP

BALDWIN	PARTMO
BD7355	A9080SP
BD7509	A9080SP
BE5135	AW5137SP
BE5177	AW2022SP
BF1010	PF6335
BF1049	PF61104
BF1104	PF61104
BF1105	PF61105
BF1138	PF644781
BF1148	PF6423
BF1150	PF644781
BF1162	PF60120490B
BF1163	PF61163
BF1166	PF6872
BF1173	PF6323
BF1185	PF625121074
BF1186	PF64811
BF1191	PF61191
BF1195	PF61195
BF1202	A787
BF1204	A1204SP
BF1204O	AS4057SP
BF1204SP	A1204SP
BF1205	A1204SP
BF1205	A1205SP
BF1205SP	A1204SP
BF1205SP	A7301DSP
BF1212	A1212SP
BF1212	ASV1212SP
BF1212HP	A1212SP
BF1212W	A1212SP
BF1213	A5813SP
BF1214	A1212SP
BF1220	A1212SP
BF1221	A1226
BF1221	A243004DSP
BF1221	A243004DSP
BF1222	A1230
BF1222	A7301DSP
BF1222O	A1230
BF1222SP	A1230
BF1222SP	A7301DSP
BF1222SP	AS1230SP
BF1223	A7301DSP
BF1223O	AS1441SP
BF1223SP	A7301DSP
BF1224	A830
BF1225	A1212SP
BF1226	A1226
BF1229	A1230
BF1229	A7301DSP
BF1230	A1230
BF1230	A7301DSP
BF1231	A7301DSP
BF1249	A1259SP
BF1249	AS1249SP
BF1249O	AS1249SP
BF1252	A1212SP
BF1257	A11213DSP
BF1259	A1259SP
BF1263SP	AS1272SP
BF1264SP	AS1040SP
BF1266	A1285DSP

BALDWIN	PARTMO
BF1272SP	AS1272SP
BF1274SP	AS1040SP
BF1274SPS	AS1040SP
BF1277SP	AS1040SP
BF1277SPS	AS1040SP
BF1280	A787
BF1280	A787
BF1280O	ASV1282SP
BF1282	AS1282SP
BF1282O	AS1282SP
BF1293SPS	AS1003SP
BF1294O	AR90D
BF1294O	ASR90TSP
BF13	A034L
BF13	A4053SP
BF13	A5138SP
BF1323	A1212SP
BF1324	A1212SP
BF1342	AS3202SP
BF1343	A1212SP
BF1344	A1212SP
BF1345	A1345SP
BF1345O	A1345SP
BF1345O	AS830SP
BF1346O	AS5850SP
BF1346SP	AS5850SP
BF1347	A7301DSP
BF1349	AR90D
BF1349	ASR90TSP
BF1358O	AS27177JSP
BF1366	AS4654SP
BF1366O	AS4654SP
BF1367	A1226LSP
BF1378SPS	AS1003SP
BF1383O	AS88583SP
BF1384SP	AS4654SP
BF1386O	AS24030SP
BF1387O	AS11001SP
BF1390O	AR90D
BF1390O	ASR90TSP
BF1390O	ASV90TSP
BF1391O	AS46018SP
BF330	A330C
BF46016O	AS1441SP
BF46026O	A1204SP
BF46032	A7653
BF46034	A8059
BF46071	ASV1060SP
BF46083O	ASR90TSP
BF46085	A830
BF46098O	AS5850SP
BF46100O	AS5850SP
BF46104	A7813SP
BF5587D	A1226LSP
BF577	A23L39
BF580	A96
BF580O	A96
BF580OB	A96
BF5801	A23
BF580B	A96
BF581	A97
BF581O	A97
BF581O	A97SP

BALDWIN	PARTMO
BF5810B	A97
BF5812	A1212SP
BF5813	A5813SP
BF581B	A97
BF584	A85
BF584B	A85
BF586	A1226LSP
BF586D	A1226LSP
BF587	A1226LSP
BF587	A33358
BF587	A33358L
BF587B	A1226LSP
BF587D	A1226LSP
BF588	A588
BF588	A588SP
BF592	A96C
BF593	A97C
BF594	A4053SP
BF614	A614
BF707	PM707
BF707	PM707E
BF719	A7602
BF720	A3726
BF7524	A33358
BF7525	A1P2299
BF7525	A1P2299
BF7528	A305F
BF7529	A23
BF7530MPG	A1R0751SP
BF7532	A7533SP
BF7533	A7533DSP
BF7533	A7533SP
BF7534	A4886
BF7534	A570DSP
BF7534	AK570SP
BF7535	A7533DSP
BF7535	A7533SP
BF7537	P596
BF7539	A7653
BF7541	A4053SP
BF7552	A292
BF7557	A23
BF7557B	A23
BF7558	A1212SP
BF7559	A7602
BF7584	A588
BF7586	A70015SP
BF7601	A4053SP
BF7602	A7602
BF7606	A48MC
BF7612	A97
BF7613	A97
BF7614	A7614SP
BF7623	A91T1
BF7623	A70020SP
BF7624	A1894
BF7629	A588SP
BF7632	A1R0751SP
BF7633	A1P2299
BF7633	A1P2299
BF7634	A1R0751SP
BF7640	A97
BF7644	A7653

BALDWIN	PARTMO
BF7645	A70015SP
BF7648	A4054SP
BF7653	A7653
BF7656	A7656E
BF7657	A7657
BF7660	PF61163
BF7666	A4053SP
BF7683	A4047
BF7689	A33358
BF7696	A7656E
BF7725	PF6516K
BF7736	PF6516K
BF7742	PF67742
BF7750	A70010
BF7752	A1226LSP
BF7753	A7753SP
BF7766	A7766SP
BF7773	A7773SP
BF7784D	AS7784D
BF7802	PF67802
BF781	A1285DSP
BF7813	A7813SP
BF7814	A8059
BF783	A4618310
BF7838	A093DSP
BF7838	A093SP
BF7841	A4053SP
BF785MPG	A111
BF786	A588C
BF787	A787
BF788	A33358
BF789	A305F
BF789	A3726
BF789010	PP202030
BF7892	A330C
BF7908	A1894
BF7911	A30SP
BF7911	A30SP
BF792	A292
BF792	A305F
BF792	A3726
BF792	A3726SP
BF7921	A1226
BF7922	A7813SP
BF7923	A1P2299
BF7923	A1P2299
BF7927	A7927SP
BF7929 KIT	A7929SPKIT
BF7931	A243004
BF7932	A7932SP
BF7940	A7813SP
BF7943	A8059
BF7957	A7813SP
BF7958	PF67958
BF7960	PF6872
BF7962	PF6367
BF7966	A7813SP
BF7967	A4053SP
BF7970	AS200SP
BF7976	AS200SP
BF798	A56670
BF7985	A787
BF7993	A56670

BALDWIN	PARTMO
BF7995	A70015SP
BF7997	A7653
BF7998	A1226ISP
BF805	PF6805
BF825	P346P
BF836	PF6323
BF840	PF6516K
BF840K1	PF6516K
BF876	A30SP
BF876	A30SP
BF876B	A30SP
BF876B	A30SP
BF876K	A30SP
BF876K	A30SP
BF877	A31SP
BF877	A31SP
BF877B	A31SP
BF877B	A31SP
BF877K	A31SP
BF877K	A31SP
BF881	PF6516K
BF884	P3461
BF884	P3461
BF888	A46SP
BF888	A46SP
BF888	A888
BF891	A1212SP
BF892	A1212SP
BF8921	AS103SP
BF896	A43SP
BF915	A915
BF932	PF6516K
BF940	A4047
BF941	A330C
BF941	A941C
BF941	A941SP
BF948	A15
BF948B	A15
BF948D	A15
BF948JD	AR16SP
BF954	A4053SP
BF955	A70010
BF957	A23
BF957	A23SP
BF957B	A23
BF957D	A1212SP
BF957D	ASV1212SP
BF966	PF61105
BF970	A1P2299
BF970	A1P2299
BF971	A48MC
BF976	A150F
BF976	A150F
BF976B	A150F
BF979	A23L39
BF979	A23L39SP
BF9818	A7301DSP
BF9819	A243004
BF9821	AS103SP
BF98710	AR90D
BF98710	ASR90TSP
BF9877	A7602
BF988	A243004

BALDWIN	PARTMO
BF988	A243004SP
BF988	A33358
BF9887	A292
BF9894	A9894DSP
BF9904	A1CSP
BF99120	ASR45SP
BF9920	AS1040SP
BF993	A243004
BK6185	A7656E
BK6266	A614
BK6269	A614
BK6271	A1259SP
BK6300	A3612ASP
BK6310	A3612ASP
BK6311	A3612ASP
BK6312	A3612ASP
BK6316	A15
BK6316	A3612ASP
BK6317	A3612ASP
BK6318	A3612ASP
BK6321	A3612ASP
BK6350	A3612ASP
BK6413	A3612ASP
BK6418	A1226
BK6419	A3612ASP
BK6420	A15
BK6420	A3612ASP
BK6423	A3612ASP
BK6430	A3612ASP
BK6431	A3612ASP
BK6432	A3612ASP
BK6433	A3612ASP
BK6435	A3612ASP
BK6439	A3612ASP
BK6440	A7766SP
BK6440	A9080SP
BK6464	A7766SP
BK6464	A9080SP
BK6485	A1226
BK6504	A3612ASP
BK6509	A3612ASP
BK6511	A3612ASP
BK6523	A3612ASP
BK6526	A3612ASP
BK6537	A3612ASP
BK6547	A3612ASP
BK6553	A3612ASP
BK6556	A495SP
BK6558	A495SP
BK6561	A495SP
BK6580	A1428
BK6588	A3612ASP
BK6592	A495SP
BK6613	A7656E
BK6613	A7657
BK6658	A7657
BK6659	A7657
BK6660	A7685SP
BK6663	A7685SP
BK6665	A7656E
BK6671	PP7761
BK6674	A7656E
BK6674	A7657

BALDWIN	PARTMO
BK6675	PP7761
BK6676	PP7761
BK6693	A7656E
BK6693	A7657
BK6808	A1428
BK6810	A7301DSP
BK6810	AS1441SP
BK6832	AS1282SP
BP792	A305F
BP792	A3726
BT111	A1
BT136	A11
BT136	A1428
BT216	A1SP
BT217	AR17
BT223	A14302PLUS
BT223	A14302PLUS
BT223	A223
BT230	A9N5570SP
BT23611	A54SP
BT237	AR17
BT238	A267
BT251	AR17
BT259	A26SP
BT259	A26SP
BT261	A299E
BT266	A1
BT267	A267
BT274	A54SP
BT287	AR29SP
BT28710	A91T1
BT28710	AR29SP
BT310	A73
BT338	A291
BT339	A339SP
BT342	A48SP
BT343	A343
BT347	A22SP
BT348	A267
BT349	A349SP
BT353	A113
BT354	A354
BT364	A54SP
BT37110	A70015SP
BT371MPG	A70015SP
BT387	AR29SP
BT38710	A91T1
BT388	A91T1
BT38810	A91T1
BT389	A91T1
BT402	A7223SP
BT427	A427SP
BT452	A54SP
BT470	A9N6007SP
BT523	A69SP
BT524	A1
BT536	A16242SP
BT7237	A7898SP
BT7237MPG	A7898SP
BT7316	A267
BT7339	A339SP
BT7349	A339SP
BT8302	A349SP

BALDWIN	PARTMO
BT8357	A4863
BT83910	A83910
BT8409	A14302PLUS
BT8433	A840SP
BT8434	A1
BT8434	A1SP
BT8504	A354
BT9346MPG	A70015SP
BT9356	A91T1
BT9465	A83910
BT958	A83910
BW1534	AW5137SP
BW5072	AW2010SP
BW5133	AW2010SP
BW5134	AW5137SP
BW5135	AW5137SP
BW5136	AW5137SP
BW5137	AW5137SP
BW5138	AW2010SP
BW5139	AW2010SP
BW5140	AW2016SP
BW5141	AW2237SP
BW5176	AW475SP
BW5177	AW2022SP
BW5178	AW475SP
BW5179	AW2022SP
BW5182	AW2010SP
BW5183	AW2237SP
BW5234	AW5137SP
C184P	PM245
C201K	PM17
C40F	PM3
C41	PM3
C42F	PM17
C52MS	PM17
C64P	PM210
C703L	PF6516K
C705L	PMX1878100501
C73P	PM210
C73PS	PM210
C750E	PMX750R
C750EP	PMX750R
C750L	PMX750R
C78P	PM1878100270
C80P	PM174
C81P	PM210
C84P2	PM210
CA10293	AP35815
CU406	A1480
CU4068	A1480
DL2	A1
F834F	PM324
F834F	PM324E
F878F	PM28S1Z
F950F	PM28S1Z
F950F	PM325
F953F	PM324
F953F	PM324E
F953F	PM707
F953F	PM707E
LL1615	AP4M8047
LL1634	AP4M9334
LL1636FN	AP101234K

BALDWIN	PARTMO
LL2438	AP57MD21
LL2439	AP57MD31
LL2482	AP2482
LL2503	AP95600906
LL2520	AP2520
LL2557	AP7N1225
LL2582	AP2216
LL2596	AP2576
P1419	PP40425
P1439	PP8088
P1443	PP7181
P1445	PP8088
P170	PM126
P171	PM126
P174	PM126
P184	PM245
P20HD	PM197
P20HDE	PM197
P294	PM4031840025
P40	PM3
P40010	PP6013Z
P40011	PM1878100270
P40021	PP88580
P40074	PP80215
P406	A1480
P406	A243
P42	PM17
P507	PM0011843925
P5092	PP5092
P52	PM17
P524	PM4031840025
P64	PM210
P7053	PM1650
P7092	PM53103E
P7093	PM54236E
P7118	PP9452
P7138	PP27908
P7188	PP9452
P7192	PP12140
P7196	PP7196
P7199	PP7199
P723	PM1878100752
P7230	PP7230SP
P73	PM210
P7308	PP5562
P7313	PP6
P7364	PP3C30A
P7365	PM2200
P7365	PP2200
P7399	PP7399
P7400	PP57061
P7406	PP7406
P7415	PP15466
P7415	PP4780
P7418	PP31060
P7423	PP7199
P7438	PP1053
P7442	PP8088
P7450	PP358
P7454	PP4024
P7455	PP72321
P7489	PP85674
P7492	PP79744

BALDWIN	PARTMO
P7493	PP71811
P7494	PP7494
P7505	PP7505
P7508	PP7508
P7615	PP50361
P80	PM174
P80HD	PM174
P81	PM210
P82	PM192
P82HD	PM192
P842	PM210
P998	PM248
P999	PM343
P999HD	PM343
PA10000	AP31950
PA10025	AP31899
PA10034	AP31631
PA10044	AP31980
PA10081	AP31043
PA10091	AP99727
PA10106	AP311020
PA10108	AP31138
PA10411	AP43100
PA1615	AP4M8047
PA1634	AP4M9334
PA1634XP	AP4M9334
PA1636FN	AP101234K
PA1647	AP4M8048
PA1656	AP4041
PA1667FN	AP101222K
PA167	AP1861
PA1673	AP4M9378
PA1674	AP4M9379
PA1675	AP4M9335
PA1681FN	AP101246K
PA1690FN	AP101275K
PA1708FN	AP101222K
PA1802	AP3129
PA1814	AP4M9378
PA1846	APCA502
PA1846XP	APCA502
PA1862	AP110558
PA1880	APCA502SY
PA1882	AP101246K
PA1882FN	AP101246K
PA1884XP	AP4129908
PA1885	AP110558
PA1893	AP106775
PA1911	AP4129908
PA1998	AP25867SY
PA2007	AP6261
PA2008	AP121
PA2014	AP25867SY
PA2041	AP3129
PA2042	AP1861
PA2054	APR9
PA2075	AP626
PA2077	AP147
PA2090	AP4337
PA2099	APR12
PA2106	AP126
PA2113	AP121
PA2125	AP25867SY

BALDWIN	PARTMO
PA2130	AP323
PA2134	AP3924
PA2135	AP1312
PA2140	AP4041
PA2150	AP3562
PA2163	AP1323
PA2164	AP1305
PA2169	AP31550
PA2171	AP3179
PA2180	AP603A
PA2184	AP146
PA2190	AP132
PA2194	AP3932
PA2201	AP1330
PA2202	AP531
PA2207	AP3124
PA2209	AP3142
PA2214	AP3568
PA2215	AP142
PA2216	AP561
PA2219	AP3179
PA2220	AP31559
PA2220	AP3509
PA2237	AP35793
PA2243	AP3133
PA2246	AP31531
PA2257	AP1339
PA2312	AP117797
PA2317	AP57MD33
PA2320FN	APSL5013Z40A
PA2360FN	AP2360
PA2405	APC203252
PA2425	AP2425
PA2426FN	AP25867
PA2427	AP87658
PA2431	AP46530
PA2432	AP46531
PA2438	AP57MD21
PA2439	AP57MD31
PA2469	AP25867SY
PA2475	AP2291
PA2482	AP2482
PA2488FN	AP4000
PA2489	AP2489
PA2503	AP95600906
PA2504	AP812105
PA2520	AP2520
PA2520	AP2520H
PA2521	AP182028
PA2522	AP137640
PA2536	AP16546
PA2545	AP114215145
PA2557	AP7N1225
PA2577	AP5021
PA2578	AP51250
PA2582	AP2216
PA2583	AP4416
PA2586	AP2521
PA2594	AP4M9378
PA2596	AP2576
PA2599	AP2576
PA2599	AP2577
PA2621	AP2621

BALDWIN	PARTMO
PA2632	AP2632
PA2657FN	AP101222K
PA2660	AP2660
PA2669FN	APSL5013Z40A
PA2676	AP127312
PA2676XP	AP127312
PA2677	AP2677
PA2680	AP2680
PA2688	AP2688
PA2705	AP2705
PA2708	AP127313
PA2712	AP2712
PA2712	AP2712A
PA2736	AP4M8048
PA2737	AP4M9335
PA2741	AP2741
PA2761	AP2761
PA2767	APG4800
PA2779	AP812105
PA2780	AP95600906
PA2788	AP4129907
PA2797	AP524344
PA2805	AP2805
PA2814	AP4091
PA2835	APC203252SY
PA2836	AP41702SY
PA2850	AP95600906
PA2855	AP3138
PA2863	AP2863
PA2877F	AP101246K
PA2877FN	AP101246K
PA2881	AP35553
PA2884	AP2884
PA2904	AP2825
PA2913	AP3600
PA3400	AP3138
PA3411FN	AP3193
PA3467	AP2741
PA3629	AP4129907
PA3630FN	AP87657
PA3631	AP87658
PA3657	AP561
PA3660FN	AP3500
PA3674	AP2489
PA3689	AP51250
PA3761FN	AP4000
PA3791FN	AP101222K
PA3801FN	AP101222K
PA3838	AP3838
PA3916	AP127312
PA3938	AP2216
PA3961	AP1908233
PA3989FN	AP101246K
PA4015	AP3138
PA4016	AP311002
PA4016	AP3118
PA4019	AP2300
PA4023	AP31511
PA4026	AP3119
PA4028	AP3135
PA4031	AP3123
PA4034	AP31555
PA4043	AP1375

BALDWIN	PARTMO
PA4046	AP3574
PA4047	AP35645
PA4048	AP35644
PA4050	AP3137
PA4058	AP16546
PA4060	AP3136
PA4068	AP31564
PA4070	AP31544
PA4071	AP6261
PA4072	AP186
PA4075	AP3515
PA4078	AP3178
PA4081	AP3170
PA4082	AP3527
PA4083	AP3170
PA4084	AP31521
PA4092	AP1323
PA4099	AP1292
PA4102	AP1365
PA4103	AP3128
PA4104	AP3139
PA4105	AP3176
PA4111	AP35591
PA4111	AP35665
PA4122	AP3557
PA4124	AP3581
PA4125	AP3582
PA4127	AP3134
PA4138	AP3567
PA4147	AP35736
PA4160	AP1365
PA4163	AP3557
PA4165	AP3116
PA4167	AP35755
PA4180	AP31628
PA4185	AP35602
PA4305	AP31653
PA4307	AP3125
PA4308	AP3565
PA4309	AP31588
PA4310	AP3140
PA4313	AP35790
PA4316	AP3571
PA4322	AP31753
PA4327	AP31071
PA4341	AP3112
PA4344	AP3196
PA4348	AP3108
PA4353	AP3121
PA4360	AP31834
PA4362	AP35741
PA4363	AP29400
PA4373	AP31033
PA4376	APSL40A
PA4390	AP3570
PA4391	AP31739
PA4393	AP31071
PA4393	AP31081
PA4397	AP3191
PA4398	AP31029
PA4400	AP35961
PA4401	AP3144
PA4402	AP31697

BALDWIN	PARTMO
PA4404	AP31043
PA4409	AP31035
PA4410KIT	AP31060
PA4413	AP3122
PA4418	AP31942
PA4421	AP3117
PA4436	AP35783
PA4437	AP31795
PA4438	AP35898
PA4442	AP3132
PA4446	AP31801
PA4455	AP35844
PA4469	AP31461
PA4469	AP31461
PA4471	AP31992
PA4472	AP31874
PA4481	AP31900
PA4489	AP31035
PA4583FN	AP101222K
PA4585	AP2705
PA4601	AP3570
PA4645FN	AP101275K
PA4648	AP67030
PA4649	AP54180
PA4785	AP3517
PA4789	AP6293
PA4857	AP31037
PA4985	AP43042
PA5274	AP12020
PA5275	AP12020SY
PA5359	AP31036
PA5410FN	AP101275K
PA5525	AP4091
PA640	AP3709
PA646	AP6261
PA8036	AP3838
PF10	PP246
PF10	PP246
PF231	PM28S1Z
PF311	PM988511911
PF332	PM1878100270
PF332	PM1878100271
PF46088	PP7355
PF46094	PM19765SP
PF46135	PP46135
PF46235	PP46235SP
PF466	PM707
PF466	PM707E
PF589	PP204030
PF58910	PP204030
PF58930	PP204030
PF589E	PP204030
PF590	PP202030
PF59010	PP202030
PF59030	PP202030
PF598	PP201010
PF598	PP201030
PF59810	PP201010
PF59810	PP201030
PF59830	PP201010
PF7548	PM7680
PF7610	PP7751
PF7620	PM7680

BALDWIN	PARTMO
PF7621	PM7680
PF7651	PP7751
PF7661	PP7761
PF7680	PM7680
PF7735	PP7735
PF7744	PM7680
PF7748	PM19624SP
PF7751	PP7751
PF7761	PP7761
PF7773	A7773SP
PF7777	PP7777SP
PF7779	PP19684SP
PF7779	PP7779
PF7782	PM19728SP
PF7789	PP204030
PF7790	PP202030
PF7889	PP204030
PF788910	PP204030
PF788930	PP204030
PF7890	PP202030
PF789010	PP202030
PF789030	PP202030
PF7895	PM19624SP
PF7910	PM324
PF7910	PM324E
PF7930	PM19765SP
PF7978	PP7978
PF7986	PP7986
PF822	PM192
PF834	PM707
PF834	PM707E
PF860	PM210
PF882	PP246
PF899	PM9760
PF940	A777CSP
PF940	A777SP
PF950	PM28S1Z
PF963	PM28S1Z
PF9803	PP22135
PF9838	PP201010
PF9890	PM1940
PF9897	PM1940
PF9908KIT	PP9908KIT
PF9914KIT	PP9914KIT
PF9919	PP28970
PF9924KIT	PP9924KIT
PF9983	PP7761
PR59030E	PP202030
PT108	PM813
PT108HD	PM813
PT12	PM313
PT153	PM1878100752
PT157	PM174
PT159	PM197
PT159E	PM197
PT189	PM9M9740
PT189MPG	PM9M9740
PT243	PM192
PT269	PM245
PT294	PM4031840025
PT385	PM197
PT390MPG	PM64904
PT391MPG	PM64906

BALDWIN	PARTMO
PT466	PM9885132652
PT82HD	PM192
RS10035	APC010
RS2863	AP2863
RS2994	APC23610
RS30238	AP17871
RS30242	AP3543
RS3291	AP3921
RS3501	AP3501
RS3517	AP2690
RS3518	AP3518
RS3518XP	AP3518
RS3518XP	AP3518
RS3519	AP3518SY
RS3525	AP14220
RS3530	AP2654
RS3531	AP2654SY
RS3535	AP14220
RS3538	AP14210
RS3539	AP3539
RS3541	AP821884
RS3542	AP3542
RS3543	AP3543
RS3544	AP3544P
RS3545	AP3545
RS3548	AP3548
RS3702	AP3988
RS3706	AP3707
RS3707	AP3707
RS3710	AP17845
RS3711	AP17846
RS3716	AP3716
RS3722	AP3722
RS3733	AP3736
RS3736	AP3736
RS3737	AP3737
RS3870	AP3870
RS3871	AP3870SY
RS3920	AP3920
RS3921	AP3921
RS3936	AP3936
RS3940	AP10903
RS3988	AP3988
RS3992	APC20500
RS3993	APC20500SY
RS3994	APC23610
RS3995	APC23610SY
RS4161	AP35433
RS4189	AP63680
RS4445	AP23603
RS4450	AP35893
RS4584	AP3936
RS4595	AP3988
RS4634	AP3936
RS4636	AP4636
RS4637	AP4637
RS4642	AP4642
RS4806	AP7242
RS4807	AP7242
RS4862	AP4862
RS4863	AP4863
RS4959	AP4959
RS4966	AP49064

BALDWIN	PARTMO
RS4967	AP9961
RS4971	AP4971
RS4989	AP4989
RS5288XP	AP4986
RS5342	AP25653
RS5342	AP25653
RS5358	AP84457
RS5361	AP4971SY
RS5408	AP49064SY
RS5434	AP2877S
RS5538	AP5538
RS5539	AP5538SY
RS5543	AP3542
RS5544	AP3543
RS5549	AP84457SY
RS5627	AP5627
RS5628	AP5628
RS5632	AP9961
RS5670	AP3270
RS5776	AP9961
RS5782	AP80006
RS5782	KITAP80006 / AP80006SY
RS5783	AP80006SY
T103W	PM17
T73P	PM210
V1040C	AS1040SP
V1F	A1
V233F	A20
V233F	A20PLUS
V24A2	PGF1105
V27A	A11
V2F	A1
V39A	A33
V6A	A11
V6A	A1428
VF581	A97
WBF7608	A243004
DONALDSON	PARTMO
8943692991	AK570SP
C085004	AP2805
DBA5053	AP2705
DBA5069	AP3518
DBA5114	AP3936
DBA5296	AP4986
DBF5782	A7932SP
J8621420	AS88583SP
P119372	APCA502SY
P119373	AP106775
P119778	AP87658
P120484	AP25867SY
P123159	AP4000
P123160	AP2489
P124046	AP2621
P124047	AP4416
P127315	AP114215145
P133179	AP127313
P134353	AP5021
P134354	AP51250
P137640	AP137640
P141228	AP2632
P148043	AP2660
P150695	AP2680

DONALDSON	PARTMO
P153551	AP2705
P158661	AP4M8048
P158662	AP4M9335
P158664	AP4M9379
P164200	PM9M9740
P164904	PM64904
P164906	PM64906
P181002	APCA502
P181003	AP2482
P181004	AP57MD31
P181005	AP57MD21
P181007	AP117797
P181008	AP57MD33
P181014	AP2425
P181017	AP95600906
P181019	AP2520
P181019	AP2520H
P181028	AP182028
P181030	AP2576
P181030	AP2577
P181045	AP101234K
P181046	AP110558
P181050	AP101275K
P181052	AP101222K
P181054	AP101246K
P181062	AP2360
P181063	AP25867
P181070	AP2688
P181073	AP127312
P181080	AP812105
P181082	AP2216
P181103	AP4M8047
P181104	AP4M9334
P181105	AP4M9378
P181123	AP7N1225
P181137	AP2291
P181204	AP46530
P181208	AP46531
P182082	AP2216
P185034	AP4129908
P185069	AP3518
P185296	AP4986
P500008	AP3932
P500014	AP7242P
P500017	AP58010
P500026	AP3142
P500028	AP54100
P500030	AP31555
P500049	AP410
P500056	AP142
P500063	AP1312
P500064	AP2884
P500074	AP3137
P500077	AP323
P500083	AP16546
P500120	AP3193
P500125	AP67030
P500174	AP49064SY
P500179	AP2761
P500191	AP7242
P500198	AP17846
P500940	AP12020
P500941	AP12020SY

DONALDSON	PARTMO
P502007	A1402
P502007	A1402PLUS
P502008	A7028SP
P502015	A14476
P502015	A14476PLUS
P502015	A4041
P502016	A14302PLUS
P502016	A14302PLUS
P502016	A223
P502016	A223
P502019	A1406
P502019	A1406PLUS
P502032	A142SP
P502039	A350
P502042	A2700SP
P502042	A2700SP
P502043	A4271SP
P502049	A52
P502060	A7144SP
P502061	A092SP
P502061	A28SP
P502067	A58
P502067	A58PLUS
P502067	A58T
P502093	A7158SP
P502142	A093DSP
P502142	A093SP
P502149	AK570SP
P502163	A4053SP
P502169	P596
P502202	PM7572
P502226	PM1940
P502329	PFG44781
P502378	PP22135
P502390	PM72281SP
P502391	PP11690SP
P502405	PM54236E
P502413	A7144SP
P502425	PP11682
P502425	PP11682SP
P502426	PM1730SP
P502427	PP28970
P502431	PP2200C
P502433	A7133
P502475	A84400SP
P502492	PP5562
P502501	PM2240
P502502	PP24811
P502517	AS4654SP
P502530	PP1112
P502538	PM84001SP
P502597	PP88580
P503360	AP17871
P505192	AP35553
P505951	A4054SP
P505956	A4048SP
P505959	AP62636
P505961	AS1249SP
P505973	PP7355
P505978	PM2200
P505978	PP2200
P505988	PP7406
P505998	AP9S001

DONALDSON	PARTMO
P506036	PP7444
P506074	AP48772
P506079	AP31071
P506079	AP31081
P506087	PP80215
P506088	PP16328
P506092	AS46018SP
P506093	PP176AC
P506104	PP15562
P506145	AS36209SP
P506154	A4023SP
P524344	AP524344
P524355	AP121
P524377	AP4337
P524396	AP6261
P525130	AP1305
P526756	AP1861
P526873	AP3709
P527484	AP2863
P527680	AP3501
P527682	AP3518
P527683	AP3518SY
P527684	AP3518SY
P528223	AP2521
P529493	AP2863
P529601	AP5021
P529964	AP114215145
P532410	AP3988
P532966	AP2690
P533230	AP2712
P533230	AP2712A
P533232	AP3500
P533233	AP87657
P533235	AP2654
P533723	AP2654SY
P533890	AP3722
P533930	AP3548
P534104	AP3562
P534105	AP1323
P534544	AP5213SY
P534816	AP3539
P535365	AP4129907
P536425	AP1339
P536433	AP35793
P536457	AP3736
P536492	AP3737
P536577	AP17845
P536732	AP3707
P537286	AP3518SY
P538456	AP3722
P539470	AP2825
P543614	AP2877S
P546567	AP2741
P546597	AP3515
P548964	AP1365
P550008	A1
P550008	A1SP
P550010	PM1878100752
P550012	PFG516K
P550020	A26SP
P550025	A11
P550025	A12
P550026	PM988511911

DONALDSON	PARTMO
P550040	PM1878100270
P550040	PM1878100271
P550041	PM4031840025
P550042	PM9760
P550047	A111
P550047	A43S
P550048	A292
P550049	A305F
P550049	A3726
P550049	A3726SP
P550050	A50
P550051	A4011
P550052	PM126
P550057	A4054SP
P550059	PM9885132652
P550060	PM707
P550060	PM707E
P550066	PM53103E
P550067	A4731SP
P550073	A9003SP
P550086	A7223SP
P550092	PM192
P550104	A15
P550105	A23
P550105	A23SP
P550106	A1212SP
P550108	AR16SP
P550115	A70010
P550117	PM17
P550120	PM324
P550120	PM324E
P550126	PFG1105
P550127	A4047
P550132	PM197
P550157	A343
P550162	A323
P550162	A323PLUS
P550162	A4056
P550179	PM210
P550184	PM813
P550185	PM313
P550203	PM3
P550218	A30SP
P550219	A31SP
P550225	A034L
P550225	A4053SP
P550225	A5138SP
P550226	A232SP
P550227	A113
P550242	A291
P550248	A1226
P550252	A91T1
P550299	AR17
P550319	A309SP
P550335	A14302PLUS
P550342	A7174SP
P550342	A325SP
P550349	PM325
P550361	PP50361
P550367	A408SP
P550371	A3786SP
P550372	A7653
P550379	PM1650

DONALDSON	PARTMO
P550383	A4052SP
P550385	A7533DSP
P550387	AR29SP
P550388	AR29SP
P550389	A4051SP
P550390	A4886
P550390	A570DSP
P550390	AK570SP
P550391	A56670
P550400	A243
P550400	A243
P550404	PFG805
P550406	A1480
P550406	A28SP
P550408	A205SP
P550409	A4048SP
P550410	A330C
P550410	A941C
P550410	A941SP
P550412	A4049SP
P550422	A7144SP
P550425	A7685SP
P550428	A7177SP
P550431	A150F
P550440	A33358
P550453	PP12140
P550463	PM7680
P550467	PM19624SP
P550472	A1218
P550505	A1432
P550515	A1894
P550516	PM343
P550519	A67SP
P550520	A7898SP
P550521	PP40425
P550529	A8059
P550550	A1CSP
P550556	PFG7742
P550563	PP7196
P550564	PP71811
P550588	A1226LSP
P550597	A7029SP
P550597	A7029SP
P550599	A33
P550613	PM248
P550625	A7753SP
P550628	PP73018SP
P550629	PP7319SP
P550632	PP7735
P550639	A7174SP
P550657	PP19684SP
P550657	PP7779
P550671	A116CSP
P550674	PP246
P550688	A1226
P550688	A243004DSP
P550690	A11213DSP
P550690	A11213DSP
P550691	AS1282SP
P550719	A16242SP
P550729	A1345SP
P550729	AS830SP
P550731	A129SP

DONALDSON	PARTMO
P550736	PM19728SP
P550750	PMX750R
P550757	PM7680
P550758	A7306SP
P550761	PP9452
P550762	PP7761
P550762	PP7761
P550768	PP7199
P550769	PP7230SP
P550777	A777CSP
P550777	A777SP
P550778	AS88583SP
P550785	PP7777SP
P550794	A160
P550794	A160PLUS
P550819	PP15466
P550821	PP7986
P550824	PP7978
P550832	A84SP
P550834	A9894DSP
P550835	A7375SP
P550851	PM19765SP
P550861	PM28S1Z
P550866	AW2127SP
P550867	AW2127SP
P550880	A7813SP
P550880	A7813SP
P550881	A7813SP
P550928	A97C
P550932	A3726
P550933	A2863SP
P550934	A091AE
P550934	A4046
P550935	A4044
P550935	AR4M
P550936	A96C
P550939	A20
P550942	A7028SP
P550944	A1285DSP
P550947	A010
P550947	A105SP
P550947	A7041SP
P550949	A9080SP
P550954	PP9924KIT
P550963	AR1218
P550964	A1428
P550965	A329
P550967	PFG872
P550972	A494E
P550973	A7041SP
P550974	PFG323
P551000	A1259SP
P551000	AS1249SP
P551005	PP7505
P551008	PP5092
P551011	PM19915SP
P551019	A7177SP
P551034	A7301DSP
P551039	A11213DSP
P551047	AS1040SP
P551056	A7301DSP
P551063	PP9908KIT
P551086	A5813SP

DONALDSON	PARTMO
P551088	PP7494
P551100	A7898SP
P551103	AS1003SP
P551108	PP7508
P551124	A7929SPKIT
P551145	A7503SP
P551146	A40053SP
P551267	A7018
P551297	A7031
P551310	PP7751
P551313	A1P2299
P551315	A1R0751SP
P551318	A7629SP
P551323	A354
P551329	A787
P551343	A28SP
P551351	A7533SP
P551352	A7125
P551381	A205SP
P551434	AS7784D
P551441	A7105SP
P551475	PM174
P551523	A1006SP
P551550	A83910
P551551	A83910
P551603	A22SP
P551604	A349SP
P551605	A4618310
P551625	PP9914KIT
P551670	A116SP
P551670	A3612ASP
P551712	A614
P551740	A1P2299
P551760	PFG1104
P551807	A67SP
P551838	AS24030SP
P551839	AS46018SP
P551843	AS4654SP
P551845	AS4057SP
P551846	A1204SP
P551846	A1205SP
P551850	ASR45SP
P551852	AS1441SP
P551855	ASR90TSP
P551855	ASV90TSP
P551856	ASV90TSP
P551859	AS46018SP
P551864	AS1249SP
P551865	AS950SP
P551874	AS27177JSP
P551915	A915
P552010	PP201010
P552010	PP201030
P552020	PP202030
P552024	PP202030
P552025	A9025SP
P552032	AS1272SP
P552040	PP204030
P552050	A7105SP
P552050	A7105SP
P552055	AW2016SP
P552071	AW5137SP
P552072	AW2010SP

DONALDSON	PARTMO
P552073	AW2010SP
P552074	AW2016SP
P552096	AW2237SP
P552100	A495SP
P552200	A7766SP
P552372	PF423
P552381	AR9
P552392	PF61195
P552405	A7614SP
P552409	A4863
P552437	PF61163
P552441	PP8088
P552462	PM245
P552518	A20
P552518	A20PLUS
P552562	A1403SP
P552564	A7602
P552603	A588
P552603	A588SP
P552849	A73
P552849	A73PLUS
P553000	A3000SP
P553000	A3000SP
P553000	A3000SP
P553004	A243004
P553004	A243004SP
P553004	A33358
P553191	A67SP
P553211	A1259SP
P553226	AS5850SP
P553375	A1230
P553375	AS1230SP
P553411	A267
P553634	AR29SP
P553771	A840SP
P553855	A46SP
P553855	A888
P553871	A129SP
P553925	PM0011843925
P554004	A67SP
P554005	A69SP
P554071	AW5137SP
P554073	AW2010SP
P554347	A48MC
P554347	A48MC
P554407	AR17
P554422	AW2022SP
P554470	A7656E
P554470	A7656E
P554471	A7657
P554476	A7773SP
P554685	AW2010SP
P554770	A178PLUS
P554860	AW475SP
P555020	AS3202SP
P555570	A9N5570SP
P555616	A299E
P555627	A23L39
P555627	A23L39SP
P555680	A54SP
P555823	A85
P556245	P346P
P556287	P3461

DONALDSON	PARTMO
P556915	A96
P556916	A97
P556916	A97SP
P557440	A1P2299
P558000	A1212SP
P558000	ASV1212SP
P558010	A5813SP
P558250	A48SP
P558615	A339SP
P558616	A427SP
P558712	A43SP
P559000	A9080SP
P559125	A830
P559126	A129SP
P559127	A134
P559128	A9N6007SP
P559628	AS4654SP
P566922	A37110
P566922	A70015SP
P577063	PP79744
P577064	PF67802
P578571	PP52001SP
P579029	AS27177JSP
P579280	A7506SP
P580299	PP78091SP
P583308	A70020SP
P600676	AP3936
P604997	AP3545
P605022	AP5213
P606060	AP3568
P606061	AP3136
P606062	AP3574
P606073	AP126
P606076	AP4041
P606272	AP31550
P606284	AP3557
P606503	AP4636
P606720	AP4642
P607232	AP3129
P607238	AP147
P607250	AP3179
P607251	AP626
P607256	AP3134
P607258	AP35736
P607300	AP3135
P607301	AP31544
P607304	AP2300
P607306	AP311002
P607306	AP3118
P607326	AP3924
P607327	AP561
P607341	AP1292
P607346	AP3139
P607362	AP3138
P609239	AP4637
P609422	AP31037
P610903	AP10903
P611189	AP80006SY
P611190	AP80006
P611190	KITAP80006 / AP80006SY
P612827	AP31035
P613336	AP4862

DONALDSON	PARTMO
P613337	AP4863
P614221	AP43042
P614541	AP3570
P614543	AP35755
P614547	AP31036
P618899	AP2425
P618941	AP5627
P619859	AP17308
P621918	AP5628
P625287	AP4986
P625546	AP3270
P628181	AP8280
P629470	AP4863
P630867	AP5H100
P633099	AP25653
P633748	AP31753
P634451	AP5A500
P634614	AP78090
P635335	AP7242
P635977	AP5538
P636520	AP9993SY
P641165	AP23030
P641166	AP23030SY
P641355	AP5538SY
P645114	AP3936
P750003	AP84457SY
P755340	AP3988
P763995	A7927SP
P771003	AP2677
P771508	AP41702
P771561	APC203252
P772564	APSL5013Z40A
P772579	AP3542
P772580	AP3544P
P775302	AP3545
P776695	APC203252SY
P776696	AP41702SY
P776697	AP4091
P777421	APC203252
P777868	AP3870
P777869	AP3870SY
P778509	AP1908233
P778605	AP78605
P778989	AP3920
P778994	APC20500
P779908	PMX1878100501
P780030	AP3921
P780036	APC20500SY
P780848	AP3838
P781098	AP4989
P781466	AA5374
P782104	APC23610
P782107	APC23610SY
P782396	AP9961
P782857	AP49064
P782936	AP4971
P782937	AP4971SY
P784457	AP84457
P784525	AP4959
P786360	AP72154
P787609	AP72152
P801843	APCA502SY
P802507	APCA502SY

DONALDSON	PARTMO
P806251	APCA502SY
P806660	APCA502SY
P806766	AP106775
P811300	AP5021
P811413	AP110558
P811605	APCA502
P812105	AP812105
P812142	AP3736
P812160	AP2690
P812238	AP14210
P812300	AP5021
P812305	AP5021
P812311	AP5021
P812325	AP5021
P812330	AP2216
P812411	AP110558
P812649	AP3988
P815492	AP106775
P815860	AP101222K
P817642	AP2621
P821411	AP114215145
P821575	AP3716
P821908	AP821884
P821938	AP14210
P821963	AP14220
P822768	AP3988
P823366	AP51250
P827634	AP4416
P827653	AP3542
P829332	AP3543
P830169	AP3988
P831201	AP4416
P831424	AP3716
P832150	AP3736
P834085	AP2621
P838755	APCA502SY
P843355	AP14220
P846001	AP23030
P846920	AP21413
P847093	AP3542
P847863	AP23030SY
P847864	AP23030
P849069	AP78020
P849110	AP2279
P901512	AP4M8048
P902384	AP1325
P902385	AP1330E
P902609	APC010
P903530	AP31631
P903531	AP35781
P903539	AP31138
P903541	AP35977
P952185	AA5374
P953211	AP9993
P953329	PPI0771SP
P953571	AA5374
P954593	PF448
P954895	AS11001SP
P955466	AP84457SY
P955606	AS46018SP
RO03668	AP5538
RO10017	AS88583SP
RO10074	A8404OSP

DONALDSON	PARTMO
R10077	A7174SP
R61709	PP46235SP
DONSSON	PARTMO
DA2005	AP2205
DA2006	AP2206
DA2011	AP2211
DA2017	AP2217
DA2018	AP240
DA2024	AP4989
DA2032	AP2224
DA2042	AP4M9378
DA2047	AP4M8047
DA2049	AP4M9334
DA2071	AP101246K
DA2078	AP4M8048
DA2103	APCA502
DA2106	AP110558
DA2122	AP57MD33
DA2123	AP117797
DA2136	AP57MD31
DA2139	AP2425
DA2140	AP2482
DA2142	AP46530
DA2161	AP7N1225
DA2189	APC203252
DA2190	AP41702
DA2191	AP2291
DA2239	AP95600906
DA2244	AP3193
DA2246	AP16546
DA2259	AP2576
DA2260	AP2577
DA2264	AP812105
DA2265	AP182028
DA2304	AP5021
DA2315	AP2688
DA2343	AP2825
DA2346	AP4129907
DA2355	AP2825
DA2416	AP2216
DA2445	AP2520
DA2450	AP524344
DA2499	AP2712
DA2499	AP2712A
DA2513	AP2680
DA2523	AP2705
DA2524	AP3518
DA2524UHE	AP3518
DA2545	AP2632
DA2547	AP2863
DA2554	AP1130E
DA2570	AP3544P
DA2593	APH100
DA2594	AP3600
DA2612	AP10903
DA2654	AP2654
DA2663	AP3920
DA2665	AP3707
DA2666	AP3542
DA2667	AP127312
DA2671	AP3716
DA2690	AP2690
DA2691	AP1908233

DONSSON	PARTMO
DA2702	AP3548
DA2708	AP17308
DA2753	AP2677
DA2755	APG4800
DA2768	AP3539
DA2772	AP3988
DA2783	AP14210
DA2788	AP2877S
DA2828	AP7242P
DA2832	AP3736
DA2852	APC20500
DA2855	AP2688
DA2859	AP5H100
DA2860	AP45020
DA2869	AP3736
DA2872	APC23610
DA2882	AP20457
DA2900	AP2884
DA2901	AP8040
DA2919	AP5203
DA2923	AP78020
DA2926	AP4636
DA2932	AP8280
DA2933	AP9S001
DA2937	AP1325
DA2948	AP35433
DA2952	AP2660
DA2957	AP5627
DA2958	AP8A900
DA2959	AP2959
DA2968	AP17871
DA2969	AP17845
DA2970	AP72152
DA2970	AP84457
DA2974	AP4001
DA2975	AP16550
DA2976	AP3936
DA2982	AP4862
DA2984	AP3532
DA2995	APC010
DA2999	AP13190
DA3001	AP3193
DA3066	AP101222K
DA3067	AP101234K
DA3069	AP101275K
DA3071	AP101246K
DA3196	AP25867
DA3241	AP2360
DA3244	AP3193
DA3478	AP4000
DA3489	APL300
DA3593	AP3500
DA3636	AP87657
DA4042	AP4M9379
DA4047	AP4M8048
DA4049	AP4M9335
DA4066	AP2489
DA4103	APCA502SY
DA4106	AP106775
DA4136	AP57MD21
DA4142	AP46531
DA4189	APC203252SY
DA4190	AP41702SY

DONSSON	PARTMO
DA4191	AP4091
DA4196	AP25867SY
DA4227	AP127313
DA4264	AP114215145
DA4265	AP137640
DA4304	AP51250
DA4315	AP2621
DA4416	AP4416
DA4445	AP2521
DA4524	AP3518SY
DA4547	AP3501
DA4570	AP3545
DA4636	AP87658
DA4654	AP2654SY
DA4663	AP3921
DA4666	AP3543
DA4667	AP127313
DA4702	AP3722
DA4783	AP14220
DA4788	AP2877SY
DA4852	APC20500SY
DA4869	AP3737
DA4872	APC23610SY
DA4919	AP5217
DA4937	AP1330E
DA4957	AP5628
DA4968	AP17871SY
DA4969	AP17846
DA4982	AP4863
DA4999	AP13190SY
DA5557	AP186
DA5739	AP2562
DA7801	AP2805
DA8001	AP12020
DA8002	AP203823
DA8009	AP5538
DA8010	AP25653
DA8011	AP3270
DA8019	AP2236
DA8039	AP2239
DA8040	AP2240
DA8043	AP6A701
DA8044	AP2244
DA8049	AP5A500
DA8051	AP2251
DA8052	AP2252
DA8053	AP2253
DA8054	AP8054
DA8056	AP80006
DA8056	KITAP80006 / AP80006SY
DA8063	AP2263
DA8068	AP31874
DA8076	AP7C000
DA8093	AP4986
DA8093UHE	AP4986
DA8099	AP49064
DA8108	AP78090
DA8113	AP4959
DA8116	AP1030
DA8120	AP4642
DA8125	AP1063
DA8131	AP2231

DONSSON	PARTMO
DA8136	AP2236
DA8138	AP5213
DA8161	AP85051
DA8162	AP48772
DA8168	AP93019
DA8170	AP39601
DA8184	AP23030
DA8190	AP21413
DA8191	AP1126
DA8199	AP2299
DA8205	AP4971
DA8213	AP8213
DA8220	AP80220
DA8222	AP8222
DA8229	AP5M100
DA9001	AP12020SY
DA9009	AP5538SY
DA9048	AP2712SY
DA9056	AP80006SY
DA9099	AP49064SY
DA9118	AP84457SY
DA9138	AP5213SY
DA9184A	AP23030SY
DA9191	AP1126SY
DA9205	AP4971SY
DA9213	AP8213SY
DA9220	AP80220SY
DA9222	AP8222SY
DAC037	AP43042
DAC066	AP31739
DAC069	AP31037
DAC070	AP31002
DAC077	AP31033
DAC089	AP31026
DAC090	AP31081
DAC090A	AP31071
DAC093	AP31743
DAC097	AP31631
DAC136	AP31064
DAC139	AP31032
DAC153	AP31028
DAC161	AP31123
FA656	AP3567
GO03A	PP78091
GO03A	PP78091SP
G046	P346P
G047	P3461
G061	PFG516K
G076	PM210
G1002	PP79915SP
G1006	PP7444
G1114	AP31920
G124	PM325
G126	PP202030
G128	PP204030
G129	PP201010
G129	PP201030
G145	PM1878100752
G260	PP246
G369	P596
G431	PFG872
G445	PFG423
G454	PFG805

DONSSON	PARTMO
G479	PFG330
G489	PFG1104
G490	PFG1163
G491	PFG1105
G495	PP50361
G505	PP40425
G510	PFG7958
G525	PFG0120490B
G526	PFG335
G547	PFG1400
G578	PP7181
G578A	PP71811
G580	PM1940
G582	PFG3191102100
G590	PP27908
G596	PP6705
G597	PFG481I
G598	PFG368
G602	PFG405
G603	PM7680
G608	PP7199
G609	PP7735
G613	PFG357
G626	PM1650
G627	PM2240
G629	PP4780
G632	PP7777SP
G633	PM19624SP
G634	PM2200
G634	PP2200
G651	PM9760
G651	PM9760
G653	PFG25121074
G655	PFG367
G668	PP9452
G682	PFG3191102100
G682	PFG391
G708	PM84001SP
G722	PP16328
G722	PP6
G723	PP57061
G724	PP7399
G725	PP31060
G726	PP7230SP
G730	PP808010
G736	PP5562
G738	PM19765SP
G741A	PFG323
G746	PP7751
G747	PP2200C
G772	PP19684SP
G787	PP7406
G796	PFG448
G797	PP1112
G803	AP4494
G810	PP4780
G816	PP3C30A
G818	PP2F000
G820	PFG422
G824	PP85674
G827	PFG420
G833	PP28970
G839	PP88580

DONSSON	PARTMO
G843	PP24811
G843	PP24811
G844	PP11682
G844	PP11682SP
G868	PM1730SP
G874	PPFG460
G893	PP79744
G899	PP73018SP
G903	PP03009
G904	PP7455
G905	PP04041
G907	PP72321
G916	PPFG453
G917	PP15562
G929	PP176AC
G931	PP19925
G936	PP80472
G937	PP7476
G943	PP7978
G978	PP7505
G985	PP11690SP
G990	PPEV470
G991	PPEV430
G997	PP46235SP
GA1003	AP3536
GA1013	AP29400
GA1017	AP3557
GA1018	AP35741
GA1022	AP3117
GA1023	AP31697
GA1024	AP3144
GA1026	AP4439
GA1027	AP3107
GA1029	AP3559
GA1030	AP3132
GA1032	AP3134
GA1036	AP3120
GA1037	AP35602
GA1038	AP3190
GA1039	AP3113
GA1051	AP31711
GA1054	AP3127
GA1056	AP3145
GA1056A	AP31832
GA1057	AP3514
GA1061	AP31795
GA1062	AP31747
GA1063	AP3537
GA1064	AP35783
GA1066	AP1202
GA1066	AP35815
GA1068	AP35755
GA1070	AP3191
GA1071	AP31734
GA1075	AP31820
GA1077	AP31744
GA1078	AP35750
GA1079	AP35844
GA1081	AP31796
GA1082	AP31797
GA1084	AP351833
GA1089	AP35915
GA1092	AP31857

DONSSON	PARTMO
GA1093	AP352660
GA1094	AP35917
GA1096	AP31461
GA1097	AP311002
GA1103	AP31942
GA1107	AP35898
GA1108	AP31992
GA1110	AP35862
GA1115	AP31899
GA1117	AP31963
GA1120	AP31962
GA1122	AP35968
GA1123	AP35961
GA1127	AP35977
GA1127	AP35977
GA1130	AP31935
GA1133	AP31985
GA1137	APG6000
GA157	AP127
GA204	AP4041
GA247	AP126
GA254	AP410
GA287	AP323
GA287A	AP323A
GA330	AP4337
GA388	AP1305
GA459	AP531
GA539	AP35645
GA540	AP35758
GA544	AP1312
GA558	AP05113
GA584	AP3130
GA589	AP1339
GA590	AP31550
GA596	AP1323
GA601	AP3520
GA605	AP3562
GA611	AP3932
GA613	AP3179
GA624	AP3101
GA625	AP1292
GA625	AP3137
GA626	AP35644
GA628	AP3517
GA632	AP3574
GA634	AP3119
GA638	AP146
GA643	AP35553
GA646	AP31559
GA646	AP3509
GA651	AP3178
GA657	AP3579
GA678	AP3582
GA679	AP3121
GA680	AP31622
GA684	AP1298
GA686	AP1294
GA694	AP3527
GA704	AP3129
GA706	AP31544
GA707	AP31511
GA709	AP3118
GA710	AP1375

DONSSON	PARTMO
GA714	AP3568
GA716	AP3138
GA717	AP1347
GA718	AP3170
GA719	AP3133
GA722	AP31585
GA725	AP3533
GA727	AP561
GA730	AP31528
GA735	AP3176
GA737	AP603A
GA740	AP1365
GA741	AP1087
GA744	AP05120
GA746	AP3578
GA749	AP35793
GA756	AP1275
GA757	AP537
GA758	AP3128
GA759	AP3563
GA763	AP2021
GA763A	AP3109
GA766	AP1330
GA774	AP3123
GA775	AP3136
GA776	AP3124
GA777	AP31563
GA779	AP3515
GA784	AP3142
GA786	AP3195
GA807	AP3140
GA809	AP3139
GA814	AP35606
GA822	AP3554
GA824	AP3709
GA829	AP3181
GA830	AP31551
GA833	AP31555
GA834	AP2600
GA836	AP2510
GA842	AP35590
GA847	AP3524
GA850	AP3138
GA866	AP3511
GA868	AP0978
GA875	AP3513
GA876	AP3125
GA884	APSL40A
GA890	AP6293
GA892	AP31588
GA893	AP31678
GA903	AP3581
GA905	AP3570
GA907	AP67030
GA912	AP31653
GA934	APC301251
GA939	AP35672
GA943	AP35591
GA943	AP35665
GA944	AP3114
GA950	AP3531
GA951	AP3550
GA967	AP3450

DONSSON	PARTMO
GA968	AP35660
GA971	AP3108
GA971	AP3565
GA974	AP3116
GA975	AP31834
GA976A	AP35786
GA976A	AP35786
GA979	AP3102
GA980	AP3196
GA981	AP3115
GA981	AP3143
GA985	AP3112
GA987	AP4495
GA989	AP31701
GA991	AP3588
GA992	AP1000
GA995	AP3122
GA996	AP31628
GA998	AP3111
GA998	AP3511
GC054	A116SP
GC156	A134
GC163	A1212SP
GC163	ASV1212SP
GS001	A1
GS001	A1SP
GS002	A11
GS004	A50
GS006	A4046
GS011A	A1CSP
GS014	A1P2299
GS014	A1P2299
GS014A	A23
GS014A	A23SP
GS015	A15
GS017	A46SP
GS017	A46SP
GS017	A888
GS018A	A840SP
GS019	A48MC
GS021	AR17
GS022	A54SP
GS023A	A48SP
GS025	A43SP
GS025	A787
GS025	A787
GS026	A4618310
GS029	AR29SP
GS030	A30SP
GS030	A30SP
GS031	A31SP
GS031	A31SP
GS032	A22SP
GS033	A85
GS034	A150F
GS034	A150F
GS035	A243004
GS035	A243004SP
GS035	A33358
GS036	A9N5570SP
GS037	A67SP
GS038	A69SP
GS039	AR46

DONSSON	PARTMO
GS041	A33
GS042	A12
GS043	A113
GS044	A243
GS044A	A178PLUS
GS045	A73
GS045	A73PLUS
GS046	A20
GS046	A20PLUS
GS047	AR1218
GS048	A84SP
GS049	A26SP
GS049	A26SP
GS050	A372
GS050A	A18
GS050A	A18PLUS
GS051	A4041
GS052	A323
GS052	A323PLUS
GS053	A4044
GS056	A349SP
GS056	A840SP
GS060	A1226
GS060	A243004DSP
GS060	A243004DSP
GS062	A96
GS063	A97
GS063	A97SP
GS064	A96C
GS065	A97C
GS068	A15403
GS070	A111
GS070	A43S
GS072	A116CSP
GS072	A3612ASP
GS076	A941C
GS076A	A330C
GS076A	A941SP
GS077	A777SP
GS077A	A7685SP
GS078	AW2010SP
GS078	AW5137SP
GS078A6	AW2010SP
GS079	A4011
GS081	AW2016SP
GS082	A305F
GS082	A3726
GS082	A3726SP
GS083	A1894
GS084	AW475SP
GS086	A9N6007SP
GS088	A915
GS091	A4054SP
GS092	A4044
GS092	AR9
GS093	AR4M
GS096	A23A
GS096	A23ASP
GS100	A343
GS104	A7602
GS106	A4048SP
GS109	A427SP
GS110	A91T1

DONSSON	PARTMO
GS111	A339SP
GS112	A105SP
GS115	A4886
GS115	A570DSP
GS115	AK570SP
GS122	AW2022SP
GS129	A291
GS134	A23L39
GS134	A23L39SP
GS136	A205SP
GS137	A350
GS137	A4731SP
GS138	A4049SP
GS141	A3000SP
GS141	A3000SP
GS145	A58
GS145	A58PLUS
GS145	A58T
GS147	A1432
GS157	A309SP
GS159	A4051SP
GS160	A4052SP
GS161	A588
GS161	A588SP
GS163A	A1212SP
GS163A	ASV1212SP
GS167	A7177SP
GS168	A1204SP
GS168A	A1205SP
GS168A1	AS1282SP
GS168A1	ASV1282SP
GS171	AW2237SP
GS172	A1230
GS180	A5813SP
GS180	AS3202SP
GS185	A091AE
GS189	A52
GS189	A53PLUS
GS191	A1345SP
GS191	AS830SP
GS197A1	AS1249SP
GS198	A56670
GS199	A9003SP
GS201	A3802N
GS202	A408SP
GS203	A329
GS206	A093DSP
GS206	A093SP
GS207	A092SP
GS207	A7028SP
GS208	A614
GS210	A1218
GS211	A325SP
GS212	A232SP
GS213	A14476
GS213	A14476PLUS
GS217	A3786SP
GS218	A7158SP
GS222	A1403SP
GS232	A1402
GS232	A1402PLUS
GS235A	A7533DSP
GS235A	A7533SP

DONSSON	PARTMO
GS236	A1259SP
GS237	A1480
GS240	A1428
GS241	A3603
GS241	A3603PLUS
GS244	A7041SP
GS244A	A205SP
GS247	A142SP
GS249	A1R0751SP
GS249	A1R0751SP
GS250	A7018
GS251	A7029SP
GS251	A7029SP
GS252	A11213DSP
GS253	A70015SP
GS254	A14302PLUS
GS254	A223
GS254	A4050
GS254	A4050PLUS
GS256	A4056
GS258	A7105SP
GS259	A1406
GS259	A1406PLUS
GS263	A4053SP
GS264	A7105SP
GS267	A7125
GS268	A4271SP
GS268	A4271SP
GS270	AS1441SP
GS270	ASR45SP
GS270	ASV45SP
GS271	AS950SP
GS273	A830
GS275	A28SP
GS275	A28SP
GS278	A2863B
GS278	A2863SP
GS281	A7656E
GS282	A7657
GS283	AS201SP
GS284	A7301DSP
GS286	A9080SP
GS287	ASV1060SP
GS289	AA5374
GS295	A2700SP
GS299	A4047
GS303	AW2127SP
GS305	AS103SP
GS307	A4050
GS307	A4050PLUS
GS310	AS1040SP
GS311	A7898SP
GS314	A7813SP
GS318	A7653
GS321	A7753SP
GS329	A292
GS331	A5368SP
GS340	A7533C
GS343	A1CSP
GS363	A8059
GS365	A777CSP
GS375	AS4654SP
GS383A10	AS27177JSP

DONSSON	PARTMO
GS407	A14302PLUS
GS411	A84040SP
GS453	A7223SP
GS461	A70020SP
GS489	A52
GS489	A53PLUS
GS498	A16242SP
GS501	A70010
GS504	A354
GS505	A7813SP
GS510	A292
GS536	AR90D
GS536	ASR90TSP
GS536	ASV90TSP
GS540	PP5706
GS545	A129SP
GS552	A14616
GS552	A14616PLUS
GS554	A243004DSP
GS554	A243004DSP
GS564	AS46018SP
GS585	AS5850SP
GS597	A7773SP
GS627	A7301DSP
GS659	A52041SP
GS665	PP17356
GS679	AS1228SP
GS680	AS36209SP
GS687	AS27177JSP
GS699	A7503SP
GS701	A1218
GS727	A23251SP
GS738	A52041SP
GS923	AS12226SP
GS924	A26000SP
FLEETGUARD	PARTMO
3826094	PF323
111700197	PP5706
3300391S	A96
3300392S	A97
3300392S	A97SP
40C0433	A1259SP
40C0434	A9080SP
53C0052	A33358
53C0053	A3000SP
53C0054	A339SP
AA2902	AP106775
AA2902	AP110558
AA2910	AP57MD21
AA2911	AP57MD31
AA2912	AP114215145
AA2920	APCA502SY
AA2925	AP106775
AF10124	APH100
AF140SL	AP3125
AF1606K	AP2360
AF1624	AP4041
AF1625	AP147
AF1640	AP46531
AF1641	AP46530
AF1697	APR9
AF1700	AP25867SY
AF1720	AP4337

FLEETGUARD	PARTMO
AF1735K	AP25867
AF1763M	AP812105
AF1767	AP114215145
AF1768	AP812105
AF1768M	AP812105
AF17693	AP2877S
AF1777	AP626
AF1780	AP126
AF1791	APCA502SY
AF1791M	APCA502SY
AF1797M	AP2632
AF1815	AP2576
AF1815M	AP2576
AF1816	AP2576
AF1816	AP2577
AF1818M	AP2632
AF1820	AP7N1225
AF1820M	AP7N1225
AF1822	AP16546
AF1838	AP2660
AF1840	APC203252SY
AF1843	AP4091
AF1846	AP2660
AF1862M	AP5021
AF1862MT52223	AP5021
AF1863M	AP51250
AF1863MT5222	AP51250
AF1889	AP121
AF1904M	AP106775
AF1918K	AP101246K
AF1918KM	AP101246K
AF1934M	AP2688
AF1935M	AP2621
AF1956KM	AP4000
AF1965M	AP2677
AF1966	AP2489
AF1968	AP2705
AF1968M	AP2705
AF1969	AP2680
AF1969M	AP2680
AF25017	AP31511
AF25033	AP2654
AF25033M	AP2654
AF25044M	APC203252
AF25047	AP2621
AF25064	APC203252
AF25070K	AP101222K
AF25075	AP17308
AF25139	AP3518
AF25139M	AP3518
AF25175	AP8280
AF25181	AP72152
AF2521	AP114215145
AF25215	AP3501
AF25220	AP2863
AF25223	AP2690
AF25247	AP3539
AF25256	AP1339
AF25258	AP3707
AF25259	AP3707
AF25260	AP1908233
AF25268	AP1063
AF25276	AP12020

FLEETGUARD	PARTMO
AF25277	AP12020SY
AF25287K	AP101246K
AF25291	AP3542
AF25292	AP3544P
AF25308	AP3988
AF25319	AP3570
AF25345	AP3518SY
AF25352	AP3544P
AF25354	AP3548
AF25355	AP3548
AF25359	AP3548
AF25360	AP3722
AF25372	AP2884
AF25379	AP35553
AF25383	AP17845
AF25385K	AP3193
AF25395KM	APCA502
AF25399	AP05113
AF25412	AP14220
AF25413	AP821884
AF25414	AP14210
AF25416	AP3736
AF25423	AP35793
AF25428	AP3838
AF25429	AP3722
AF25430	AP2654SY
AF25431	AP2712
AF25436	AP3988
AF25438	AP7242P
AF25451	AP812105
AF25484	AP3543
AF25485	AP3545
AF25500K	AP3193
AF25505	AP3988
AF25520	AP3545
AF25526	AP3542
AF25553	AP3988
AF25555	AP3542
AF25555	AP3542
AF25556	AP3543
AF25557	AP3544P
AF25558	AP3545
AF25560	AP17845
AF25561	AP17846
AF25565	AP3920
AF25566	AP3921
AF25584M	AP67030
AF25588	AP3542
AF25589	AP3736
AF25590	AP3515
AF25592	AP3545
AF25609	AP3118
AF25624	AP3737
AF25631	AP49064
AF25632	AP9961
AF25653	AP25653
AF25667	AP2690
AF25684	AP1365
AF25687	AP3936
AF25707	AP4636
AF25723	APC20500
AF25724	APC20500SY
AF25729	APC23610

FLEETGUARD	PARTMO
AF25730	APC23610SY
AF25732	AP4637
AF25758M	AP2576
AF25758M	AP2577
AF25956	AP31035
AF25975	AP4959
AF25997	AP5627
AF25997	AP5628
AF26036M	APCA502SY
AF26103	AP4862
AF26107	AP4636
AF26131	AP35755
AF26163M	AP4642
AF26211	AP5628
AF26235	AP31037
AF26242	AP84457
AF26268	AP4863
AF26303	AP3515
AF26305	AP126
AF26306	AP1305
AF26307	AP1323
AF26309	AP1339
AF26319	AP3707
AF26321	AP1312
AF26323	AP31544
AF26324	AP3574
AF26328	AP2705
AF26328M	AP2705
AF26375	AP3570
AF26391	AP3920
AF26392	AP3921
AF26395	APC20500
AF26395	APC20500
AF26396	APC20500SY
AF26396	APC20500SY
AF26397	APC23610
AF26398	APC23610SY
AF26427	AP31036
AF26430	AP43042
AF26457	APG4800
AF26475	AP3270
AF26501	APC010
AF26509	AP2231
AF26513	AP2279
AF26520	AP1330E
AF26521	AP17871SY
AF26522	AP1325
AF26523	AP17871
AF26525	AP78020
AF26531	AP1126
AF26532	AP1126SY
AF26536	AP5213SY
AF26536	AP5213SY
AF26537	AP5213
AF26537	AP5213
AF26569	AP5538
AF26570	AP5538SY
AF27690	AP7242
AF27693	AP2877S
AF27817	AA5374
AF27948	AP4986
AF284	AP3709
AF311	AP31511

FLEETGUARD	PARTMO
AF3229	AP137640
AF335	AP4M9334
AF335M	AP4M9334
AF337	AP4M9378
AF338	AP4M9335
AF339	AP4M9335
AF341	AP4M9379
AF342	AP4M9379
AF343	AP4M8048
AF344	AP4M8047
AF344M	AP4M8047
AF350K	AP101234K
AF350KM	AP101234K
AF400	AP121
AF4040	APC203252
AF405	AP6261
AF4060	AP2291
AF409K	AP101246K
AF4102	AP1365
AF411	AP3129
AF4150	AP87658
AF4164K	APSL5013Z40A
AF4172	AP72154
AF4181	AP80006
AF4181	KITAP80006 / AP80006SY
AF4182	AP80006SY
AF4184	AP4959
AF4232	AP9S001
AF4235	AP31753
AF4239	AP9S001
AF424	AP110558
AF435K	AP101275K
AF435KM	AP101275K
AF437K	AP101222K
AF437KM	AP101222K
AF43K	AP101222K
AF4506	AP2761
AF4506M	APCA502
AF4507	AP57MD31
AF4507M	AP57MD31
AF4508	AP812105
AF4509	AP1861
AF4510	AP2489
AF4512	AP4M8048
AF4513	AP4M9335
AF4567	AP4129907
AF4579	AP2521
AF4593	AP3562
AF4602	AP3924
AF4615	AP1312
AF4618	AP323
AF4624	AP1305
AF4652	AP31550
AF4668	AP2741
AF4696	AP2825
AF4697	AP2761
AF4700K	AP3500
AF4702	AP2712
AF4703	AP106775
AF471	APCA502SY
AF4711	AP127312
AF471M	APCA502SY

FLEETGUARD	PARTMO
AF472	APCA502
AF4733	AP2712
AF4733	AP2712A
AF4739	AP2761
AF4763	AP101222K
AF4764	AP101222K
AF4801	AP127312
AF4828	AP127313
AF4828Q	AP127313
AF484	AP4M9379
AF4865M	AP812105
AF4866	AP51250
AF4877	AP2712
AF4877	AP2712A
AF4878	AP2863
AF4888K	AP2360
AF490	AP4129908
AF4902	AP2688
AF4903	AP5021
AF4908	AP3518
AF490K	AP4129908
AF490M	AP4129908
AF4941K	AP101246K
AF4944	AP3932
AF4953	AP1330
AF4956	AP3179
AF4959	AP3129
AF4963	AP603A
AF4964	AP3142
AF4965	AP1323
AF4974	AP2300
AF4975	AP3179
AF4978	AP142
AF4986	AP524344
AF4990	AP524344
AF55715	AP31631
AF55729	AP31035
AF56021	AP31071
AF807K	AP101222K
AF820M	AP106775
AF829	AP101246K
AF852	AP57MD33
AF852M	AP57MD33
AF853	AP117797
AF853M	AP117797
AF886	AP2425
AF886M	AP2425
AF8916	AP45020
AF910	AP57MD21
AF910M	AP57MD21
AF911	AP57MD31
AF911M	AP57MD31
AF942	AP2520
AF942	AP2520H
AF942M	AP2520
AF960	AP95600906
AF960M	AP95600906
AF966	AP2482
AF966M	AP2482
AF970	AP2291
AF975M	AP2216
AF976	AP4416
AF979	AP182028

FLEETGUARD	PARTMO
AF979M	AP182028
AF987	AP137640
AFL1524HD	AP3532
AFL2158	AP3120
AH1107	AP2805
AH1157	AP46530
AH19072	AP106775
AH19088	AP3988
AH19095	AP3544P
AH19096	AP3544P
AH19097	AP3544P
AH19098	AP3544P
F4033	PM325
FF102	PM192
FF104	A15
FF105	A23
FF105	A23SP
FF1055	A70015SP
FF105C	A1212SP
FF105D	A106
FF105D	A1212SP
FF105D	ASV1212SP
FF105HP	A1259SP
FF132	PM210
FF146	PM707
FF146	PM707E
FF147	PM28S1Z
FF147	PM28S1Z
FF149	PFG516K
FF165	A7813SP
FF167	P346P
FF167A	P346P
FF171	A30SP
FF171	A30SP
FF172	A31SP
FF172	A31SP
FF182	A46SP
FF182	A588
FF182	A588SP
FF184	A23L39
FF184	A23L39SP
FF185	A1P2299
FF185	A1P2299
FF185J	A1P2299
FF185J	A1P2299
FF192	A1P2299
FF192	A1P2299
FF194	A1212SP
FF198	AR16SP
FF200	A43SP
FF206	A97
FF206	A97SP
FF207	A96
FF209	A46SP
FF209	A46SP
FF209	A888
FF211	A85
FF215	A1226LSP
FF215	A243004DSP
FF216	A48MC
FF217	PP202030
FF2200	A7766SP
FF222	A150F

FLEETGUARD	PARTMO
FF222	A150F
FF225	PM28S1Z
FF233	A330C
FF233	A941C
FF233	A941SP
FF235	A96C
FF246	PP246
FF246	PP246
FF253	A292
FF254	A8059
FF260	PFG7802
FF4013	A243004
FF4013	A243004SP
FF4013	A33358
FF4052	P3461
FF4052A	P3461
FF4062	A1226LSP
FF4062	A33358
FF4062	A33358L
FF4063	A1226LSP
FF4077	A4618310
FF4136	A330C
FF4141	PM324
FF4141	PM324E
FF42000	A243004
FF42000	A243004SP
FF42003	A4047
FF5006	PFG323
FF5011	A915
FF5012	A70010
FF5013	A915
FF5015	PFG516K
FF5016	PFG516K
FF5018	A243004
FF5018	A33358
FF5019	A588
FF5019	A588SP
FF5020	A23L39
FF5020	A23L39SP
FF5021	A97C
FF5029	PM988511911
FF5030	A4053SP
FF5034	A1285DSP
FF5038	A787
FF5039	A4618310
FF5052	A33358
FF5053	PM324
FF5053	PM324E
FF5054	PM325
FF5056	A787
FF5058	A330C
FF5060	A1226LSP
FF5067	A46SP
FF5067	A888
FF5074	A243004
FF5074	A33358
FF5074CS	A243004
FF5076	A1P2299
FF5078	A588
FF5079	PFG323
FF5081	A4053SP
FF5083	PM1878100270
FF5084	PM1878100270

FLEETGUARD	PARTMO
FF5084	PM1878100271
FF5085	PM9760
FF5087	A292
FF5088	A292
FF5088	A305F
FF5088	A3726
FF5088	A3726SP
FF5089	A3726
FF5092	A4053SP
FF5094	A4618310
FF5097	PFG1105
FF5098	PFG323
FF5100	PM324
FF5100	PM324E
FF5100	PM707
FF5100	PM707E
FF5106	A4047
FF5108	A7602
FF5114	A034L
FF5114	A5138SP
FF5127	A56670
FF5128	A034L
FF5128	A4053SP
FF5128	A5138SP
FF5129	A4047
FF5135	A1226LSP
FF5135	A243004DSP
FF5137	A15
FF5138	A034L
FF5138	A5138SP
FF5139	A1226LSP
FF5141	A7602
FF5147	A4047
FF5148	A15
FF5151	A7301DSP
FF5156	A1226LSP
FF5157	A1P2299
FF5157	A1P2299
FF5158	A4053SP
FF5159	A7533DSP
FF5159	A7533SP
FF5160	A4886
FF5160	A570DSP
FF5160	AK570SP
FF5161	A23
FF5165	A4886
FF5167	A243004
FF5167	A33358
FF5172	A4053SP
FF5174	PFG805
FF5176	PFG1105
FF5177	PFG423
FF5180	PFG1104
FF5186	PFG1195
FF5190	PFG1104
FF5206	A97
FF5206	A97SP
FF5207	A96
FF5213	PFG805
FF5214	PFG44781
FF5218	PFG44781
FF5219	A305F
FF5219	A3726

FLEETGUARD	PARTMO
FF5223	PFG1191
FF5226	A4047
FF5227	A97
FF5228	PM28S1Z
FF5229	A093DSP
FF5229	A093SP
FF5231	A4053SP
FF5244	PFG872
FF5245	A1P2299
FF5245	A1P2299
FF5253	A1212SP
FF5255	A305F
FF5255	A3726
FF5255	A4047
FF5264	A614
FF5266	A7614SP
FF5269	A588SP
FF5271	A33358
FF5272	A7653
FF5278	PM7680
FF5287	P596
FF5297	A1894
FF5300	A4047
FF5301	A830
FF5304	A330C
FF5304	A941SP
FF5307	A7533SP
FF5309	A1R0751SP
FF5309	A1R0751SP
FF5311	A97
FF5314	PM7680
FF5315	PM7680
FF5316	A305F
FF5316	A3726
FF5321	A1R0751SP
FF5324	A1R0751SP
FF5332	A23
FF5334	A15
FF5335	A97C
FF5347	A30SP
FF5347	A30SP
FF5348	A150F
FF5363	PM1940
FF5367	A56670
FF5368	A5368SP
FF5369W	PM7680
FF5376	A23
FF5380	PP7735
FF5381	A1218
FF5381	A7656E
FF5382	A7657
FF5394	A3627
FF5401	A4047
FF5405	PP7761
FF5407	A4886
FF5412	A7533DSP
FF5420	A7813SP
FF5421	A7813SP
FF5424	A1894
FF5432	A7533DSP
FF5443	A7653
FF5451	A4054SP
FF5457	A1218

FLEETGUARD	PARTMO
FF5485	A7813SP
FF5494	A33358
FF5507	A8059
FF5578	A23
FF5582	PM707
FF5582	PM707E
FF5612	A7813SP
FF5626	A1894
FF5632	A7813SP
FF5643	A7773SP
FF5666	PFG872
FF5680	PFG1163
FF5702	A7653
FF5704	PFG1163
FF5706	PP5706
FF5721	PM1940
FF5725	PP7751
FF5732	PP11682
FF5732	PP11682SP
FF5733	PP11690SP
FF5764	PP7355
FF5765	PP7444
FF5773	PFG448
FF5797	PP22135
FF5856	A830
FF5973	PP04041
FF851	A588C
FF955	A150F
FF955	A150F
FK48001	A7929SPKIT
FL3684	A1403SP
FS1000	A1212SP
FS1000	A1259SP
FS1001	A1212SP
FS1003	AS1003SP
FS1003B	AS1003SP
FS1005	PM7680
FS1007	AS1040SP
FS1016	PM7680
FS1029	PM7680
FS1029W	PM7680
FS1031	AS1040SP
FS1040	AS1040SP
FS10402	PP204030
FS1041	AS1040SP
FS1065	AS1003SP
FS1067	AS1003SP
FS1206	PP202030
FS1207	PP204030
FS1208	PP201010
FS1208	PP201030
FS1208N1	PP201010
FS1212	A1212SP
FS1212	ASV1212SP
FS1212W	A1212SP
FS1213	A5813SP
FS1214	A1212SP
FS1215	A1212SP
FS1220	A1212SP
FS1221	A1226
FS1221	A243004DSP
FS1221	A243004DSP
FS1222	A1212SP

FLEETGUARD	PARTMO
FS1222	ASV1212SP
FS1225	A1212SP
FS1226	A1226
FS1233	AS1282SP
FS1233B	AS1282SP
FS1234	A1204SP
FS1234	AS4057SP
FS1234B	AS4057SP
FS1235	A11213DSP
FS1235	A11213DSP
FS1241	AS1282SP
FS1241	ASV1282SP
FS1242	AS1249SP
FS1242	AS1249SP
FS1243	A5813SP
FS1245B	A1212SP
FS1247	A1205SP
FS1251	A1226
FS1274	AS4057SP
FS1276	A1226LSP
FS1278	A1230
FS1280	A787
FS1281	A1230
FS1281	AS1230SP
FS1281	AS1441SP
FS1282	AS1282SP
FS1287	A7301DSP
FS1287	AS1441SP
FS1291	AS5850SP
FS1291	AS830SP
FS1293	PP202030
FS1294	PP204030
FS19250	A26SP
FS19250	A26SP
FS19513	A5813SP
FS19520	AS3202SP
FS19522	PP7751
FS19528	PP7751
FS19536	PM7680
FS19536W	PM7680
FS19547	A1345SP
FS19548	A1345SP
FS19551	AR90D
FS19551	ASR90TSP
FS19551	ASV90TSP
FS19558	PM7680
FS19574	AR90D
FS19574	ASR90TSP
FS19575	PP201010
FS19580	A9894DSP
FS19581	A11213DSP
FS19587	AS103SP
FS19592	A1212SP
FS19593	AS5850SP
FS19594	A1CSP
FS19596	AS1003SP
FS19597	A1226LSP
FS19598	PP7751
FS19613	PM19624SP
FS19624	PM19624SP
FS19634	A1212SP
FS19684	PP19684SP
FS1968400E	PP19684SP

FLEETGUARD	PARTMO
FS19684E	PP19684SP
FS19687	A7301DSP
FS19687	AS1441SP
FS19728	PM19728SP
FS19735	AS4654SP
FS19739	A11213DSP
FS19761	PM19624SP
FS19765	PM19765SP
FS19765G	PM19765SP
FS19769	AS88583SP
FS19775	ASR45SP
FS19775	ASV45SP
FS19781	AS200SP
FS19830	AS7784D
FS19914	AS46018SP
FS19920	AS11001SP
FS19925	PP19925
FS19930	A7301DSP
FS19931	A7301DSP
FS19932	AR90D
FS19944	A1204SP
FS19944	A7301DSP
FS19947	PP7978
FS19965	A1285DSP
FS20040	AS46018SP
FS20102	PP201010
FS20102	PP201030
FS20110	AR90D
FS20110	ASR90TSP
FS20176	PP46235SP
FS20201	PP202030
FS20202	PP202030
FS20401	PP204030
FS20402	PP204030
FS20403	PP204030
FS36209	AS36209SP
FS36212	PM1730SP
FS36243	PP28970
FS36247	A1345SP
FS36253	A1212SP
FS36267	AS88583SP
FS36268	AS36268SP
FS5327	A1226
H4017	A48SP
HC6056	A83910
HF287783	A14302PLUS
HF28783	A14302PLUS
HF28810	A91T1
HF28893	A7223SP
HF28922	A83910
HF30014	A70015SP
HF30399	A70015SP
HF30606	PP201010
HF35042	A9N5570SP
HF35323	A9N5570SP
HF35539	PM9M9740
HF6010	AR29SP
HF6055	A48SP
HF6056	A83910
HF6058	A83910
HF6065	A54SP
HF6080	A54SP
HF6097	PM9M9740

FLEETGUARD	PARTMO
HF6115	A354
HF6116	A70015SP
HF6117	A70015SP
HF6118	PM197
HF6121	A83910
HF6123	A354
HF6125	AR29SP
HF6127	A70015SP
HF6130	AR29SP
HF6130CEL	AR29SP
HF6133	A91T1
HF6133CEL	A91T1
HF6135	A91T1
HF6135CEL	A91T1
HF6136	A91T1
HF6136CEL	A91T1
HF6137	A91T1
HF6137CEL	A91T1
HF6138	A91T1
HF6138CEL	A91T1
HF6141	A840SP
HF6157	A91T1
HF6158	A14302PLUS
HF6158	A4041
HF6163	A91T1
HF6163CEL	A91T1
HF6167	AR29SP
HF6167CEL	AR29SP
HF6188	A4863
HF6206	A54SP
HF6270	A91T1
HF6280	A48SP
HF6281	A70015SP
HF6303	AR29SP
HF6358	A91T1
HF6361	A54SP
HF6393	PM9M9740
HF6439	AR29SP
HF6439CEL	AR29SP
HF6457	A54SP
HF6500E	A54SP
HF6505	A83910
HF6510	A83910
HF6520	A83910
HF6600	A70015SP
HF6610	A70015SP
HF6612	A70015SP
HF6620	A70015SP
HF6625	A70015SP
HF6634	A70015SP
HF6679	A70015SP
HF6681	A70015SP
HF6710	A91T1
HF6711	A91T1
HF6718	AR29SP
HF6720	AR29SP
HF6720CEL	A91T1
HF6721	A91T1
HF6736	A91T1
HF7569	A9N6007SP
HF7608	A83910
HF7996	A91T1
KC198	A1226LSP

FLEETGUARD	PARTMO
LF14000NN	A9080SP
LF16002	A329
LF16012	A091AE
LF16015	A7898SP
LF16034	A323
LF16046	PP7230SP
LF16050	A323
LF16101	A67SP
LF16104	A1432
LF16110	A7105SP
LF16115	A113
LF16144	PP9452
LF16175	A67SP
LF16176	PP5562
LF16208	A1
LF16209	A11
LF16210	A20
LF16210	A20PLUS
LF16213	A111
LF16214	A329
LF16215	A20
LF16215	A20PLUS
LF16215	AR1218
LF16218	A1432
LF16242	A160
LF16242	A160PLUS
LF16249	PM2200
LF16249	PP2200
LF16252	A2210SP
LF16255	A4271SP
LF16255	A4271SP
LF16285	A7174SP
LF16317	PP7406
LF16325	A14302PLUS
LF16328	PP16328
LF17356	PP17356
LF17480	PP72321
LF17501	PP88580
LF17502	A7685SP
LF17518	A1480
LF17543	A113
LF17559	A3612ASP
LF1935M	AP2621
LF219E	PM197
LF219LUBE	PM197
LF2344	A134
LF3000	A3000SP
LF3000	A3000SP
LF3000TP	A3000SP
LF3000TP	A3000SP
LF3000X	A3000SP
LF3306	A1
LF3306	A1SP
LF3307	A299E
LF3309	A20
LF3309	A20PLUS
LF3309	AR1218
LF3310	A18
LF3310	A18PLUS
LF3310	A20
LF3310	A20PLUS
LF3313	A1
LF3313	A1SP

FLEETGUARD	PARTMO
LF3313J	A1
LF3316	A299E
LF3318	AR29SP
LF3319	PM1878100752
LF3321	A67SP
LF3322	PM0011843925
LF3325	A116SP
LF3326	A777CSP
LF3326	A777SP
LF3327	PM4031840025
LF3328	A9N6007SP
LF3333	A116SP
LF3333	A3612ASP
LF3333SC	A010
LF3333SC	A105SP
LF3334	A113
LF3335	A14302PLUS
LF3335	A14302PLUS
LF3335	A223
LF3336	A4044
LF3336	AR9
LF3338	A18
LF3338	A18PLUS
LF3339	A243
LF3341	A20
LF3341	A20PLUS
LF3342	A9N5570SP
LF3344	A134
LF3345	A427SP
LF3346	A349SP
LF3346	A349SP
LF3347	A22SP
LF3349	A339SP
LF3353	A1
LF3353	A1SP
LF3357	PM17
LF3360	A343
LF3361	A73
LF3362	A7223SP
LF3363SC	A010
LF3363SC	A105SP
LF3364	PM3
LF3369	A091AE
LF3369	A4046
LF3371	A4052SP
LF3374	A69SP
LF3378	A7028SP
LF3379	A67SP
LF3380	A116SP
LF3383	PM9885132652
LF3391	PM17
LF3401	A1
LF3401	A1SP
LF3403	A323
LF3403	A3603
LF3403	A3603PLUS
LF3407	A2863SP
LF3410	A777CSP
LF3410	A777SP
LF3415	A16242SP
LF3418	A1
LF3420	A299E
LF3422	PM9885132652

FLEETGUARD	PARTMO
LF3424	PM1878100752
LF3432	PM54236E
LF3433	A350
LF3433	A4731SP
LF3434	A113
LF3436	A9003SP
LF3443	A840SP
LF3447	PM53103E
LF3449	A267
LF3453	A116SP
LF3455	A309SP
LF3460	A14302PLUS
LF3462	A323
LF3462	A53
LF3462	A53PLUS
LF3464	A447
LF3470	A205SP
LF3474	A267
LF3476	A67SP
LF3477	A67SP
LF3478	A205SP
LF3480	A232SP
LF3481	A232SP
LF3482	A325SP
LF3486	A4011
LF3488	A1428
LF3489	A267
LF3494	A4044
LF3495	A14476
LF3499	A14302PLUS
LF350	A1
LF3501	A20
LF3501	A20PLUS
LF3505	A267
LF3508	A142SP
LF3509	A14302PLUS
LF3511	PM1650
LF3521	PM313
LF3522	A4051SP
LF3523	A4052SP
LF3524	A291
LF3528	A2863SP
LF3529	PM197
LF3530	A1
LF3530	A1SP
LF3532	A16242SP
LF3536	A323
LF3537	A1402
LF3537	A1402PLUS
LF3541	A010
LF3541	A105SP
LF3542	A777CSP
LF3542	A777SP
LF3543	A494E
LF3545	A777CSP
LF3545	A777SP
LF3547	A9N6007SP
LF3550	A113
LF3552	A339SP
LF3553	A427SP
LF3554	A4011
LF3559	A299E
LF3560	A299E

FLEETGUARD	PARTMO
LF3563	A50
LF3564	A092SP
LF3564	A28SP
LF3564H125	A092SP
LF3568	A178PLUS
LF3568	A243
LF3575	A22SP
LF3583	A232SP
LF3584	PP50361
LF3586	A1403SP
LF3587	A9N6007SP
LF3588	A9N6007SP
LF3589	A777CSP
LF3589	A777SP
LF3590	A494E
LF3598	PM4031840025
LF3599	A113
LF3600	A091AE
LF3604	A20
LF3604	A20PLUS
LF3604	AR1218
LF3608	A7029SP
LF3608	A7029SP
LF3608	A7029SP
LF3614	A14476
LF3614	A14476PLUS
LF3614	A14478PLUS
LF3615	A1406
LF3615	A1406PLUS
LF3615	A14476
LF3617	A1432
LF3618	A7105SP
LF3618	A7105SP
LF3620	A495SP
LF3622	A7041SP
LF3622	A205SP
LF3622SC	A7041SP
LF3624	A4044
LF3626	A205SP
LF3630	A3786SP
LF3633	A350
LF3635	A777CSP
LF3635	A777SP
LF3639	A3000SP
LF3639	A3000SP
LF3640	A408SP
LF3644	A1402
LF3644	A1402PLUS
LF3644	A4044
LF3646	A323
LF3647	A091AE
LF3649	A1402
LF3649	A1402PLUS
LF3649	A4044
LF3652	A7018
LF3654	A7685SP
LF3656	A349SP
LF3657	A323
LF3657	A4044
LF3664	A7223SP
LF3665	A4048SP
LF3666	A4048SP
LF3669	A4049SP

FLEETGUARD	PARTMO
LF3671	A495SP
LF3675	A67SP
LF3677	A3000SP
LF3679	A1428
LF3681	A329
LF3684	A1403SP
LF3687	A840SP
LF3689	A1480
LF3690	A14302PLUS
LF3690	A14302PLUS
LF3690	A223
LF3691	A1402
LF3691	A1402PLUS
LF3692	A58
LF3692	A58PLUS
LF3692	A58T
LF3703	A7125
LF3707	A323
LF3710	PM7572
LF3714	A73
LF3758	AR1218
LF3766	A178PLUS
LF3766	A18
LF3766	A18PLUS
LF3769	PP7196
LF3783	A7133
LF3786	A2863SP
LF3786	A350
LF3788	A54SP
LF3801	PM1650
LF3805	A427SP
LF3806	A339SP
LF3807	A2700SP
LF3807	A2700SP
LF3817	A7028SP
LF3818	A7105SP
LF3827	PP7199
LF3829	PP12140
LF3830	A7028SP
LF3845	A4271SP
LF3845	A4271SP
LF3849	A91480
LF3850	A205SP
LF3854	A2700SP
LF3854	A2700SP
LF3857	A4271SP
LF3857	A4271SP
LF3861	A48SP
LF3862	A1402
LF3862	A1402PLUS
LF3874	A14302PLUS
LF3879	A1402
LF3879	A1402PLUS
LF3883	A408SP
LF3885	A339SP
LF3886	A7898SP
LF3894	A339SP
LF3914	PP9452
LF3919	A299E
LF3921	A339SP
LF3922	A427SP
LF3925	A58
LF3932	A840SP

FLEETGUARD	PARTMO
LF3935	A339SP
LF3945	A1432
LF3959	A339SP
LF3960	A73
LF3970	A7177SP
LF3972	A339SP
LF3974	A3786SP
LF3996	A4044
LF3997	PP7181
LF4006	A67SP
LF4014	A18
LF4014	A18PLUS
LF4015	A7028SP
LF4017	A48SP
LF4053	PM4031840025
LF4054	A840SP
LF4055	A22SP
LF4104	A349SP
LF42501	A111
LF42503	A4011
LF503	PM192
LF504	PM17
LF509	PM197
LF509AN	PM197
LF509N	PM197
LF511	PM197
LF512	PM174
LF516	PM343
LF534	A7105SP
LF551	A1
LF551	A1SP
LF551A	A1
LF551A	A1SP
LF552	PM245
LF560	PM210
LF565	PM210
LF566	PM126
LF568	PM210
LF572	PM17
LF574	PM3
LF583	A11
LF583	A12
LF596	PM813
LF598	PM313
LF607	A50
LF613	PM248
LF621	PM1878100270
LF621	PM3
LF647	A33
LF651	A11
LF653	A11
LF653	A1428
LF654	A54SP
LF655	A113
LF667	A67SP
LF670	A116SP
LF670SC	A116CSP
LF673	A48SP
LF678	A26SP
LF678	A26SP
LF680	AR29SP
LF681	A54SP
LF682	A267

CRUCE DE REFERENCIAS

FLEETGUARD	PARTMO
LF6886	A7898SP
LF689	A20
LF689	A20PLUS
LF690	A48SP
LF691	A69SP
LF691A	A69SP
LF692	A84SP
LF699	AR17
LF702	A129SP
LF711	A111
LF715	A111
LF716	A73
LF716	A73PLUS
LF719	A299E
LF720	PM1878100752
LF734	A205SP
LF742	A7028SP
LF744	A299E
LF747	A116SP
LF750	PMX750R
LF750A	PMX750R
LF750C	PMX750R
LF750D	PMX750R
LF750F	PMX750R
LF757	AR29SP
LF766	A9N5570SP
LF777	A777CSP
LF777	A777SP
LF777A	A777CSP
LF777A	A777SP
LF777X	A777CSP
LF777X	A777SP
LF780	A111
LF780	A43S
LF781	A113
LF782	A4011
LF785	A178PLUS
LF787	AR17
LF789	PMX1878100501
LF793	PM174
LF795	AR9
LF797	A840SP
LF798	A4044
LF9000	A9080SP
LF9001	A9080SP
LF9009	A3000SP
LF9009	A3000SP
LF9011	A9080SP
LF9018	A9080SP
LF9025	A9025SP
LF9027	A3786SP
LF9031	A9080SP
LF9035	A9035SP
LF9070	A9080SP
LF9080	A9080SP
LF9098	A339SP
LF9100	A427SP
LF9325	A3612ASP
LF9333	A116SP
LF9620	A495SP
LF9667	A67SP
LF9747	A116SP
LFP5822	A160

FLEETGUARD	PARTMO
MK01496	A3612ASP
MK0151300	A15
MK1104000	A3612ASP
MK11117	A15
MK11140	A15
MK1114000	A15
MK11275	A3612ASP
MK1128000	A3612ASP
MK11309	A3612ASP
MK11428	A3612ASP
MK11510	A3612ASP
MK11518	A495SP
MK11600	A495SP
MK11660	A495SP
MK11661	A495SP
MK11740	A3612ASP
MK12337	A495SP
MK12405	A1226
MK12406	A614
MK12407	A15
MK12409	A3612ASP
MK12429	A614
MK13050	PM19624SP
MK13051	PP7230SP
MK13051	PP7761
MK13067	PM19624SP
MK13068	PP7230SP
MK13071	A7685SP
MK13084	PM19624SP
MK13095	PM19624SP
MK13097	A614
MK13103	A1P2299
MK13103	A1P2299
MK13113	A7685SP
MK13119	A7685SP
MK13121	A7301DSP
MK13126	PP7230SP
MK13126	PP7761
MK13128	PP7230SP
MK13128	PP7761
MK13148	PM19624SP
MK13150	PM19624SP
MK13151	PM19624SP
MK13158	PM19624SP
MK13158	PP7230SP
MK13158	PP7761
MK13159	PM19624SP
MK13160	PP7230SP
MK13160	PP7761
MK13169	PP7230SP
MK13170	PP7230SP
MK13199	A7766SP
MK13409	PM19624SP
MK13883	A9080SP
MK1389	A15
MK1396KIT	A3612ASP
MK1398	A3612ASP
MK145100	A3612ASP
MK1460	A15
MK1483	A15
MK1496	A3612ASP
MK1514	A15
MK196	A15

FLEETGUARD	PARTMO
MK210D	A3612ASP
PA2140	AP4041
ST6065	A83910
W81480	A3000SP
WF2004	AW5137SP
WF2010	AW5137SP
WF2011	AW2022SP
WF2012	AW2010SP
WF2013	AW2016SP
WF2014	AW2016SP
WF2015	AW475SP
WF2016	AW2010SP
WF2022	AW2022SP
WF2023	AW5137SP
WF2050	AW2022SP
WF2051	AW5137SP
WF2053	AW2010SP
WF2054	AW2016SP
WF2055	AW2016SP
WF2056	AW2016SP
WF2059	AW2010SP
WF2059	AW5137SP
WF2060	AW2010SP
WF2061	AW2010SP
WF2066	AW2016SP
WF2067	AW2016SP
WF2067	AW5137SP
WF2069	AW5137SP
WF2071	AW5137SP
WF2073	AW2010SP
WF2081	AW2010SP
WF2082	AW2022SP
WF2083	AW475SP
WF2088	AW5137SP
WF2089	AW2016SP
WF2096	AW2237SP
WF2123	AW2010SP
WF2126	AW2127SP
WF2127	AW2127SP
WF2142	AW2010SP
WF2144	AW2010SP
WF2144	AW2016SP
WF2152	AW5137SP
WF2175	AW5137SP
WF4013	AW2016SP
XLF5000	A495SP
XLF7000	A3000SP
FRAM	PARTMO
5342	PM17
273716	AR29SP
509812	AR29SP
513153	A91T1
P10503	A1006SP
BC175T	PMX750R
BCH211	PM343
BCH33APL	PM197
BF6T9601AA	AP17308
BPH13	A11
BPH13A	A11
BPH13A	A12
BPH30	A11
BPH30	A12
BPH373	A84SP

FRAM	PARTMO
BPH43	A20
BPH43	A20PLUS
BPH49A	A67SP
BPH6349	A3000SP
BPH6349	A3000SP
BPH8A	A1
BPH8A	A1SP
C1108PL	PM192
C1109	PP246
C11819PL	PM28S1Z
C11832PL	PM707
C11832PL	PM707E
C11860	PM324
C11860	PM324E
C118601	PM707
C118601	PM707E
C11860P1	PM707
C11860P1	PM707E
C11860PB	PM707
C11860PB	PM707E
C11860PL	PM707
C11860PL	PM707E
C11860Z	PM324
C11860Z	PM324E
C11861	PM28S1Z
C11861	PM325
C118611	PM28S1Z
C11861P1	PM28S1Z
C11861PB	PM28S1Z
C11861PL	PM28S1Z
C11863Z	PM325
C11864Z	PM324
C11864Z	PM324E
C11868PB	PM707
C11868PB	PM707E
C11868PL	PM707
C11868PL	PM707E
C118PL	PM192
C1191	P346P
C1191A	P346P
C1191PL	P346P
C1194	PM9760
C121E	A1480
C123E	A339SP
C127	A7105SP
C127	A7105SP
C130	PM210
C134A	PM210
C134PL	PM210
C153	PM3
C1680	AR29SP
C1690	PM192
C175	PMX750R
C175A	PMX750R
C175E	PMX750R
C175T	PMX750R
C180	PM3
C184	PM17
C1860Z	PM324
C1860Z	PM324E
C231PL	PM1878100270
C232PL	PM210
C2883	PM4031840025

FRAM	PARTMO
C2926	PM0011843925
C298	AS1040SP
C3	PM3
C30	PM17
C301	PM17
C30DB	PM17
C30P	PM17
C30PL	PM17
C31	PM17
C31P	PM17
C31PL	PM17
C363	PMX1878100501
C3P	PM3
C4104	PM9885111911
C4109	PM28S1Z
C4147	PM1878100270
C4147	PM1878100271
C4155	P346P
C4161	P3461
C4163	P3461
C4454	PM324
C4454	PM324E
C4616	PM313
C4661	P3461
C4661A	P3461
C4713	PM9760
C5582	P596
C5932	PP7761
C7042	PM192
C7519	PM9885111911
C8017	PM7680
C8268	PM1878100271
C827	PM3
C833PL	PM126
C842	PM3
C8662	PM7680
C870	PM126
C870PL	PM126
C873	PM17
C8731	PM17
C8763	PM9M9740
C8826	PP7735
C891	PM3
C9262	PP7735
C9559	PP7761
C9562	PP7735
C9771	PP246
C988	PM3
C988C	PM3
CA10029	APC23610
CA10086	AP3108
CA10088	AP29400
CA10093	AP3571
CA10110	AP31942
CA10115	AP3191
CA10118	AP35741
CA10173	AP35602
CA10190	AP31801
CA10191	AP35961
CA10193	AP3450
CA10234	AP3132
CA10271	AP3122
CA10305	AP4862

FRAM	PARTMO
CA10305SY	AP4863
CA10330	AP3570
CA10330	AP35756
CA10334	AP35247
CA10343	AP31753
CA10348	AP31795
CA10470	AP3144
CA10497	AP31788
CA10498	AP35939
CA10500	AP355344
CA10516	AP35783
CA10616	AP23603
CA10630	AP3120
CA10696	AP35781
CA10697	AP35781
CA10699	AP31744
CA10755	AP35898
CA10839	AP31928
CA10879	AP3537
CA10891	AP35960
CA10910	AP31950
CA10997	AP35844
CA11114	AP35893
CA11170	AP35932
CA11222	AP350990
CA11241	AP3113
CA11259	AP31899
CA11480	AP31992
CA11500	AP31900
CA11895	AP31500
CA12057	AP311033
CA12065	AP31980
CA12088	AP311019
CA12260	AP99727
CA1462	AP46530
CA1550	AP57MD21
CA1550	AP57MD31
CA1551	AP57MD21
CA1574	AP2425
CA1580	AP2520
CA1580	AP2520H
CA1580ASY	AP2521
CA1580SY	AP2521
CA1581	AP117797
CA1582	AP2482
CA1588	AP46530
CA1588SY	AP46531
CA1591	AP95600906
CA1596	AP182028
CA1596ASY	AP137640
CA1596SY	AP137640
CA184	AP127
CA188PL	AP6261
CA201CD1	A83910
CA216	AP4M9378
CA224	AP4M8047
CA226	AP4M9334
CA227	AP4337
CA235	AP4M9379
CA236	AP33
CA236	AP4M9335
CA237	AP4M8048
CA2523SY	AP87658

FRAM	PARTMO
CA253	AP101222K
CA253SY	AP2489
CA254	AP101234K
CA2541SY	AP127313
CA2548	AP812105
CA2548SY	AP114215145
CA2555	AP127312
CA2556	AP25867
CA2556SY	AP87658
CA2557SY	AP2489
CA256	AP101275K
CA2576	AP2576
CA2577	AP2576
CA2577	AP2577
CA258	AP101246K
CA2582SY	AP25867SY
CA2586	AP95600906
CA2592	AP7N1225
CA2621	AP25867SY
CA2663	APR12
CA2740	AP626
CA2778	APR9
CA282A	AP101246K
CA283A	AP17308
CA283APU	AP17308
CA3243	AP16546
CA3245	AP16546
CA3256	AP2825
CA326	AP121
CA3261	AP101234K
CA328	AP6261
CA3280	AP2291
CA3280SY	AP4091
CA3281	APC203252
CA3281SY	APC203252SY
CA3281SYCDN	APC203252SY
CA3290	AP2291
CA3290A	AP2291
CA3291	APC203252
CA3291ASY	APC203252SY
CA3291SY	APC203252SY
CA338	AP3129
CA3490	AP4337
CA3523	AP147
CA3524	AP626
CA3588	AP126
CA3588	AP2300
CA3681	AP121
CA3750	AP2705
CA376	AP1861
CA3782	AP2216
CA3782SY	AP4416
CA3794	AP117797
CA3824	AP2632
CA3901	AP1323
CA3913	AP2660
CA3918	AP3119
CA3924	AP3924
CA3989	AP2621
CA3989SY	AP2621
CA3990	AP2705
CA3998	AP142
CA4309	AP1312

FRAM	PARTMO
CA4320	AP323
CA4342	AP101246K
CA4343	AP812105
CA4347	AP1861
CA4361	APSL5013Z40A
CA4376	AP46530
CA4383	AP603A
CA4576	AP35645
CA4580	AP1368
CA4594	AP3709
CA4645	AP35815
CA4778	AP31550
CA4818	AP1861
CA4924	AP3533
CA4938	AP531
CA4939	AP3179
CA4940	AP3124
CA4979	AP410
CA502	APCA502
CA5021	AP5021
CA5021SY	AP51250
CA5023SY	APCA502SY
CA5028	AP101246K
CA502SY	APCA502SY
CA5034	AP121
CA5058	AP3562
CA507	AP110558
CA5070	AP2712
CA5070	AP2712A
CA507SY	AP106775
CA5109	AP1347
CA5111	AP3517
CA5125	AP3142
CA5140	AP1275
CA523AY	AP4129908
CA523SY	AP4129908
CA530	AP35815
CA5304	AP2884
CA5308	AP1087
CA5344	AP35644
CA5350	AP35644
CA5370	AP3527
CA53777	AP2021
CA53777	AP2021
CA5445	AP35606
CA5447	AP31585
CA5463	AP1294
CA5466	AP3133
CA5468	AP35733
CA5496	AP1298
CA5505	AP31528
CA5506	AP3118
CA5527	AP31592
CA5560	AP35590
CA559	AP110558
CA5595	AP31521
CA5626PU	AP5627
CA5626PU	AP5628
CA5626SYPU	AP5628
CA568	AP4041
CA5682	AP1330
CA5687	AP3176
CA5741	AP3544P

FRAM	PARTMO
CA5741SP	AP3545
CA5741SY	AP3545
CA5745	AP3542
CA5745SY	AP3543
CA5771	AP2825
CA5787	AP1908233
CA5876	AP3570
CA589	AP101246K
CA5945	AP31542
CA595	AP57MD33
CA597	AP117797
CA6152	AP2680
CA6318	APCA502SY
CA6324	AP2688
CA6362	AP3932
CA6366	AP1305
CA6369	AP146
CA6375	AP132
CA6376	AP561
CA6377	AP3119
CA6379	AP1312
CA6387	AP1368
CA6395	AP3129
CA6481	AP2677
CA6512	AP2680
CA6530	AP1861
CA6541	AP1330
CA6544	AP31555
CA6545	AP35815
CA6548	AP31550
CA6664	AP31511
CA6690	AP3568
CA6696	AP2761
CA6828	AP31559
CA6828	AP3509
CA6850	AP31544
CA6858	AP2805
CA70	AP3709
CA7074	AP2761
CA70PL	AP3709
CA70PLA	AP3709
CA7139	AP2863
CA7139SY	AP3501
CA7139SYBLK	AP3501
CA7140	AP3518
CA7140SY	AP3518SY
CA7142	AP311002
CA7142	AP3118
CA7167	AP3123
CA7174	AP3137
CA7344	AP3138
CA7351	AP3135
CA7417	AP3170
CA7421	AP1339
CA7422	AP524344
CA7440	AP3574
CA7453	AP2712
CA7453	AP2712A
CA7465	AP4129907
CA7466	AP2654
CA7466BLK	AP2654
CA7605	AP31531
CA7614	AP35793

FRAM	PARTMO
CA7626	AP3136
CA7630	AP31564
CA7669	AP3582
CA7674	AP2761
CA7695	AP2863
CA7730	AP6261
CA7764	AP1292
CA7775	AP1375
CA8004	AP3515
CA8029SY	AP821884
CA8037	AP3707
CA8038	AP3707
CA8039	AP3515
CA8052	AP3176
CA8067	AP3170
CA8121	AP3121
CA8133	AP3139
CA8162	AP3567
CA8180	AP3539
CA8193	AP2690
CA8197SY	AP3501
CA8205	AP1323
CA8208	AP3128
CA8227	AP3518
CA8229	AP3722
CA8243	AP1365
CA8244	AP14210
CA8245	AP14220
CA8248	APC203252SY
CA8297SY	AP3545
CA8304	APC203252
CA8305SY	APC203252SY
CA8308	AP3544P
CA8466	AP3548
CA8473	AP3139
CA8511SY	AP2654SY
CA8548	AP3581
CA8601	AP35606
CA8602	AP35591
CA8602	AP35665
CA8609	AP1339
CA8636	AP3134
CA8659	AP2690
CA8674	AP3578
CA8730	AP31542
CA8734	AP2510
CA8737	AP3544P
CA8737SY	AP3545
CA8766	AP31678
CA8766	AP35790
CA87932	AP3936
CA8918	AP3134
CA8919	AP35594
CA8922	AP3140
CA8929	AP3565
CA8932	AP3936
CA8997	AP3557
CA9003	AP3920
CA9015	AP35607
CA9033	AP20457
CA9074	AP0978
CA9115	AP31653
CA9244	AP3736

FRAM	PARTMO
CA9244SY	AP3737
CA9245	AP7242
CA9246	AP3988
CA9250	AP17845
CA9269	AP3542
CA9269SY	AP3543
CA9277	APSL40A
CA9300	AP537
CA9308	AP35553
CA9332	AP35736
CA9345	AP35433
CA9346	AP4636
CA9346SY	AP4637
CA9352	APC20500
CA9355	AP72152
CA9359	AP3125
CA9367	AP31624
CA9410	AP35786
CA9418	AP72152
CA9418SY	AP72154
CA9440	AP16550
CA9482	AP31628
CA9483	AP3511
CA9493	AP63680
CA9515	APG4800
CA9546	APC23610
CA9563	AP1365
CA9591	AP4001
CA9669	AP31834
CA9683	AP3116
CA9687	AP35755
CA9744	AP3920
CA9746	APC23610
CA9746SY	APC23610SY
CA9747	AP84457
CA9754	AP3561
CA9833	AP3536
CA9856	AP2877S
CA9872	AP2291
CA9872SY	AP4091
CA9894	AP3111
CA9902	AP3196
CA9937	AP4439
CA9959	AP3513
CAF7798	AP31035
CAK1532	AP2360
CAK1563	AP101275K
CAK1567	AP101234K
CAK2523	AP25867
CAK2523SY	AP87658
CAK253	AP101222K
CAK254	AP101234K
CAK2557	AP4000
CAK256	AP101275K
CAK258	AP101246K
CAK258	AP4M9335
CAK3193	AP3193
CAK3450	AP3500
CAK4328	AP101222K
CAK4350	AP3500
CAK4361	APSL5013Z40A
CAK4413	AP101246K
CAK4414	AP25867

FRAM	PARTMO
CAK4928	AP2360
CAK5047S	AP101222K
CAK5048S	AP101234K
CAK6916	APSL5013Z40A
CAK8390	AP101246K
CF10210	AP31739
CF10285	AP31071
CF10545	AP31088
CF10553	AP31060
CF10627	AP31743
CF10731	AP31026
CF11176	AP31032
CF11184	AP31054
CF11819	AP31029
CF11854	AP31097
CF11902	AP31631
CFA10435	AP33893
CG5	PM210
CG807	PM988511911
CH10066	PP358
CH10075ECO	PP1053
CH10076ECO	PP62442
CH10158	PP31060
CH10246	PP85674
CH10295	PP7406
CH10358	PP4024
CH10473ECO	PP27401
CH10649	PP7199
CH10670ECO	PP3C30A
CH10759	PP15562
CH10955	PP79744
CH11276ECO	PP2F000
CH11860PL	PM707
CH11860PL	PM707E
CH12069	PP80215
CH12246	PP95785
CH12767	AP101275K
CH129PL	PM174
CH155PL	PM9M9740
CH211	PM343
CH211A	PM343
CH236APL	PM210
CH2821A	PM248
CH2821B	PM248
CH2829	PM4031840025
CH2832	PM126
CH2833	A14302PLUS
CH2844	A14302PLUS
CH28501	PM126
CH28502	PM126
CH2865	PM9885132652
CH2869	PM210
CH2870A	A178PLUS
CH2871	A323
CH2872	A113
CH2877	PM1878100752
CH2880	PM313
CH2902	PM1878100752
CH2927A	PM0011843925
CH2929	PM4031840025
CH2962	PM4031840025
CH2991	A14302PLUS
CH330PL	PM245

FRAM	PARTMO
CH33APL	PM197
CH33PL	PM197
CH33PL1	PM197
CH3505	PM1878100752
CH3543	PM197
CH4536	PP50361
CH5958	PP92425
CH6068	A243
CH6848	PP40425
CH6PL	PM174
CH7504	PM126
CH7704	PM1878100752
CH7707	PM4031840025
CH8081	PP27908
CH813	PM813
CH813PL	PM813
CH815PL	PM126
CH815PL1	PM126
CH8193	AP2690
CH820PL	PM126
CH820PLB	PM126
CH828PC	PM126
CH828PL	PM126
CH831PL	PM248
CH834	PM313
CH834PL	PM313
CH834PL1	PM313
CH834PL11	PM313
CH836PL	PM313
CH841PL	PM126
CH8481	PP7181
CH8530	PP5562
CH8751	PP7199
CH8871	PP7196
CH8PL	PM192
CH9018	PP8088
CH913PL	PM813
CH921PL	PM813
CH922PL	PM126
CH9260	PP9452
CH9461	PP15466
CH9461	PP4780
CH9463	PP15466
CH9558	PP7230SP
CH958PL	PM313
CH9641	PP6
CH9685ECO	PP27000
CH9911	PP7399
CH9999	PP57061
CHW33PL	PM197
CS12133	PP71044
CS3504	PP202030
CS3558	PP204030
CS5043	PP201010
CS5043	PP201030
CS5403	PP201010
CS7772A	PM7680
CS7772B	PM7680
CS8323	PP7751
CS8744	PM19624SP
CS8744A	PM19624SP
CS8941	PP7777SP
CS9245	AP7242

FRAM	PARTMO
CS9970	PP19684SP
CV12058	AP31043
CV12157	AP31138
CV12160	AP43100
D326	AP121
DG13	A11
DG2	A329
DG25	A33
DG2849A	A73
DG2870A	A178PLUS
DG2951	A113
DG30	A11
DG30	A12
DG3387A	A111
DG3593A	A323
DG3600	A243
DG3614	A14302PLUS
DG3675	A1432
DG3682	A113
DG3950	A4044
DG3980	A4011
DG3985	A4044
DG43	A20
DG43	A20PLUS
DG4967	A14476
DG4967	A14476PLUS
DG5	A1428
DG6607	A58
DG7317	A1402
DG8A	A1
DG8A	A1SP
F175P	PMX750R
F175PW	PMX750R
F3	PM3
F30	PM17
F30P	PM17
F30SERIES	PM17
F31	PM17
F36	PM17
F3P	PM3
F3SERIES	PM3
F475P	PMX750R
F8PLOE	PM192
FA1549	AP57MD31
FA154910E	AP57MD31
FA154920E	AP57MD31
FA1580	AP2520
FA158010E	AP2520
FA158010E	AP2520
FA158020E	AP2520
FA158020E	AP2520
FA1580SERIES	AP2520
FA1581	AP117797
FA158110E	AP117797
FA158110E	AP117797
FA1581SERIES	AP117797
FA1582	AP2482
FA158210E	AP2482
FA158210E	AP2482
FA1582SERIES	AP2482
FA15911	AP95600906
FA159110E	AP95600906
FA159110E	AP95600906

FRAM	PARTMO
FA1591SERIES	AP95600906
FA1596	AP137640
FA1596	AP182028
FA15961	AP182028
FA159610E	AP182028
FA159610E	AP182028
FA15962	AP137640
FA15962	AP182028
FA159620E	AP137640
FA1596SERIES	AP182028
FA2576	AP2576
FA25760E	AP2576
FA5412ECO	PP5562
FA595	AP57MD33
FA59510E	AP57MD33
FA59510E	AP57MD33
FA595SERIES	AP57MD33
FA701PL	AP3709
FA701PLHD	AP3709
FA70PL	AP3709
FA70PLOE	AP3709
FH33PL	PM197
FH33PLOE	PM197
FH6PL	PM174
FH6PLOE	PM174
FH8PL	PM192
FH8PLOE	PM192
FHB16PL	PM192
FHB6PL	PM174
FK3904	A15
FK9295	AP31037
FLIOT6905ANM	AP3542
FLIOT6926ANM	AP3544P
FLIOT6927ANM	AP3545
FLIOT6928ANM	AP3543
FPCF10719	AP31043
G10166	PFG7802
G10M	PFG516K
G10MDP	PFG516K
G12	PFG516K
G121	PFG516K
G12DP	PFG516K
G2	PFG516K
G21	PFG516K
G2DP	PFG516K
G2S	PFG516K
G3	PFG323
G3606	PFG516K
G3606DP	PFG516K
G3703	PFG805
G3703DP	PFG805
G3742	PFG1105
G3802	PFG1105
G3802A	PFG1105
G3802ADP	PFG1105
G3802AFP	PFG1105
G3802DP	PFG1105
G3829	PFG1195
G3829DP	PFG1195
G3850	PFG872
G3850DP	PFG872
G4164	PFG516K
G4169	PFG516K

FRAM	PARTMO
G4177	PFG805
G4177DP	PFG805
G4191	PFG805
G4191DP	PFG805
G4194	PFG1105
G4777	PFG1104
G4894	PFG1105
G5237	PFG1163
G5237DP	PFG1163
G5441	PFG368
G5540	PFG25121074
G5540	PFG330
G5561	PFG3191125000
G5603	PFG1196
G5857	PFG3191125000
G5857	PFG405
G5870	PFG323
G5915	PFG4811
G5978	PFG25121074
G5982	PFG368
G6411	PFG516K
G6424	PFG516K
G6426	PFG805
G6426DP	PFG805
G6453	PFG44781
G6459	PFG44781
G6459DP	PFG44781
G6469	PFG1191
G6680	PFG423
G6680DP	PFG423
G6825	PFG423
G6901	PFG4811
G7143	PFG330
G7393	PFG1104
G7396	PFG335
G7404	PFG1105
G7418	PFG0120490B
G7729	PFG1400
G8174	PFG516K
G8758	PFG1105
G9343	PFG7742
G9839	PFG25121074
GF613	PFG4811
GH140	PM174
GH160	PM3
GH230	A1
HCA1550	AP57MD31
HCA1551	AP57MD21
HCA2576	AP2576
HCA595	AP57MD33
HCAK1532	AP2360
HCAK253	AP101222K
HPH11000FP	A3000SP
HPH3335	A69SP
HPH3612	A116SP
HPH3612FP	A116SP
HPH3649	A3000SP
HPH3690	A2700SP
HPH3690	A2700SP
HPH3690	A7041SP
HPH3690	A7041SP
HPH3690FP	A7041SP
HPH3766	A134

FRAM	PARTMO
HPH6349	A3000SP
HPH6349	A3000SP
HPH6349A	A3000SP
HPH6349A	A3000SP
HPH6349AFP	A3000SP
HPH7405	A495SP
HPH9500	A3000SP
HPH9500	A3000SP
HPH9617FP	A7898SP
K3926	A106
K3926	A1212SP
K3926	ASV1212SP
KPB50	A50
LA3583	AP7242P
LF35K1	A292
LF3617	A1432
LF568	PM210
LF67K	A034L
LF67K	A4053SP
LF67K	A5138SP
LFP815FN	A96
LFP816FN	A97
LO2205K	A1403SP
LO6205	PM7572
LO729K	A4049SP
LX526	AP35590
P10503	A1006SP
P10715	A7813SP
P1101A	A15
P1101PL	A15
P1102	A1212SP
P1103	A1212SP
P1103	ASV1212SP
P1103A	A1212SP
P1104	A1P2299
P1104	A1P2299
P1105	AR16SP
P1107	A1212SP
P1108	A46SP
P1108	A46SP
P1108	A888
P1109	A31SP
P1109	A31SP
P1110	A30SP
P1110	A30SP
P1112	A1212SP
P1118	A23L39
P1118	A23L39SP
P1121	A588
P1121	A588SP
P11238	PFG454
P1126	A43SP
P1129	A1226LSP
P1146	A96
P1146G	A96
P1146GFP	A96
P1147	A97
P1147	A97SP
P1147A	A97
P1147A	A97SP
P1147G	A97
P1147G	A97SP
P1147GFP	A97

FRAM	PARTMO
P1147GFP	A97SP
P1633A	A83910
P1653	A83910
P16534AGL	A83910
P16534AGR	A83910
P1653A	A83910
P1653A1	A83910
P1653V15A	A83910
P1653VI5A	A83910
P1654V51A	A83910
P1654V52A	A83910
P1654V53A	A83910
P1654V54A	A83910
P1655	A54SP
P16551A	A54SP
P16552A	A54SP
P16553A	A54SP
P16554A	A54SP
P2805	A50
P2806	A50
P2808	A50
P2814	A178PLUS
P29130	AP101222K
P29195	AP101246K
P31488	AP2291
P3375	A614
P3376	A85
P3380	A588
P3380	A588SP
P3380FP	A588
P3380FP	A588SP
P3383	AW2022SP
P3401	A43SP
P3401	A787
P3431	A150F
P3431	A150F
P3431FP	A150F
P3431FP	A150F
P3432	A33
P3509	A83910
P3528	A23
P3528	A23SP
P3528A	A23
P3528A	A23SP
P3528AFP	A23
P3528AFP	A23SP
P3555	A777CSP
P3555	A777SP
P3555A6	A777CSP
P3555A6	A777SP
P3555A	A777CSP
P3555A	A777SP
P3555PL	A777CSP
P3555PL	A777SP
P3594	A96C
P3595	A97C
P3627	A4053SP
P3645	A96C
P3658	A4053SP
P3710	A1285DSP
P3726	A305F
P3726	A3726
P3726	A3726SP

FRAM	PARTMO
P3759	A70015SP
P3767	A588C
P3772	A91T1
P3780	A91T1
P3780	AR29SP
P3788	A330C
P3823	A97
P3823	A97SP
P3828	A4052SP
P3951	A354
P3952	A354
P4005	A4886
P4102	A243004
P4102	A243004SP
P4102	A33358
P4102A	A243004
P4102A	A33358
P4102PL	A243004
P4102PL	A33358
P4102RP	A243004
P4102RP	A33358
P4104	A1
P4105	A4618310
P4139	A330C
P4139PL	A7602
P4139RP	A330C
P4140	A4618310
P4157	A1226LSP
P4157	A33358
P4157	A33358L
P4174	PGF516K
P4178	A4053SP
P4178A	A4053SP
P4179	A305F
P4179	A3726
P4183	A1226LSP
P4473	A243004
P4473	A33358
P449A	A67SP
P4529	A267
P4530	A4053SP
P4587	A1226LSP
P4637	A4863
P4637A	A4863
P4638	A354
P4687	A43SP
P4688	A33358
P4766	A4047
P4886	A4886
P4922	A7533DSP
P4922	A7533SP
P5068	A54SP
P5138	A7533SP
P5423	A494E
P5457	A1226LSP
P5457	A33358
P5465	A777CSP
P5465	A777SP
P5469	A4863
P5537	A1226LSP
P5694	A7653
P5770	A243004
P5786	A777CSP

FRAM	PARTMO
P5786	A777SP
P6904	A7602
P7037	A83910
P7040	A91T1
P7046	A91T1
P7053	A840SP
P7153	A330C
P7153	A941C
P7153	A941SP
P7164	A15
P7251	A23
P7307	A70015SP
P7357	A1212SP
P7363	A56670
P7402	A1P2299
P7402	A1P2299
P7509	A588
P7510	A243004
P7511	A1226LSP
P7511	A33358
P7514	A4047
P7514BLK	A4047
P7524	A91T1
P7572	A4047
P7700	A7018
P7701	A1226LSP
P7719	A56670
P8021	A69SP
P8032	A330C
P8043	A1226
P8043	A1226LSP
P8043	A243004DSP
P8043	A243004DSP
P8049	A1218
P8049	A7656E
P8050	A7657
P8263	A7602
P8264	A1R0751SP
P8434	A243004
P8434	A33358
P8451	A1R0751SP
P8490	A1R0751SP
P8490	A1R0751SP
P8A	A1
P9072	A7773SP
P9072FP	A7773SP
P9407	A7685SP
P9457	A4053SP
P9458	A4053SP
P961PL	A20
P961PL	A20PLUS
P9626	A8059
P9644	A7766SP
P9805	PGF3191125000
P9865	A70010
PA10181	AP31037
PA10184	AP43042
PA10188	AP31036
PA10336	AP31035
PB50	A50
PB501	A50
PB502	A50
PB55	A50

FRAM	PARTMO
PCS1144	A5813SP
PCS5059	A1212SP
PCS5059	ASV1212SP
PCS5059M	A1212SP
PCS5059M	ASV1212SP
PCS5060	A5813SP
PCS5060G	A5813SP
PCS5062	A1212SP
PCS5062	ASV1212SP
PCS5062M	A1212SP
PCS5063	A1212SP
PF3690	A010
PF3690	A105SP
PF43	A20
PF43	A20PLUS
PF4560	A267
PF9715	A58
PG25	A70010
PG251	A70010
PG3334	A48MC
PG33341	A48MC
PG33342	A48MC
PH1	A1
PH10060	A160
PH10060	A160PLUS
PH10268	A329
PH10401	AL106
PH10575	A52041SP
PH10600	A15403
PH11017	A9035SP
PH12	A1
PH13	A11
PH13A	A11
PH13FP	A11
PH14	A11
PH14	A12
PH16	A20
PH16	A20PLUS
PH16	AR1218
PH16FP	A20
PH16FP	A20PLUS
PH16FP	AR1218
PH181001	AP3707
PH19	A1
PH19	A1SP
PH19A	A1
PH19A	A1SP
PH2	A329
PH20	A26SP
PH20	A26SP
PH20A	A26SP
PH20A	A26SP
PH25	A33
PH2671	A323
PH28	A243
PH2801	A840SP
PH2801A	A840SP
PH2801B	A323
PH2803	A1
PH2806A	A20
PH2806A	A20PLUS
PH2806A	AR1218
PH2807	A20

FRAM	PARTMO
PH2807	A20PLUS
PH2809	A14302PLUS
PH2811	A7028SP
PH2812	A1
PH2816	A20
PH2816	A20PLUS
PH2816	AR1218
PH2821A	A1
PH2821A	A1SP
PH2823	A22SP
PH28231	A20
PH28231	A20PLUS
PH28231	AR1218
PH2824	A22SP
PH2825A	A113
PH2826	A267
PH2827	A1
PH2828	A1
PH2829	A48SP
PH2830	AR1218
PH2833	A7028SP
PH2834	A14302PLUS
PH2836	A48SP
PH2838	A7028SP
PH2842	A840SP
PH2844	A18
PH2844	A18PLUS
PH2849	A73
PH2849A	A73
PH2849A	A73PLUS
PH2853	A20
PH2853	A20PLUS
PH2853	AR1218
PH2854	A14302PLUS
PH2856	A4044
PH2857A	A20
PH2857A	A20PLUS
PH2857A	AR1218
PH2861	A14302PLUS
PH2861A	A14302PLUS
PH2862C	A111
PH2863	A20
PH2863	A20PLUS
PH2863	AR1218
PH28631	A20
PH28631	A20PLUS
PH28631	AR1218
PH2868	A20
PH2868	A20PLUS
PH2868	AR1218
PH2870	A178PLUS
PH2870A	A178PLUS
PH2870B	A178PLUS
PH2871	A323
PH2872	A113
PH2875	A14302PLUS
PH2876	A58
PH2877	A16242SP
PH2879	A1
PH2879	A20
PH2879	A20PLUS
PH2883	A349SP
PH2887	A48SP

FRAM	PARTMO
PH2899	A20
PH2899	A20PLUS
PH28A	A243
PH2901	A091AE
PH2921	A091AE
PH2921	A4046
PH2924	A840SP
PH2926	A243
PH2934	A4011
PH2951	A14302PLUS
PH2951	A14302PLUS
PH2951	A223
PH2951	A4041
PH2951A	A14476
PH2956	A1226LSP
PH2957	A113
PH2957	A178PLUS
PH2964	A14302PLUS
PH2964	A18
PH2964	A18PLUS
PH2968	A840SP
PH2977A	A091AE
PH2977B	A2863B
PH2977B	A2863SP
PH2985	A113
PH2990	A20
PH2990	A20PLUS
PH2990	AR1218
PH2991	A178PLUS
PH2992	A4044
PH2992A	A4044
PH2993	A20
PH2993	A20PLUS
PH2993	AR1218
PH2995	A54SP
PH2996	A1
PH2996A	A1
PH2996A	A1SP
PH2FP	A329
PH3	A1
PH3	A1SP
PH30	A11
PH30	A12
PH30FP	A11
PH30FP	A12
PH32	A1
PH32	A1SP
PH33	A1
PH3306A	A48SP
PH3335	A69SP
PH3335FP	A69SP
PH3354	A111
PH3375	A116SP
PH3381	A1
PH3381	A1SP
PH3387	A111
PH3387A	A111
PH3387A	A4011
PH3387A	A43S
PH3387AFP	A111
PH33PLOE	PM197
PH3416	A129SP
PH3416A	A129SP

FRAM	PARTMO
PH3442	A116CSP
PH34804	A7223SP
PH3509	A1
PH3519	A9N557OSP
PH3519A	A9N557OSP
PH3534	A267
PH3535	A4011
PH3545	A9N6007SP
PH3545FP	A69SP
PH3562	A4044
PH3567	A91T1
PH35671	A91T1
PH3567V151	A91T1
PH3567V15C1	A91T1
PH3567V51	A91T1
PH3567V5C1	A91T1
PH3568	A14476
PH3592	A73
PH3593	A323
PH3593	A323PLUS
PH3593	A52
PH3593	A53PLUS
PH3593A	A323
PH3593AFP	A1402
PH3593AFP	A1402PLUS
PH36	A54SP
PH3600	A243
PH3600A	A243
PH3600FP	A243
PH3612	A116SP
PH3612	A3612ASP
PH3612A	A116SP
PH3612FP	A116SP
PH3612FP	A3612ASP
PH3614	A14302PLUS
PH3614	A14302PLUS
PH3614	A223
PH3614FP	A14302PLUS
PH3635	A4011
PH3664	A4044
PH3675	A1432
PH3682	A113
PH3690	A2700SP
PH36A	A54SP
PH3726	A292
PH373	A84SP
PH3735	A840SP
PH3757	A205SP
PH3766	A134
PH3766FP	A134
PH3776	A840SP
PH3786	A3786SP
PH3786FP	A3786SP
PH38	A48SP
PH3807	A323
PH3809	A091AE
PH3816	A18
PH3816	A18PLUS
PH39	A299E
PH3900	A427SP
PH3917	A73
PH3946	A4044
PH3950	A4044

FRAM	PARTMO
PH3950	AR9
PH3973	A267
PH3976	A339SP
PH3976A	A339SP
PH3976AFP	A339SP
PH3976FP	A339SP
PH3980	A4011
PH3980FP	A4011
PH3985	A1402
PH39FP	A299E
PH40	A299E
PH41	A267
PH43	A20
PH43	A20PLUS
PH4386	A14476PLUS
PH43FP	A20
PH43FP	A20PLUS
PH4467	A267
PH4469	A9N6007SP
PH4478	A14476
PH4511	A160
PH4511	A160PLUS
PH4511	A4051SP
PH4532	A091AE
PH4547	A4044
PH4559	A22SP
PH4560	A267
PH46	A18
PH46	A18PLUS
PH4681	A178PLUS
PH47	AR29SP
PH4703	A4044
PH4703A	A73
PH4722	A111
PH4722A	A111
PH4731	A350
PH4731	A4731SP
PH4733	A113
PH4750	A14302PLUS
PH4798	A447
PH48	A20
PH48	A20PLUS
PH4804	A7223SP
PH4825	A1
PH4826	A091AE
PH4847	A232SP
PH4847A	A232SP
PH4853	A2863SP
PH4853	A350
PH4854	A1
PH4868	A840SP
PH4869	A4051SP
PH4870	A323
PH4872	A4052SP
PH4883	A178PLUS
PH49	A67SP
PH4913	A73
PH4967	A14476
PH4967	A14476PLUS
PH4997	A14478PLUS
PH4998	A58
PH49A	A67SP
PH49AFP	A67SP

FRAM	PARTMO
PH49AJS	A67SP
PH5	A1428
PH5010A	A323
PH5046	A73
PH5100	A232SP
PH5102	A232SP
PH5114	A4044
PH5123	A7029SP
PH5123	A7029SP
PH5123	A7029SP
PH5124	A7029SP
PH5124	A7029SP
PH5124	A7029SP
PH5135	A7105SP
PH5136	A010
PH5136	A105SP
PH5166	A1406
PH5166	A1406PLUS
PH5166	A14476
PH5195	A73
PH5203	A2863SP
PH5203	A2863SP
PH5203	A350
PH5280	A52
PH5280	A53PLUS
PH5317	A1402
PH5343	A1402
PH5343	A1402PLUS
PH5367	A91480
PH5394	A67SP
PH5443	A20
PH5443	A20PLUS
PH5449	A349SP
PH5491	A20
PH5491	A20PLUS
PH5491	AR1218
PH5529	A7028SP
PH5541	A1402
PH5660	A14302PLUS
PH5778	A116SP
PH5796	A3603
PH5796	A3603PLUS
PH5949	A1402
PH5FP	A1428
PH6010	A323
PH6010A	A323
PH6010A	A52
PH6010A	A53PLUS
PH6016	A14302PLUS
PH6017	A58
PH6017	A58PLUS
PH6017	A58T
PH6017A	A58
PH6349	A3000SP
PH6349	A3000SP
PH6349A	A3000SP
PH6354	A142SP
PH6355	A092SP
PH6355	A28SP
PH6356	A142SP
PH6357	A91480
PH6607	A52
PH6607	A53PLUS

FRAM	PARTMO
PH6607	A58
PH6643	A343
PH6644	A22SP
PH6657	A291
PH6682	A178PLUS
PH6811	A323
PH6811	A52
PH6811	A53PLUS
PH7136	A309SP
PH7138	A408SP
PH7138FP	A408SP
PH7309	A16242SP
PH7317	A1402
PH7317	A1402PLUS
PH7325	A2863B
PH7325	A2863SP
PH7325	A350
PH7328	A20
PH7328	A20PLUS
PH7328	AR1218
PH7362	PM1878100752
PH7405	A495SP
PH7405A	A495SP
PH7405AFP	A495SP
PH7496	A9003SP
PH7500	A299E
PH7575	A14302PLUS
PH7718	A840SP
PH7728	A7041SP
PH7728	A7041SP
PH7728	A205SP
PH8025	A1403SP
PH8316	A1406
PH8316	A14476
PH8531	A7158SP
PH8690	A9080SP
PH8691	A9080SP
PH8691A	A9080SP
PH8842	A67SP
PH8910	A1403SP
PH8920	A1403SP
PH8936	A7028SP
PH8942	A7177SP
PH8960	A9080SP
PH8A	A1
PH8A	A1SP
PH8AFP	A1
PH8AFP	A1SP
PH9055	A7028SP
PH9116	A7105SP
PH922	A14302PLUS
PH922A	A14302PLUS
PH927	A14302PLUS
PH9503	AL106
PH9566	A14302PLUS
PH963B	A113
PH966	A14302PLUS
PH966B	A14302PLUS
PH966B	A18
PH966B	A18PLUS
PH966B11	A18
PH966B11	A18PLUS
PH9688	A323

FRAM	PARTMO
PH9688	A52
PH9715	A58
PH9715	A58PLUS
PH9715	A58T
PH9748	A7133
PH977	AR17
PH977A	AR17
PH9837	A1432
PH9971	A9025SP
PH9971A	A9025SP
PH9A	A14302PLUS
PR3304	AW5137SP
PR3414	AW2010SP
PR3433	AW2022SP
PR3753	AW2016SP
PR393	AW475SP
PR7308	AW2010SP
PR7308	AW2016SP
PR7570	AW2016SP
PR8694	AW2127SP
PR9884	AW2237SP
PS10235	AS201SP
PS10475	PFG448
PS10701	AS46018SP
PS10713	A1212SP
PS11117	AS950SP
PS3712	A1212SP
PS3712	ASV1212SP
PS3720	A7533SP
PS4886	A4886
PS4886	A570DSP
PS4886	AK570SP
PS4922	A7533DSP
PS4922	A7533SP
PS5138	A7533SP
PS5896	PFG7958
PS6554	A1230
PS6554A	A1230
PS6554A	AS1230SP
PS6643	A1204SP
PS6643	AS1282SP
PS6643	ASV1282SP
PS6829	A1259SP
PS6829	AS1249SP
PS6830	A5813SP
PS6832	A1212SP
PS68360	AS3202SP
PS6838	A1212SP
PS6839	A1285DSP
PS7140	A1345SP
PS7170	A1345SP
PS7171	A7301DSP
PS7171	AS1441SP
PS7714	AS5850SP
PS7716	AR90D
PS7716	ASR90TSP
PS7716	ASV90TSP
PS8048	A1259SP
PS8132	A1230
PS8185	A1204SP
PS8186	A1345SP
PS8186	AS830SP
PS8187	AS1441SP

FRAM	PARTMO
PS826	A14302PLUS
PS8428	A1226LSP
PS8479	A97
PS8486	AS5850SP
PS8687	AS1003SP
PS8688	AS1040SP
PS8689	AS1272SP
PS9028	AR90D
PS9028	ASR90TSP
PS9451	PFG391
PS9794	AS5850SP
PS9915	AR90D
PS9915	ASR90TSP
PZ38	A1406
PZ38	A14476
R2521683	AP114215145
R3739636	AP2425
S3TC	PM3
TCA326	AP121
TG16	A20
TG16	A20PLUS
TG16	AR1218
TG2	A329
TG25	A33
TG2870A	A178PLUS
TG2951	A113
TG30	A11
TG3387A	A111
TG3593A	A1402
TG3600	A243
TG3614	A14302PLUS
TG3675	A1432
TG3682	A113
TG3786	A3786SP
TG3950	A4044
TG3980	A4011
TG4967	A14476
TG6607	A58
TG7317	A1402
TPH7405AFP	A495SP
TPH8691AFP	A9080SP
TPH8842FP	A67SP
VB20511	AP35790
XA1813	AP35553
XG2	A329
XG2870A	A178PLUS
XG2951	A113
XG30	A11
XG3387A	A111
XG3593A	A1402
XG3600	A243
XG3614	A14302PLUS
XG3682	A113
XG3950	A4044
XG43	A20
XG43	A20PLUS
XG5	A1428
XG8A	A1
XPI428	A354
FRANIG	PARTMO
GA651	AP3178
GF61	PFG516K
HCA0115	AP3191

FRANIG	PARTMO
HCA04000	AP31820
HCA0500	APC20500
HCA0508	AP31528
HCAOX200	AP31747
HCA10086	AP3108
HCA1010	AP3113
HCA10191	AP35790
HCA10234	AP3132
HCA1027A	AP147
HCA10293	AP35815
HCA1035SY	AP2712SY
HCA1045	AP2253
HCA10997	AP35844
HCA1103	APR12
HCA1104	AP3
HCA11053	AP31832
HCA11077	AP48772
HCA1112	AP1861
HCA1119	AP4041
HCA1121	AP121
HCA11222	AP350990
HCA1124	APR18
HCA1126	AP126
HCA1127	AP127
HCA1129	APR9
HCA1131	AP410
HCA1132	AP132
HCA1133	AP323
HCA1134	AP4337
HCA1136	AP626
HCA1137	AP2300
HCA1138	AP6261
HCA1139	AP33
HCA1142	AP142
HCA1147	AP147
HCA1164	AP146
HCA1165	AP05120
HCA1168	AP05113
HCA11711	AP1312
HCA12065	AP31980
HCA12065	AP31985
HCA1330	AP17871
HCA1330SY	AP17871SY
HCA1413	AP21413
HCA1444Q8	AP31874
HCA1500	AP31511
HCA1501	AP3178
HCA1502	AP3176
HCA1532K	AP2360
HCA1550	AP57MD31
HCA1551	AP57MD21
HCA1574	AP2425
HCA1580	AP2520
HCA1580H	AP2520H
HCA1581	AP117797
HCA1582	AP2482
HCA1588	AP46530
HCA1588MB	AP17308
HCA1588SY	AP46531
HCA1591	AP95600906
HCA1596	AP182028
HCA1596SY	AP137640
HCA18115	AP2941

CRUCE DE REFERENCIAS

FRANIG	PARTMO
HCA1814SY	AP4863
HCA1833	AP351833
HCA1DMF	AP5H100
HCA1R100	AP31100
HCA2004	AP35590
HCA2005	AP31550
HCA2014	AP35433
HCA2023	AP35915
HCA2028	AP2206
HCA2058	AP3562
HCA2088	AP29400
HCA2098	AP3115
HCA2100	AP311020
HCA2114	AP35893
HCA2142	AP3118
HCA21501	AP356020
HCA2167	AP3123
HCA2200	AP3514
HCA2208	AP3128
HCA2220	AP3119
HCA2224	AP2224
HCA224	AP4M8047
HCA2243	AP1365
HCA226	AP4M9334
HCA2266	AP352660
HCA2277	AP5L40A
HCA22K00	AP311002
HCA2344	AP3138
HCA2351	AP3135
HCA23603	AP2562
HCA237	AP4M8048
HCA2395	AP3129
HCA2400	AP35660
HCA2410	AP35786
HCA2410	AP35786
HCA2439	AP4439
HCA2441	AP31588
HCA2466	AP3133
HCA2485	AP4495
HCA2494	AP4494
HCA2502	AP1312
HCA25021	AP1312
HCA2523	AP1375
HCA2523K	AP25867
HCA2525	AP1298
HCA2526	AP1294
HCA2536	AP16546
HCA253K	AP101222K
HCA2541	AP1330
HCA2548	AP812105
HCA2548SY	AP114215145
HCA254K	AP101234K
HCA2567	AP3578
HCA256K	AP101275K
HCA2573	AP3511
HCA2576	AP2576
HCA2577	AP2577
HCA258	AP101246K
HCA258K	AP101246K
HCA2592	AP7N1225
HCA2599	AP3102
HCA26011	AP35606
HCA2602	AP35591

FRANIG	PARTMO
HCA2602	AP35665
HCA2607	AP2021
HCA2620	AP35793
HCA2640	AP3570
HCA2657	AP99727
HCA2669	AP3582
HCA2676	AP127312
HCA2676SY	AP127313
HCA2690	AP3568
HCA2697	AP35781
HCA2700	AP1087
HCA2717	AP3537
HCA2744	APH100
HCA2750	AP3550
HCA2778	AP31550
HCA2797	AP524344
HCA2799	AP4636
HCA2800	AP31734
HCA28113	AP2510
HCA2816	AP2240
HCA2818	AP2263
HCA2828	AP31559
HCA2828	AP3509
HCA2857	AP3709
HCA2863	AP2863
HCA2863SY	AP3501
HCA29020	AP31711
HCA2905R	AP3565
HCA2918	AP3134
HCA2959	AP3513
HCA2997	AP3557
HCA2H910	AP35645
HCA3190	AP13190
HCA3190SY	AP13190SY
HCA3200	AP2205
HCA3280	AP2291
HCA3280SY	AP4091
HCA3281	APC203252
HCA3281SY	APC203252SY
HCA3338	AP1063
HCA33381	AP1051
HCA3610	APC23610
HCA3610SY	APC23610SY
HCA3630K	AP87657
HCA3733	AP3736
HCA3733SY	AP3737
HCA3782	AP2216
HCA3782SY	AP4416
HCA3823	AP203823
HCA3824	AP2632
HCA3913	AP2660
HCA3924	AP3924
HCA3960	AP39601
HCA3990	AP2705
HCA3Z40	AP3111
HCA3Z40	AP3511
HCA4000	AP4000
HCA4010	AP3142
HCA4350	APH100
HCA4350K	AP3500
HCA4485	AP4495
HCA4520	AP45020
HCA4599	AP3102

FRANIG	PARTMO
HCA4800	APG4800
HCA4940	AP3124
HCA4D000	AP3122
HCA4H000	AP3107
HCA502	APCA502
HCA5021	AP5021
HCA5021SY	AP51250
HCA5036	AP8054
HCA5051	AP85051
HCA507	AP110558
HCA5070	AP2712
HCA5070	AP2712A
HCA50701	AP2877S
HCA50701SY	AP2877SY
HCA507SY	AP106775
HCA518	AP1130E
HCA5203	AP5203
HCA5203SY	AP5217
HCA523SY	AP4129908
HCA5400	AP3920
HCA5592	AP84457
HCA5626	AP5627
HCA5724	AP3554
HCA5771	AP2825
HCA5772K	AP3193
HCA595	AP57MD33
HCA5A500	AP5A500
HCA6000	APG6000
HCA62010	AP62010
HCA6324	AP2688
HCA6362	AP3932
HCA6512	AP2680
HCA6544	AP31555
HCA6550	AP16550
HCA6850	AP31544
HCA7104	AP20457
HCA7140	AP3518
HCA7140SY	AP3518SY
HCA7246	AP7242
HCA7402	AP3114
HCA7626	AP3136
HCA7630	AP3138
HCA7655	AP0978
HCA7723	AP3146
HCA77A00	AP3588
HCA78040	AP2279
HCA78110	AP78090
HCA8000	AP311005
HCA8030	AP78020
HCA8038	AP3707
HCA8040	AP8040
HCA8104	AP2425
HCA8180	AP3539
HCA8233	AP1908233
HCA8244	AP14210
HCA8244SY	AP14220
HCA8280	AP8280
HCA8466	AP3548
HCA8548	AP3581
HCA8890	AP3190
HCA9060	AP2884
HCA9100	AP17845
HCA9100SY	AP17846

FRANIG	PARTMO
HCA9115	AP31653
HCA9246	AP3988
HCA9246SY	AP17845
HCA9269	AP3542
HCA9269SY	AP3543
HCA9322	AP99322
HCA9551	AP4001
HCA95511	AP3532
HCA9601	AP3536
HCA9601	AP3536
HCA9604	AP25653
HCA9683	AP3116
HCAB70A	AP3127
HCAB9000	AP31936
HCABJ1065	AP93019
HCAC010	APC010
HCAE513	AP3193
HCAE513K	AP0590E
HCAE513K	AP3193
HCAE522	AP2561
HCAE523K	AP3600
HCAGD10T	AP1325
HCAGD10TSY	AP1330E
HCAHD120	AP6A701
HCAJD20B	AP35750
HCAK1532	AP2360
HCAK6B0	AP2959
HCALO40	AP35977
HCAL300	APL300
HCAL3001	APL300
HCAMA70A	AP3270
HCAS001	AP9S001
HCAT45	APSL5013Z40A
HCA000	AP3144
HCC0878	AP40878
HCC10553	AP31060
HCC10627	AP31055
HCC10627	AP31743
HCC10728	AP31043
HCC10731	AP31026
HCC11184	AP31054
HCC12160	AP43100
HCC2176	AP31032
HCC4420	AP31030
HCC4421	AP31002
HCC52020	AP31071
HCC7238	AP31019
HCC9691	AP31068
HCC9858	AP31032
HCC9881	AP31631
HCF0408	PFG460
HCF0490	PFG357
HCF2100	PFG3191102100
HCF4777	PFG1104
HCF5140	PFG420
HCF6469	PFG1191
HCF65D0	PFG368
HCFINT1G	PFG1C000
HCH2311	PP5706
HCH7401	PFG453
HCPOX133	PP40425
HCP10246	PP85674
HCP103P	PMX1878100501

FRANIG	PARTMO
HCP11	PM174
HCP120B	PM192
HCP12246	PP95785
HCP1320	PM1320
HCP1443	PP7181
HCP1650	PM1650
HCP1682	PP11682
HCP1682	PP11682SP
HCP1730	PM1730SP
HCP1940	PM1940
HCP19813	PM1878100752
HCP19814	PM9885111911
HCP19AF	PM325
HCP19AP	PM2851Z
HCP19F	PM324
HCP19F	PM324E
HCP2010	PP201010
HCP2010	PP201030
HCP2240	PM2240
HCP23	PM210
HCP2833	PP6705
HCP2927	PM0011843925
HCP2A	PM245
HCP2F000	PP2F000
HCP3	PM3
HCP31	PM17
HCP4500	PP04041
HCP4811	PP24811
HCP4870	PP19925
HCP516	PM343
HCP5466	PP15562
HCP613	PM248
HCP7	PM126
HCP707	PM707
HCP707	PM707E
HCP750P	PMX750R
HCP7540	PP7444
HCP7772	PM7680
HCP8010	PP808010
HCP8091	PP78091
HCP8091	PP78091SP
HCP8110	PP7751
HCP8221	PP1112
HCP8530	PP5562
HCP8580	PP88580
HCP8751	PP7199
HCP8970	PP28970
HCP8A	PM197
HCP9001	PM9885132652
HCP9002	PM1878100271
HCP9003	PM1878100270
HCP9168	PM19624SP
HCP9260	PP9452
HCP9262	PP7735
HCP9558	PP7230SP
HCP9760	PM9760
HCP9915	PP79915SP
HCPCD1065	PM7572
HCPCL2632	PM4031840025
HCPEV550	PPEV430
HCFFF51	PM313
HCPL070	PP7476
HGX033	A4047

FRANIG	PARTMO
HGX046	A1480
HGX091AE	A091AE
HGX093	A093DSP
HGX093	A093SP
HGX095	A232SP
HGX1	A1
HGX1	A1SP
HGX10027	A1006SP
HGX10268	A329
HGX105	A23
HGX105	A23SP
HGX10575	A52041SP
HGX105A	A23A
HGX105A	A23ASP
HGX106	A106
HGX106	A1212SP
HGX106	ASV1212SP
HGX10600	A15403
HGX1112	A23L39
HGX1112	A23L39SP
HGX1126E	A43SP
HGX1131	A46SP
HGX1131	A46SP
HGX118	P3461
HGX1242	AS1249SP
HGX14	A12
HGX1403	A1403SP
HGX14A	A33
HGX1549	A339SP
HGX161	A1480
HGX1616	A14616
HGX1616	A14616PLUS
HGX17A	AR17
HGX18A	P346P
HGX1T70	A5368SP
HGX2	A11
HGX2010	A1402
HGX2010	A1402PLUS
HGX2051	A7105SP
HGX218	A30SP
HGX218	A30SP
HGX219	A31SP
HGX219	A31SP
HGX22	A54SP
HGX2261	AA5374
HGX23	A48SP
HGX2390	A4048SP
HGX25010959	A97C
HGX25011011	A96C
HGX2849A	A323
HGX2849A	A323PLUS
HGX2849M	A73
HGX2849M	A73PLUS
HGX2856	A4044
HGX2870	A4056
HGX2870A	A178PLUS
HGX2870A	A243
HGX28H	A092SP
HGX28NK	A4271SP
HGX28NK	A4271SP
HGX2900	AS201SP
HGX2921	A091AE
HGX2951	A4050

CRUCE DE REFERENCIAS

FRANIG	PARTMO
HCX2951	A4050PLUS
HCX2977A	A2863B
HCX2977A	A2863SP
HCX2A	A26SP
HCX2A	A26SP
HCX30	A48MC
HCX3000	A3000SP
HCX3000	A3000SP
HCX3191	A67SP
HCX3191K	A85
HCX3191P	A9N6007SP
HCX3303	AW475SP
HCX3304	AW2010SP
HCX3305	AW2022SP
HCX3318	A43SP
HCX3335	A69SP
HCX3375	A116SP
HCX3380	A1R0751SP
HCX3380	A1R0751SP
HCX3380A	A588
HCX3380A	A588SP
HCX3387	A9797PLUS
HCX3387A	A43S
HCX3414	AW2016SP
HCX3416A	A129SP
HCX3519	A9N5570SP
HCX3535	A4011
HCX3555	A777SP
HCX3593A	A52
HCX3593A	A53PLUS
HCX3612	A116CSP
HCX3614	A14302PLUS
HCX3614	A223
HCX3627	A034L
HCX3682	A113
HCX3690	A105SP
HCX3726	A3726
HCX3726	A3726SP
HCX3727	PFG481I
HCX3757	A205SP
HCX3766	A134
HCX3802N	A3802N
HCX3900	A427SP
HCX3908	AW5137SP
HCX3950	A4044
HCX3A	A50
HCX400BMG10	A70015SP
HCX4102	A243004
HCX4102	A243004SP
HCX4102	A33358
HCX4102G	A243004DSP
HCX4102G	A243004DSP
HCX4302	A28SP
HCX4302	A28SP
HCX4386	A1406
HCX4386	A1406PLUS
HCX446	A4886
HCX446	A570DSP
HCX446	AK570SP
HCX446G	A4886
HCX446G	A570DSP
HCX446G	AK570SP
HCX4562C1	A3786SP

FRANIG	PARTMO
HCX46	A20
HCX46	A20PLUS
HCX4618310	A4618310
HCX4625547	A22SP
HCX4667755	A349SP
HCX47	AR1218
HCX4731	A4731SP
HCX47A	AR9
HCX48	A84SP
HCX483GB431	A150F
HCX483GB431	A150F
HCX4881	A105SP
HCX4922	A7533DSP
HCX4922	A7533SP
HCX4922G	A1CSP
HCX4967	A14476
HCX4967	A14476PLUS
HCX5	A4054SP
HCX50	A4041
HCX50D	A18
HCX50D	A18PLUS
HCX5566	A4056
HCX596	P596
HCX6	A4046
HCX60	A915
HCX6438839	A96
HCX6438839G	A5813SP
HCX6438840	A97
HCX6438840	A97SP
HCX6554A	AS1230SP
HCX6554AG	A1230
HCX6607	A58
HCX6607	A58PLUS
HCX6607	A58T
HCX6643G	A1204SP
HCX6657	A291
HCX6910	AS201SP
HCX6D	A4047
HCX7	A14302PLUS
HCX7	A223
HCX70010	A70010
HCX70016	A70016SP
HCX7029	A7029SP
HCX7029	A7029SP
HCX7041	A7041SP
HCX7041B	A2700SP
HCX7053	A840SP
HCX7104G	AS103SP
HCX7105	A7105SP
HCX7136	A309SP
HCX7153	A330C
HCX7170	AS830SP
HCX7170G	A1345SP
HCX7301	A7301DSP
HCX7317	A1402
HCX7317	A1402PLUS
HCX7496	A4863
HCX7496A	A9003SP
HCX7549	A840SP
HCX7602	A7602
HCX7716	AR90D
HCX7716	ASR90TSP
HCX7716	ASV90TSP

FRANIG	PARTMO
HCX798	A56670
HCX8018	AL106
HCX8019G	AS36209SP
HCX8040	A1204SP
HCX8043G	A243004DSP
HCX8043G	A243004DSP
HCX820	A329
HCX8486	AS5850SP
HCX9008	A7018
HCX9009	A3000SP
HCX9110	A4271SP
HCX9110	A4271SP
HCX94143479	A4053SP
HCX94143479K	A4054SP
HCX943340259	A4052SP
HCX94340259	A4052SP
HCX94423700	A142SP
HCX94463713	A4051SP
HCX9452	A408SP
HCX9501	AS1228SP
HCX9617	A7898SP
HCX9715	A58
HCX9715	A58PLUS
HCX9715	A58T
HCX9845G	AS200SP
HCX9924321	A1CSP
HCX9924321	A7602
HCX993G	A243004DSP
HCX993G	A243004DSP
HCX9C	A941C
HCX9C	A941SP
HCXA046	A1480
HCXB6217N	A7533C
HCXD4NNB486D	A354
HCXME016872	A292
HCXME016872	A292
HCXR6	AR46
HCXR6A	AR4M
HCXR9	A3603
HCXR9	A3603PLUS
HCXT45	A4048SP
HCXT45B	A4049SP
HCXW6000	A26000SP
HCXW6000G	AS12226SP
HQAC3042	AP43042
LUBERFINER	PARTMO
272	PFG516K
750	PMX750R
1500	PMX750R
2126	PMX750R
2142	PMX750R
2143	PMX750R
2151	PMX750R
2250	PMX750R
2261	PMX750R
2432	PMX1878100501
2580	PMX750R
2661	PMX750R
2763	PMX750R
2764	PMX750R
2765	PMX750R
2793	PMX750R

LUBERFINER	PARTMO
2871	PMX750R
2938	PMX750R
2984	PMX750R
3035	PMX750R
3036	PMX750R
3118	PMX750R
3132	PMX750R
3250	PMX750R
3289	PMX750R
3326	PMX750R
3698	PMX750R
3730	PMX750R
3845	PMX750R
3850	PMX750R
3900	A427SP
3972	PMX750R
4008	PMX750R
4009	PMX750R
4100	PMX750R
4407	PMX750R
4662	PMX750R
5133	AW2010SP
5133	AW2016SP
24561	A15
28712	PMX750R
38454	PMX750R
1607320	A129SP
2056480000	A46SP
2126LUB	PMX750R
7502C	PMX750R
7503C	PMX750R
750B	PMX750R
750C	PMX750R
750CT	PMX750R
750MIC	PMX750R
A1400C	AP3500
AF1043	AP3562
AF1046	AP1305
AF1058	AP146
AF107	AP25867SY
AF116	APR12
AF1300	AP3707
AF1300	AP3707
AF1301	AP3707
AF134	APR9
AF14	AP1323
AF1615	AP3515
AF1618	AP35793
AF1658	AP1365
AF1683	AP3557
AF1695	AP35736
AF1696	AP3557
AF1744	AP1365
AF1754	AP35755
AF1862	AP5021
AF1863	AP51250
AF2014	AP35433
AF2341	AP25600
AF241	AP1330
AF2441	AP3112
AF252	AP3932
AF253	APL300
AF25484	AP3543

LUBERFINER	PARTMO
AF25553	AP3988
AF25555	AP3542
AF261	AP4337
AF2610	AP4337
AF2780	AP35602
AF27817	AA5374
AF280	AP603A
AF293	AP1312
AF3054	AP3571
AF307	AP626
AF328	AP142
AF331	AP6261
AF335M	AP4M9334
AF341	AP4M9379
AF348	AP121
AF351	AP3129
AF353	AP1323
AF355	AP35645
AF359	AP3179
AF3595	AP31628
AF360	AP31550
AF3603	AP35939
AF368	AP1861
AF370	AP3124
AF371	AP31555
AF372	AP3142
AF375	AP531
AF376	AP16546
AF379	AP4M9379
AF380	AP1368
AF386	AP35815
AF3895	AP31834
AF3959	AP3116
AF3975	AP3196
AF3981	AP3450
AF3993	AP3108
AF4003	AP29400
AF4014	AP3122
AF4015	AP31801
AF4022	AP35961
AF4023	AP3132
AF4025	AP31795
AF4031	AP31753
AF4033	AP3144
AF4042	AP3191
AF4046	AP3513
AF415	AP561
AF418	AP1861
AF425	AP3562
AF4523	AP1347
AF474	AP1323
AF4904	AP35844
AF4977	AP3568
AF5184	AP311001
AF5209	AP350990
AF522	AP3119
AF5260	AP31980
AF5584	AP3108
AF603	AP323
AF633	AP4041
AF661	AP4337
AF662	AP1087
AF664	AP4337

LUBERFINER	PARTMO
AF70	AP3709
AF736	AP127
AF736	AP147
AF773	AP126
AF773	AP2300
AF7800	AP31511
AF7819	AP3568
AF7825	AP31544
AF7825	AP31544
AF7826	AP31559
AF7826	AP31564
AF7826	AP3509
AF7832	AP3123
AF7833	AP3118
AF7837	AP31511
AF7841	AP3135
AF7842	AP3137
AF7843	AP3138
AF7845	AP3574
AF7859	AP3170
AF7861	AP3138
AF7863	AP1339
AF7864	AP3170
AF7867	AP3136
AF7874	AP6261
AF7876	AP31531
AF7877	AP1323
AF7881	AP3582
AF7885	AP35644
AF7892	AP3133
AF7893	AP31521
AF7905	AP3567
AF7910	AP1323
AF7913	AP1292
AF7914	AP3128
AF7919	AP3139
AF7935	AP35591
AF7935	AP35665
AF7937	AP35606
AF7938	AP3134
AF7939	AP355344
AF7959	AP31678
AF7964	AP31653
AF7976	APSL40A
AF7991	AP3125
AF8248	AP3121
AF826	AP121
AF8903	AP537
AF8917	AP4001
AF8918	AP5H100
AF8936	AP4494
AF89550	AP2482
AF8956	AP1298
AF8956	AP6293
AF898	AP3179
AF905	AP3924
AF9098	AP63680
AF9912	AP31992
AFL2513HDR	AP3518
AFP5158	AP3532
AR95758	AP127312
CAF1733	AP31631
CAF1813P	AP31060

CRUCE DE REFERENCIAS

LUBERFINER	PARTMO
CAF1816C	AP31071
CAF1816P	AP31071
CAF1817P	AP31029
CAF1825F	AP31043
CAF1825P	AP31043
CAF1845P	AP31033
CAF1852P	AP31088
CAF1870P	AP31026
CAF1885P	AP31032
CAF1941P	AP31097
CAF24003	AP31037
CAF24003XL	AP31037
CAF24005	AP43042
CAF24005XL	AP43042
CAF24016	AP31036
CAF24016XL	AP31036
CAF7798	AP31035
F521	PM126
FF2	A48MC
FF2D	A70010
FF2D	A915
FF42000	A243004
FF5624	A614
FN90	PFG481I
FP20	A26SP
FP20	A26SP
FP251F	A23L39
FP251F	A23L39SP
FP570F	A305F
FP585F	A243004
FP585F	A243004SP
FP585F	A33358
FP586F	A243004
FP586F	A243004DSP
FP586F	A243004DSP
FP586F	A33358
FP586FE	A243004
FP586FE	A33358
FP587F	A1226
FP587F	A1226ISP
FP588F	A034L
FP588F	A4053SP
FP588F	A5138SP
FP590F	A4047
FP591F	A4053SP
FP591F	A4053SP
FP603	A588
FP603	A588SP
FP925F	A46SP
FP941F	A4886
FP941F	A570DSP
FP941F	AK570SP
FP941F	AK570SP
FS1022	AS1272SP
FS1291	AS5850SP
FS19532	ASR90TSP
FS19931	A7301DSP
FT5362	PFG481I
FT5372	PFG481I
G1	PFG516K
G1010	PFG7802
G1036	PFG7742
G1063	PFG7742

LUBERFINER	PARTMO
G246	PFG1105
G2908	PFG1195
G2920	A7533DSP
G2920	A7533SP
G2930	PFG1104
G2932	PFG44781
G2961	PFG805
G2962	PFG44781
G2981	PFG516K
G341	PFG805
G478	PFG516K
G492	PFG516K
G516	PFG516K
G6335	PFG1104
G6351	PFG1163
G6352	PFG805
G6367	PFG872
G6384	PFG1104
G6387	PFG1105
G6400	PFG0120490B
G641	PFG805
G6598	PFG3191125000
G6630	PFG7958
G752	PFG805
G800	PFG1105
G8154	PFG1195
HP1	A1
HP1	A1SP
L1040C	AS1040SP
L1261F	PP7777SP
L2020F	PP202030
L2020F30	PP202030
L2020FN	PP202030
L2020FN2	PP202030
L2021F	PP201010
L2021F	PP201030
L202F	PP201010
L24A	A7105SP
L25F	PP246
L296F	P346P
L296FE	P346P
L334	A1
L334	A1SP
L3523F	PFG323
L3525F	AS1282SP
L3525F	ASV1282SP
L3528F	PM9885111911
L3528F52	PM9885111911
L3578	PM7680
L3578F	PM7680
L3578FN	PM7680
L3921F	AS7784D
L5021F	PP7751
L5085F	PP22135
L5098F	PP28970
L5467F	PM19624SP
L5476FNXL	PM19624SP
L5947F	PM9760
L60F	PM707
L60F	PM707E
L61F	PM28S1Z
L750	PMX750R
L750P	PMX750R

LUBERFINER	PARTMO
L8701F	PP7735
L8967F	PP7761
L8994F	PP7761
L9684F	PP19684SP
L9721F	PM19624SP
L9721F	PM7680
L9765FXL	PM19765SP
L9890F	PM1940
LAF1146	AP95600906
LAF124	AP6261
LAF1246	AP101246K
LAF1246A	AP101246K
LAF1246B	AP101246K
LAF1248	AP101246K
LAF1275	AP101275K
LAF1275A	AP101275K
LAF1275B	AP101275K
LAF1465	AP127312
LAF1591	AP95600906
LAF1712	APG4800
LAF1718	AP2291
LAF1719	AP4091
LAF1720	APC203252SY
LAF1725	AP87658
LAF1754	AP106775
LAF1757	AP110558
LAF1760	APCA502
LAF1790	AP4416
LAF1793	AP2489
LAF1800	AP2712
LAF1800	AP2712
LAF1800	AP2712A
LAF1801	AP7N1225
LAF1804	AP4129907
LAF1806	AP524344
LAF1813	AP2688
LAF1814	AP2621
LAF1833	AP2805
LAF1834	AP5021
LAF1835	AP51250
LAF1849	AP3518
LAF1849MXM	AP3518
LAF1866	AP101222K
LAF1866	AP4000
LAF1878	AP2863
LAF1931	AP2521
LAF1947	AP2761
LAF1953	AP2654
LAF1956	AP3518SY
LAF2052	APC203252
LAF22013	AP87657
LAF222	AP101222K
LAF222	AP101222K
LAF222A	AP101222K
LAF2342	APC20500
LAF2343	APC20500SY
LAF234HD	AP101234K
LAF234HDA	AP101234K
LAF234HDB	AP101234K
LAF2526121030	AP137640
LAF2541	AP4M9335
LAF2736	AP4M8048
LAF2831	AP2632

LUBERFINER	PARTMO
LAF323	AP46530
LAF323	AP46531
LAF3232	AP3500
LAF331	AP6261
LAF334	AP4M9334
LAF335	AP4M9335
LAF348	AP121
LAF3551	AP2705
LAF3551MXM	AP2705
LAF3585	AP3501
LAF3657	AP127313
LAF3705	AP2677
LAF376	AP16546
LAF3779	AP101234K
LAF3779A	AP101234K
LAF3779B	AP101234K
LAF378	AP4M9378
LAF379	AP4M9379
LAF3864	AP5627
LAF3890	AP3722
LAF3916	AP127312
LAF3930	AP3548
LAF3947	AP3920
LAF3948	AP3921
LAF3949	AP20457
LAF4163	AP25867SY
LAF4179	AP7242
LAF4192	AP2621
LAF4498	AP2690
LAF4544	AP3544P
LAF4545	AP3545
LAF4601	APC23610
LAF4602	APC23610SY
LAF47	AP4M8047
LAF48	AP4M8048
LAF4801	APC23610
LAF4816	AP3539
LAF5028	AP3570
LAF54	AP3129
LAF5429	AP80006
LAF5429	KITAP80006 / AP80006SY
LAF5505A	AP101222K
LAF5505B	AP101222K
LAF5572	AP2825
LAF558	AP2576
LAF559	AP2576
LAF559	AP2577
LAF5590	AP54100
LAF5598	AP2884
LAF5633	AP2877S
LAF5717	AP3518
LAF5720	AP2654SY
LAF5732	AP821884
LAF5761	AP14210
LAF5762	AP14220
LAF5765	AP3736
LAF5770	AP17845
LAF5846	AP3838
LAF5847	AP3722
LAF5868	AP3737
LAF5888	AP127312
LAF5955	AP17846

LUBERFINER	PARTMO
LAF5959	AP5627
LAF6032	AP101246K
LAF6108	AP2741
LAF6128	AP2705
LAF6142	AP3548
LAF6242	AP84457
LAF6300	AP2425
LAF633	AP4041
LAF6632	APCA502
LAF6641	APCA502SY
LAF6643	APCA502SY
LAF6663	AP4862
LAF6664	AP4863
LAF6769	AP110558
LAF6775	AP106775
LAF6834	AP4129908
LAF6918	AP57MD33
LAF6918D	AP57MD33
LAF694	AP2660
LAF695	AP2680
LAF6986	AP4986
LAF70	AP3709
LAF7315	AP114215145
LAF7531	AP4M9378
LAF7640	AP137640
LAF7653	AP3542
LAF7672	AP110558
LAF7752	AP57MD21
LAF7757	AP57MD31
LAF7797	AP117797
LAF8043	AP2660
LAF8078	AP2825
LAF8081	AP3193
LAF8143	AP3988
LAF8145	AP3736
LAF8148	AP3542
LAF8184	AP3542
LAF8528	AP101222K
LAF8537	A232SP
LAF8552	AP46530
LAF8572	AP2360
LAF8619	APSL5013Z40A
LAF8636	A267
LAF8638	AP101222K
LAF8662	AP4000
LAF8691	AP3936
LAF8955	AP2482
LAF8996	AP3570
LAF9000	AP812105
LAF9001	AP25867
LAF9001	AP25867
LAF90011249095490	AP25867
LAF9099	AP4636
LAF9102	AP4637
LAF9201	AP4642
LAF9332	AP3543
LAF9373	AP106775
LAF942	AP2520
LAF942	AP2520H
LAF9538	AP2360
LAF9545	AP182028
LAF9778	AP87658

LUBERFINER	PARTMO
LF100	A48MC
LF1282	AS1282SP
LF1311I	A15
LF2020FN2	PP202030
LF2433	PMX1878100501
LF3331	A48SP
LF3553	A034L
LF3553	A5138SP
LF3578F	PM7680
LF3703	A7125
LF3977	A7174SP
LF451130	A70015SP
LF5467F	PM7680
LFF1000	A1259SP
LFF1003	AS1003SP
LFF1007	AS1040SP
LFF1065	AS1003SP
LFF1105	AR16SP
LFF1223	AS1441SP
LFF1224	A830
LFF1225	A830
LFF1225	AS1441SP
LFF1282	AS1282SP
LFF2	A70010
LFF2040	PP204030
LFF2201	A7766SP
LFF22011	A70015SP
LFF2213	A20
LFF2213	A20PLUS
LFF2213	AR1218
LFF3291	A97
LFF3292	AR90D
LFF3292	ASR90TSP
LFF3292	ASV90TSP
LFF3293	AS4654SP
LFF3343	A7614SP
LFF3347	A1P2299
LFF3347	A1P2299
LFF3349	A588SP
LFF3357	A787
LFF3362	A7223SP
LFF3403	PM324
LFF3403	PM324E
LFF3403	PM707
LFF3403	PM707E
LFF3406	PM324
LFF3406	PM324E
LFF3415	A7602
LFF3417	A787
LFF3476	A7773SP
LFF3501	P3461
LFF3502	A4618310
LFF3504	A1226
LFF3504	A1226LSP
LFF3504	A33358
LFF3504	A33358L
LFF3507	PM28S1Z
LFF3507	PM325
LFF3520	PP246
LFF3521	A33358
LFF3526	A48MC
LFF3527	A292
LFF3527	A305F

CRUCE DE REFERENCIAS

LUBERFINER	PARTMO
LFF3527	A3726
LFF3527	A3726SP
LFF3530	A588
LFF3538	A7602
LFF3539	PP202030
LFF3540	AR16SP
LFF3553	A034L
LFF3553	A4053SP
LFF3553	A5138SP
LFF3579	A1345SP
LFF3579U	A1345SP
LFF3579U	AS830SP
LFF3584	A7653
LFF3802	A7813SP
LFF4136	A7602
LFF4293	A46SP
LFF4293	A46SP
LFF4293	A888
LFF4295	A034L
LFF4295	A4053SP
LFF4295	A4053SP
LFF4295	A4053SP
LFF4295	A5138SP
LFF4296	A330C
LFF4296	A941C
LFF4296	A941SP
LFF4470	A7656E
LFF4471	A7657
LFF4511	A70015SP
LFF4783	A1R0751SP
LFF4783	A1R0751SP
LFF4783RD	A1R0751SP
LFF4988	AR29SP
LFF5	A23
LFF5	A23SP
LFF5002	A1212SP
LFF5127	A56670
LFF5485	A7813SP
LFF5510	A70010
LFF5766	AS1441SP
LFF5780	A1P2299
LFF5780	A1P2299
LFF5784	A330C
LFF5823	A85
LFF5823B	A614
LFF5824	A1230
LFF5824	AS1230SP
LFF5824B	A1230
LFF5824U	A1230
LFF5825	PM325
LFF5850	AS5850SP
LFF5874	A7653
LFF5956	A4053SP
LFF5D	A1212SP
LFF5D	ASV1212SP
LFF7660	AS46018SP
LFF8000	A1212SP
LFF8000	ASV1212SP
LFF8010	A5813SP
LFF8011	A1212SP
LFF8012	A1212SP
LFF8020	A1212SP
LFF8020	ASV1212SP

LUBERFINER	PARTMO
LFF8050	A1212SP
LFF8059	A8059
LFF8060	A11213DSP
LFF8061	AS1282SP
LFF8061	AS4057SP
LFF8062	A1226
LFF8063U	A7301DSP
LFF8064	AS5850SP
LFF8093	A1894
LFF8101	A1218
LFF8288	A23
LFF8349	A588
LFF8350	A292
LFF8650	A1226LSP
LFF8727	A1212SP
LFF8806F	A7533SP
LFF8928	A1226LSP
LFF8928	A33358
LFF8930	A7533DSP
LFF8932	A5368SP
LFF8933	A7602
LFF8957	A7301DSP
LFF8957	AR90D
LFF8957	ASR90TSP
LFF8958	AS4057SP
LFF8958	AS950SP
LFF90012	A1285DSP
LFF9011	A1212SP
LFF9013	A1212SP
LFF9013	AS1249SP
LFF9013	ASV1212SP
LFF902	AS3202SP
LFF937	A96C
LFF9737	AS46018SP
LFH170	A54SP
LFH1701	A54SP
LFH1701001611107	A54SP
LFH4915	A91T1
LFH4917	A70015SP
LFH4926	A354
LFH4929	A70015SP
LFH4955	AR29SP
LFH4988	AR29SP
LFH5010	A291
LFH501125	A91T1
LFH5014	A116SP
LFH506810	A91T1
LFH5323	A9N5570SP
LFH6135	A91T1
LFH7355	A91T1
LFH8197	A91T1
LFH8243	A4863
LFH8395G	A70015SP
LFP1	A1
LFP1	A1SP
LFP11	A1
LFP11	A1SP
LFP1101F	A15
LFP1101FD	A15
LFP12	A11
LFP12	A12
LFP142F	A1P2299

LUBERFINER	PARTMO
LFP142F	A1P2299
LFP16	A20
LFP16	A20PLUS
LFP1652	A83910
LFPIA	A1
LFPIA	A1SP
LFP20	A26SP
LFP20	A26SP
LFP2050	A7105SP
LFP20501	A7105SP
LFP2160	A495SP
LFP2160XL	A495SP
LFP218F	A30SP
LFP218F	A30SP
LFP2190	A7105SP
LFP219F	A31SP
LFP219F	A31SP
LFP2213	A7028SP
LFP2216	A67SP
LFP2222	A840SP
LFP2229	A349SP
LFP2230	A22SP
LFP2234	A48SP
LFP2235	PM4031840025
LFP2238	A267
LFP2239	A7028SP
LFP2240	A1403SP
LFP2241	A232SP
LFP2244	A309SP
LFP2255	A2863B
LFP2255	A2863SP
LFP2255	A350
LFP2255	A4731SP
LFP2257	A447
LFP2261	A113
LFP227	A14302PLUS
LFP2270	A494E
LFP2285	A408SP
LFP2285XL	A408SP
LFP2286	A3786SP
LFP2286XL	A3786SP
LFP2288	A777CSP
LFP2288	A777SP
LFP2292	AR17
LFP2292	AR17
LFP2299	AR17
LFP2320	A22SP
LFP2339	A7041SP
LFP2339	A7041SP
LFP2339	A205SP
LFP2440	A1403SP
LFP25	A11
LFP25	A12
LFP251F	A1212SP
LFP251F	A23L39
LFP251F	A23L39SP
LFP2535	A010
LFP2535	A105SP
LFP255F	A1212SP
LFP2820	A20
LFP2820	A20PLUS
LFP29	A11
LFP29	A1428

LUBERFINER	PARTMO
LFP299	AR17
LFP3	A50
LFP3000	A3000SP
LFP3000	A3000SP
LFP3000XL	A3000SP
LFP3191	A67SP
LFP3191XL	A67SP
LFP3301	A43SP
LFP3301F	A43SP
LFP3307	A7028SP
LFP3328	A267
LFP3411	A267
LFP3692F	A23L39
LFP3692F	A23L39SP
LFP3830	A1402
LFP3854	A23L39
LFP3854	A23L39SP
LFP3855	A46SP
LFP3855	A888
LFP3871	A129SP
LFP3900	A427SP
LFP3943	AL106
LFP3970	A7177SP
LFP4005	A69SP
LFP4005HE	A69SP
LFP4005XL	A69SP
LFP4104	A349SP
LFP42	A243004SP
LFP431F	A150F
LFP431F	A150F
LFP431F1	A150F
LFP440F	A1P2299
LFP440F	A1P2299
LFP449	A91T1
LFP47	A111
LFP47	A43S
LFP5010	A291
LFP5016F	A85
LFP51	A83910
LFP5120	A7223SP
LFP5120B	A7223SP
LFP54	A48SP
LFP5522	A73
LFP5570	A9N5570SP
LFP566	PM343
LFP5757	A7125
LFP5760	A7105SP
LFP5760	A7105SP
LFP5822	A160
LFP5822	A160PLUS
LFP5823	A85
LFP5853	A16242SP
LFP5925	A1480
LFP5925001627705	A1480
LFP5964	A2700SP
LFP5964	A2700SP
LFP5969	A4271SP
LFP5969	A4271SP
LFP5971	A7029SP
LFP5971	A7029SP
LFP6007	A9N6007SP
LFP6015	A7898SP

LUBERFINER	PARTMO
LFP6241	A299E
LFP670	A116SP
LFP670HE	A116SP
LFP670SC	A116CSP
LFP670XL	A116SP
LFP680	A116SP
LFP693	A588C
LFP725	AR29SP
LFP734	A205SP
LFP777	A777CSP
LFP777	A777SP
LFP777A	A777CSP
LFP777A	A777SP
LFP777B	A777CSP
LFP777B	A777SP
LFP777XL	A777CSP
LFP777XL	A777SP
LFP780	A339SP
LFP780XL	A339SP
LFP781	A129SP
LFP781	A840SP
LFP784	A134
LFP791	A54SP
LFP805	A28SP
LFP815F	A96
LFP815FN	A96
LFP816	A97
LFP816F	A97
LFP816F	A97SP
LFP816FN	A97
LFP816FN	A97SP
LFP8235	A9003SP
LFP8244	A350
LFP8295	A7018
LFP832	A84SP
LFP8416	A350
LFP8501	A7133
LFP8509	A1
LFP8509	A1SP
LFP8537	A232SP
LFP8538	A232SP
LFP8591	A67SP
LFP8597	A325SP
LFP8642	A7685SP
LFP8643	A777CSP
LFP8643	A777SP
LFP8654	AA5374
LFP8704	A4049SP
LFP8752	A7028SP
LFP8939	A4052SP
LFP9000	A9080SP
LFP9001	A9080SP
LFP9001XL	A9080SP
LFP9007	A9080SP
LFP9008	A9080SP
LFP9025	A9025SP
LFP9035	A9035SP
LFP911	A116SP
LFP911	A3612ASP
LFP911HE	A116SP
LFP911XL	A116SP
LFP925F	A46SP
LFP925F	A888

LUBERFINER	PARTMO
LFP928F	A97C
LFP936F	A96C
LFP944F	A1285DSP
LFP947	A010
LFP947	A105SP
LFP966	A14302PLUS
LFP966	A20
LFP966	A20PLUS
LFP966	A223
LFP9930	A092SP
LFP9930	A28SP
LFP9930	A299E
LFW2055	AW2016SP
LFW2127	AW2127SP
LFW4013	AW2016SP
LFW4016	AW2010SP
LFW4022	AW2022SP
LFW4071	AW5137SP
LFW4071	AW5137SP
LFW4072	AW5137SP
LFW4073	AW2010SP
LFW4074	AW2010SP
LFW4422	AW2022SP
LFW4740	AW5137SP
LFW4744	AW5137SP
LFW4860	AW475SP
LFW4860XL	AW475SP
LFW5141	AW2237SP
LFW5870	AW2016SP
LFWP1242	A1259SP
LFWP2600	A1204SP
LG1	PFG516K
LG133	PM210
LG516	PFG516K
LH8755	A70015SP
LH95414	A91T1
LK100D	A3612ASP
LK102C	A15
LK103CA	A1P2299
LK103CA	A1P2299
LK106CR	A1P2299
LK106CR	A1P2299
LK110C	A15
LK111C	A15
LK111C	A3612ASP
LK112C	A3612ASP
LK113C	A3612ASP
LK122D	A3612ASP
LK135C	A3612ASP
LK136C	A3612ASP
LK137C	A3612ASP
LK138D	A3612ASP
LK139D	A3612ASP
LK13C	A3612ASP
LK140D	A3612ASP
LK144D	A3612ASP
LK145D	A3612ASP
LK14C	A3612ASP
LK150D	A3612ASP
LK152D	A3612ASP
LK153D	A3612ASP
LK154D	A3612ASP
LK159D	A3612ASP

LUBERFINER	PARTMO
LK162D	A495SP
LK164D	A495SP
LK168D	A3612ASP
LK175CA	A614
LK178D	A3612ASP
LK188C	A1226
LK192D	A3612ASP
LK193N	A3627
LK197C	A3612ASP
LK19C	A3612ASP
LK201D	A495SP
LK203CA	A614
LK210D	A3612ASP
LK213CA	A1P2299
LK213CA	A1P2299
LK21C	A3612ASP
LK23C	A3612ASP
LK27C	A15
LK27C	A3612ASP
LK282MB	PP7761
LK285C	A7766SP
LK2C	A15
LK30C	A3612ASP
LK33C	A3612ASP
LK341M	A7656E
LK34C	A15
LK34C	A3612ASP
LK35D	A3612ASP
LK3C	A15
LK3C	A3612ASP
LK40C	A15
LK40C	A3612ASP
LK42C	A3612ASP
LK45C	A3612ASP
LK46C	A15
LK46C	A3612ASP
LK55D	A3612ASP
LK60C	A3612ASP
LK69C	A15
LK69C	A3612ASP
LK71D	A3612ASP
LK86D	A3612ASP
LK88D	A3612ASP
LK94D	A3612ASP
LK98T	A15
LM15	PM210
LM30	PM17
LM66	PM17
LM71	PM17
LP129	PM174
LP132	PM197
LP134	PM210
LP164	PM9M9740
LP2	PM174
LP2029	PP7199
LP2182	PP24811
LP2210	PM17
LP2224	PM4031840025
LP2234	A48SP
LP2235	PM4031840025
LP2236	PM17
LP2254	PM0011843925
LP2256	PM1878100752

LUBERFINER	PARTMO
LP255F	A1212SP
LP3	PM3
LP30	PM17
LP49	PM245
LP5048	PP7230SP
LP52	PM126
LP5578	PM1650
LP5600	PM126
LP566	PM343
LP5902	PM9885132652
LP613	PM248
LP71	PM17
LP72	PM313
LP76	PM210
LP772	PM813
LP7FF	PM210
LP8700	PP7199
LP8741	PP9452
LP87411	PP9452
LP8912	PM7572
LP8995	PP7230SP
LP8995	PP7761
LP92	PM192
LP92HD	PM192
P1051	PP95785
P1069	PP80215
P2	PM174
P3	PM3
P3040	PP15466
P3040	PP4780
P3244	PP8088
P49	PM245
P52	PM126
P5609	PP6705
P71	PM17
P72	PM313
P76	PM210
P772	PM813
P7FF	PM210
P8153	PP7181
P823	A14302PLUS
P829	PP50361
P843	PP40425
P847	PP7196
P850	A50
P856	PP5562
P92	PM192
P960	PP6
P972	PP57061
P978	PP358
P979	PP7406
P980	PP4024
P981	PP85674
P990	PP79744
PB50	A50
PC301	A50
PH12	A11
PH12	A12
PH1218	A1428
PH1218R	A1428
PH16	A20
PH16	A20PLUS
PH181001	AP3707

LUBERFINER	PARTMO
PH1A	A1
PH2005	A1406
PH2005	A14476
PH2055	A4051SP
PH227K	A113
PH232	A20
PH232	A20PLUS
PH24	A33
PH25	A11
PH25	A12
PH253	A20
PH253	A20PLUS
PH253	AR1218
PH2700	A73
PH2700	A73PLUS
PH28	A243
PH2801	A4044
PH2801	A73
PH2802	A323
PH2802	A52
PH2802	A53PLUS
PH2805	A323
PH2805	A323PLUS
PH2805	A52
PH2805	A53PLUS
PH2807	A20
PH2807	A20PLUS
PH2808	A53PLUS
PH2808	A52
PH2809	A4044
PH2811	A091AE
PH2811	A4046
PH2816	A18
PH2816	A18PLUS
PH2820	A20
PH2820	A20PLUS
PH2820A	A20
PH2820A	A20PLUS
PH2821	A4041
PH2821A	A14476
PH2821A	A18
PH2821A	A18PLUS
PH2821A	A4041
PH2822	A113
PH2823	A1406
PH2823	A1406PLUS
PH2823	A14476
PH2825	A113
PH2827	A113
PH2830	A20
PH2830	A20PLUS
PH2832	A20
PH2832	A20PLUS
PH2835	A14302PLUS
PH2835	A14302PLUS
PH2835	A223
PH2840	A14476
PH2840	A14476PLUS
PH2843	A142SP
PH2849	A73
PH2849	A73PLUS
PH2851	A142SP
PH2852	A091AE

LUBERFINER	PARTMO
PH2856	A73
PH2856A	A4044
PH2856A	AR9
PH2858	A14302PLUS
PH2858	A14302PLUS
PH2858	A223
PH2861	A178PLUS
PH2861	A178SP
PH2862	A54SP
PH2863B	A2863B
PH2863B	A2863SP
PH2865	AR9
PH2867	A1402
PH2867	A1402PLUS
PH2868	A58
PH2868	A58PLUS
PH2868	A58T
PH2869	A52
PH2869	A53PLUS
PH2876	A58
PH2891	A178PLUS
PH29	A11
PH29	A1428
PH2903	A4056
PH299	AR17
PH37	A111
PH3942	A323
PH3942	A3603
PH3942	A3603PLUS
PH400	A243
PH4005	A69SP
PH449	A91T1
PH453	A1
PH47	A111
PH47	A9797PLUS
PH48	A160
PH48	A160PLUS
PH500	A52041SP
PH51	A4011
PH51A	A4011
PH561	A178PLUS
PH561	A178PLUS
PH59	A1432
PH610	A15403
PH6714	A343
PH675	A299E
PH7014	A14302PLUS
PH7024	A243
PH7028	A58
PH725	AR29SP
PH786	A091AE
PH787	A4052SP
PH820	A329
PH820M	A329
PH832	A84SP
PH8A	A1
PH8A	A1SP
PH920	A91480
PH922	A1432
PH933	A48SP
SD3	A20
SD3	A20PLUS
TP1287	A23

MANN & HUMMEL	PARTMO
7194	A178PLUS
18115	AP2941
59507	PM126
59517	PM126
92082	A2863SP
92082	A350
405174	APC203252
440560	PM17
446104	PM3
485949	AP101246K
499074	A69SP
515027	A1
528374	APCA502
659574	PM324
659574	PM324E
661874	AP2291
688739	PM325
692304	A23
694292	AP4M9378
760142	PM4031840025
760424	PM4031840025
760590	PM707
760590	PM707E
806887	PM192
901000	A840SP
901069	AP101275K
902705	PM28S1Z
963304	PM707
963304	PM707E
963510	PMX750R
964372	A1226LSP
964468	A1226LSP
988580	AP25867
988585	APC203252
988596	AP2291
988662	AP87658
988689	A23
988692	PMX750R
988732	A23
988739	A23
988765	AP4091
988768	PM4031840025
991111	PM813
991116	P346P
3003477	A7028SP
4278774	AP2291
5032483	AP7242
5151274	AP25867
5500274	A243004
5500574	A178PLUS
5500874	A840SP
10654074	A7028SP
11481186	A243004
11781186	A840SP
13306974	AP3542
24151017	A267
24650040	A840SP
26929540	PM17
29504356	AP2291
43262100	AP2291
43262500	APC203252

MANN & HUMMEL	PARTMO
43264500	APC203252
811250375	A1226LSP
811250375	A33358
4463001040	PM3
4463001040	PM3
4500555109	AP2489
4514557104	AP3988
4520055360	AP3543
4520257114	AP3542
4530056114	AP3920
4530092911	AP3920
4530092911	AP3921
4530092941	AP3920
4530092941	AP3921
4530292921	AP3920
4530292921	AP3921
4533755100	AP3544P
4533755110	AP3545
4550056124	APC20500
4565055149	AP4091
4565092304	AP2291
5000041045	A7028SP
5512503015	PP204030
6740358366	A243
6750259236	A20
6750259236	A20
6750259236	A20PLUS
6750259236	A20PLUS
6750359310	A1R0751SP
6750558336	A840SP
6750558476	A840SP
6750559016	A840SP
7002080492	PFG516K
7211141150	A178PLUS
7701016560	P346P
8083040048	AP2291
8108205005	AP2291
8125030021	PM28S1Z
8125030053	PM28S1Z
8183040040	AP2291
51055006073	PP7196
51055040039	PM4031840025
51055040044	PM4031840025
51055040046	PM4031840025
51055040047	PM4031840025
51055040066	A69SP
51055040067	A69SP
51055040069	PM4031840025
51055040070	PM4031840025
51055040071	PM4031840025
51055040087	PM4031840025
51055040090	PM4031840025
51055040090	PM4031840025
51055040104	PM4031840025
51055040105	PP7196
51063610002	AW2016SP
51125030004	A1226LSP
51125030005	A33358
51125030009	A1226LSP
51125030016	A1226LSP
51125030016	A33358
51125030018	A33358
51125030018	PM28S1Z

MANN & HUMMEL	PARTMO
51125030028	A1226LSP
51125030029	A1226LSP
51125030030	A1226LSP
51125030031	A1226LSP
51125030031	A33358
55505504007	A777SP
55508304013	AP4129908
55508304019	APCA502SY
55512503011	PM325
56084040501	APCA502SY
81000000238	PM4031840025
81000000238	PM4031840025
81000000244	PM707
81000000244	PM707
81000000244	PM707E
81000000244	PM707E
81000000246	PM28S1Z
81000000246	PM28S1Z
81055040008	PM17
81055040016	PM313
81055040019	PM17
81055040019	PM17
81055040023	PM313
81055040029	PM17
81055040029	PM17
81055040031	PM4031840025
81055040039	PM4031840025
81055040041	PM4031840025
81055040048	PMX750R
81055040049	PMX750R
81055046008	PM17
81082050005	AP2291
81083040016	PM313
81083040040	AP2291
81083040041	AP2291
81083040048	AP2291
81083040057	AP2291
81083040058	APCA502SY
81083040060	AP2291
81083040063	AP4129908
81083040065	AP4091
81125030001	PM707
81125030001	PM707E
81125030010	PM17
81125030013	PM324
81125030013	PM324E
81125030014	PM707
81125030014	PM707E
81125030015	PM707
81125030015	PM707E
81125030016	PM707
81125030016	PM707E
81125030018	PM28S1Z
81125030019	PM324
81125030019	PM324E
81125030020	PM707
81125030020	PM707E
81125030021	PM28S1Z
81125030022	PM28S1Z
81125030023	PM324
81125030023	PM324E
81125030028	PM324
81125030028	PM324E

MANN & HUMMEL	PARTMO
81125030036	PM707
81125030036	PM707
81125030036	PM707E
81125030037	PM324
81125030037	PM324E
81125030038	P346P
81125030040	PM707E
81125030041	PM707
81125030041	PM707E
81125030042	PM28S1Z
81125030043	PM324
81125030043	PM324E
81125030043	PM707
81125030043	PM707E
81125030045	PF6516K
81125030048	PM28S1Z
81125030050	PM324
81125030050	PM324E
81125030051	PM707
81125030051	PM707E
81125030052	PM28S1Z
81125030054	PM28S1Z
81125030056	PF6516K
81125030057	PF6516K
81125030058	PF6516K
81125030063	PM28S1Z
82125030038	P346P
86120006009	P346P
86779400377	A15
86779400377	A23
88055040001	PM17
88183040040	AP2291
88801161118	PM17
90101161188	PM17
90801161188	PM17
1.56084E+11	APCA502SY
8.11205E+11	PM28S1Z
W71295	A14302PLUS
WP12121	A3000SP
059517X	PM126
05P181137	AP2291
1159088S01	A9N5570SP
1224737S01	AP3542
250129620B	AP5627
330F10401	PM28S1Z
366E10402	PM17
366E10402	PM17
51.12503.0012	A243004SP
59517X	PM126
62115561A	AL106
62115561A	AL106
81125030023	PM324
81125030023	PM324E
A0854975700	P346P
A5000041045	A1
A5000041045	A267
A5008340004	AP25867
A6854975700	P346P
ARS1189	AP72152
BF31003	PM28S1Z
BF34901	PM707
BF34901	PM707E
BF37003	PM707

MANN & HUMMEL	PARTMO
BF37003	PM707E
BF37004	PM707
BF37004	PM707E
BF37104	PM325
BF700	PM324
BF700	PM324E
BF700X	PM324
BF700X	PM324E
BF707	PM324
BF707	PM324E
BF811	PM325
BF900X	PM325
BF917X	P346P
BFPU707X	PM707E
BFU700SCI	PM324
BFU700SCI	PM324E
BFU700X	PM324
BFU700X	PM324E
BFU707	PM324
BFU707	PM324E
BFU707SCI	PM324
BFU707SCI	PM324E
BFU900X	PM325
C 27 798	AP182028
C 27 830	AP5627
C1040	AP4M9379
C11007	APG6000
C1122	AP87658
C1134	AP3709
C11340	AP3709
C11455	AP3709
C11455	AP3709
C1150	AP3709
C1188	AP101275K
C1188x	AP101275K
C1258	AP4129908
C1281	AP4129908
C13103	AP16546
C13145	AP3988
C131452	AP3988
C13149	AP3988
C13380	AP3709
C13572	AP16546
C1369	AP3709
C13690	AP3709
C1371	AP4M8048
C13801	AP410
C14011	AP9S001
C14179	AP101222K
C14179	AP101222K
C14179	AP4000
C141793	AP101222K
C141793	AP101222K
C141794	AP101222K
C141794	AP101222K
C14190	AP2360
C142001	AP3542
C142001	AP3542
C142021	AP3542
C142102	AP3542
C1430	AP63680
C151653	APG4800
C151653	APG4800

MANN & HUMMEL	PARTMO
C151657	APG4800
C151657	APG4800
C15176	AP2621
C15260	APG4800
C15300	AP3920
C153003	AP3920
C16006	AP2959
C16110	AP05113
C16113	AP1087
C16133	AP2825
C161341	AP35893
C161341	AP35893
C16140	AP4M9335
C16148	AP3193
C1618	AP35733
C16190	AP101246K
C16190X	AP101246K
C162471	AP1908233
C16901	AP101246K
C17006	AP35844
C17126	AP106775
C17149	AP106775
C17237	AP31874
C17308	AP17308
C17337	AP3544P
C173372	AP3544P
C17400	AP46530
C18103	AP35921
C18149	AP3270
C181491	AP3270
C18301	AP7242P
C18378	AP46530
C18436	AP25867
C18436	AP25867
C184501	AP8280
C184502	AP8280
C18581	AP3554
C18581	AP3554
C18582	AP3554
C1881	AP4129908
C1891	AP3932
C19157	APCA502SY
C19171	APCA502SY
C1924	AP3176
C1980	AP142
C20002	AP35844
C20131	AP58010
C20164	AP45020
C2029	AP3144
C203252	APC203252
C203253	APC203252
C20326	AP2712
C20457	AP20457
C20500	APC20500
C20500	APC20500
C2055	AP1292
C2074	AP31551
C21001	AP35961
C21001	AP35961
C21104	AP35672
C21317	AP101234K
C21361	AP3128
C21361	AP3128

MANN & HUMMEL	PARTMO
C21383	AP3137
C21383	AP3137
C2150	AP3578
C2159	AP35672
C2159	AP3578
C22015	AP31820
C22024	AP35892
C2214	AP4495
C2219	AP4494
C22199	AP54180
C22212	AP1861
C2223	AP561
C22267	AP67030
C2229	AP3563
C22300	AP4M9378
C2262	AP3179
C2295	AP6293
C22952	AP35786
C22952	AP35786
C22952	AP35786
C23005	AP7242
C23018	AP31962
C23018	AP31962
C23021	AP31461
C23041	AP311019
C23107	APC010
C23129	AP355344
C23168	AP1861
C2324	AP3196
C2326	AP31592
C2330	AP3117
C2332	AP3118
C23326	AP4M8047
C2335	AP31564
C234401	AP41702
C23610	APC23610
C236103	APC23610
C2368	AP31550
C23795	AP31550
C23814	AP2688
C24005	AP31801
C24011	AP3115
C24012	AP356020
C24015	AP2690
C240152	AP2690
C24019	AP31905
C24028	AP350990
C24032	AP35783
C24034	AP35960
C24196	AP4001
C2420	AP3132
C24331	AP35750
C24331	AP35750
C24332	AP35750
C24332	AP35750
C2437	AP25867SY
C2438	AP3138
C24430	AP812105
C24441	AP4M8047
C24444	AP4M8047
C244441	AP4M8047
C24503	AP2291
C24503	AP2291

MANN & HUMMEL	PARTMO
C24523	AP2863
C24553	AP14210
C245532	AP14210
C24567	AP31928
C24578	AP2863
C2463	AP3511
C24642	AP3736
C24650	AP2291
C246501	AP2291
C246501	AP2291
C246506	AP2291
C246508	AP2291
C2469	AP31678
C2469	AP35790
C24700	AP3565
C2477	AP603A
C25002	AP311005
C250081	AP31992
C25016	AP31100
C25019	AP3108
C25101	AP3561
C25114	AP35644
C251141	AP35644
C25115	AP35887
C2512	AP3561
C2513	AP31653
C2514	AP3114
C25148	AP23009
C2524	AP3123
C2531	AP4337
C2535	AP3568
C2538	AP3561
C2542	AP31652
C25421	AP25867
C25522	AP31559
C25522	AP31559
C25522	AP3509
C25522	AP3509
C2559	AP1375
C2564	AP31521
C2565	AP31521
C25654	AP31950
C2568	AP3142
C25711	AP1275
C25711	AP1275
C2580	AP31559
C2580	AP3509
C26008	AP31832
C26012	AP35961
C26014	AP31744
C26015	AP3568
C26022	AP31832
C26032	AP3107
C26048	AP35645
C26100	AP3557
C26106	AP3537
C261101	AP35645
C261101	AP35645
C26120	AP31976
C2617	AP3102
C2619	AP31528
C2619	AP31555
C2620	AP31628

MANN & HUMMEL	PARTMO
C2626	AP31528
C2628	AP29400
C2631	AP3108
C26321	AP31588
C2637	AP25867SY
C2645	AP4337
C26451	AP3124
C26451	AP3124
C2652	AP4337
C2656	AP3582
C2666	AP35606
C26721	AP0978
C2676	AP3565
C2679	AP3567
C2681	AP3514
C26814	AP182028
C26816	AP182028
C27002	AP31773
C27003	AP31788
C270031	AP31788
C27014	AP31747
C27019	AP31899
C27030	AP35968
C2711706	AP4959
C2713203	AP84457
C271340	AP84457
C271340	AP84457
C271397	AP117797
C2714	AP2510
C27311	AP3133
C27311	AP3133
C2735	AP31697
C2775	AP29400
C27830	AP5627
C27830	AP5628
C27844	AP2425
C2791	AP3501
C28010	AP31797
C28011	AP31796
C28035	AP31980
C28040	AP31985
C28100	AP35594
C281012	AP25653
C281361	AP2021
C281361	AP2021
C28145	AP35594
C28200	AP1312
C2821	AP3130
C2826	AP31585
C2841	AP3109
C28561	AP1312
C28960	AP5021
C29008	AP3191
C29010	AP25653
C29019	AP31920
C29020	AP31984
C29108	AP35793
C291101	AP35645
C291262	AP1323
C291263	AP1323
C29144	AP35590
C29168	AP35800
C2941	AP3112

MANN & HUMMEL	PARTMO
C2942	AP323
C29624	AP4M9334
C296241	AP4M9334
C29631	AP626
C2964	AP1312
C2974	AP1312
C2975	APC301251
C29920	AP110558
C29939	AP110558
C29985X	AP35607
C29985X	AP35607
C30011	AP31963
C30017	AP31900
C30024	AP31935
C301251	APC301251
C301251	APC301251
C30130	AP3513
C301622	AP72152
C30171	AP3599
C3022	AP3129
C3028	AP3450
C30323	AP31622
C3033	AP3112
C30421	AP1294
C30421	AP1294
C310031	AP35781
C310031	AP35781
C31007	AP3134
C31008	AP3113
C311011	AP3129
C311011	AP3129
C311226	APCA502
C3112261	APCA502
C3112261	APCA502
C31126	AP3135
C3113451	AP49064
C311390	APCA502
C311521	AP35815
C311522	AP35815
C311522	AP35815
C31226	APCA502
C32005	AP3134
C32010	AP35781
C32013	AP35781
C32014	AP31753
C321541	AP35781
C321911	AP35758
C321911	AP35758
C3220	AP3111
C3233	AP3140
C323381	AP3570
C3260	AP3129
C33006	AP35886
C33007	AP35741
C33017	AP35977
C33156	AP3517
C3324	AP31700
C3366	AP4439
C341300	AP3518
C341500	AP9961
C3415001	AP9961
C341600	AP2654
C3468	AP35843

MANN & HUMMEL	PARTMO
C34681	AP35843
C34681	AP35843
C3485	AP35843
C34851	AP35843
C34852	AP35843
C34852	AP35843
C34852	AP35941
C34852	AP35941
C34852C	AP35843
C34852C	AP35843
C35004	AP3116
C35177	AP35939
C36005	AP35933
C36013	AP3146
C36020	AP31936
C36110	AP3571
C37153	AP35591
C37153	AP35665
C371531	AP35591
C371531	AP35591
C371531	AP35665
C371531	AP35665
C3725	AP3125
C3766	AP31624
C381631	AP1368
C381631	AP1368
C421404	AP3838
C42871	AP31785
C42872	AP31785
C42872	AP31785
C4312	AP3570
C4312	AP35756
C43121	AP3570
C43121	AP35756
C43121	AP35756
CF 1400	AP137640
CF 1520	AP5628
CF1000	APC203252SY
CF1020	AP46531
CF1030	AP46531
CF1122	AP87658
CF1200	AP41702SY
CF1281	AP114215145
CF1300	AP4091
CF1300SY	AP4091
CF1313	AP821884
CF1398	AP3737
CF1414	AP14220
CF15121	AP114215145
CF1520	AP5628
CF1552	AP5628
CF1593	AP3722
CF16140	AP4M9379
CF16219	AP4416
CF1651	AP84457SY
CF1711	AP72154
CF300	AP3921
CF3001	AP3921
CF3001	AP3921
CF500	APC20500SY
CF5001	APC20500SY
CF6001	APC23610SY
CF610	APC23610SY

MANN & HUMMEL	PARTMO
CF751	AP2489
CF751X	AP2489
CF850	AP3543
CF8502	AP3543
CF933	AP20457SY
CF990	AP3545
CF9902	AP3545
CR791	AP3501
CU1719	AP31002
CU1829	AP31090
CU19002	AP31006
CU19006	AP43100
CU1910	AP31055
CU1910	AP31743
CU1919	AP31071
CU1919	AP31081
CU20010	AP31019
CU2012	AP25700
CU2138	AP31026
CU22004	AW5137SP
CU22007	AP31088
CU220192	AP31068
CU22028	AP31123
CU22032	AP31071
CU22032	AP31138
CU22142	AP31012
CU2227	AP31033
CU2227	AP31033
CU23019	AP43100
CU2330	AP39649
CU2331	AP31042
CU2331	AP31043
CU2336	AP31739
CU24004	AP31054
CU24009	AP31096
CU24013	AP31043
CU2442	AP71191
CU25003	AP31097
CU25012	AP31097
CU26017	AP31029
CU2622	AP40878
CU2623	AP31060
CU27009	AP31136
CU2733	AP33893
CU2746	AP31015
CU2842	AP31631
CU2945	AP31063
CU32010	AP35781
CU3318	AP31798
CU3569	AP31084
CU3596	AP31084
CU3858	AP31001
CU3858	AP31035
CUK1919	AP31081
CUK2442	AP71191
CUK2733	AP33893
CUK2742	AP33893
CUK3858	AP31035
CX11349	AP3191
E90KP D164	PM4094
EK404	PM28S1Z
EX404	PM28S1Z
FO1826364	A1SP

MANN & HUMMEL	PARTMO
FO584	A14302PLUS
FP7514	A4047
H10105X	PM197
H1012T	PM174
H10291N	A33
H1032	PM174
H1032M	PM174
H1034	PM313
H10342X	PM313
H10343	PM313
H1034X	PM313
H1038	PM313
H1038X	PM313
H1048	PM192
H1048T	PM192
H1053N	PM17
H10671	PM197
H10671X	PM197
H10671Z	PM197
H107211X	PM9M9740
H107211X	PM9M9740
H11106	PM197
H12105NLUB	PM197
H12105XLUB	PM197
H12109	PM4031840025
H121102	PM4031840025
H121102X	PM4031840025
H121102X	PM4031840025
H121102X	PM4031840025
H121102X	PM4031840025
H121103	PM4031840025
H12111	PM0011843925
H12125	PM4031840025
H13153	PM343
H19326X	PMX750R
H711	PM126
H712N	PM313
H7271	PP40425
H7271X	PP40425
H7371X	PP40425
H80499	PM126
H804N	PM126
H804T	PM126
H804X	PM126
H81699	PM126
H816T	PM126
H816V	PM126
H816X	PM126
H820	PM813
H8203	PM813
H8203X	PM813
H9161X	P346P
H9221X	PM210
H9251X	PM210
H9281	PM245
H9281T	PM245
H928T	PM245
H951H	PP7196
H951X	PP7196
HU1012	PP7230SP
HU10771X	PP10771SP
HU10771Z	PP10771SP
HU10772X	PP10771SP
HU12110X	PP7230SP

MANN & HUMMEL	PARTMO
HU12140X	PP12140
HU6006Z	PP4024
HU6007X	PP8088
HU6009Z	PP79744
HU6011Z	PP62442
HU6013z	PP6013Z
HU6019Z	PP85674
HU611X	PP6705
HU6122X	PP85674
HU6122X	PP85674
HU612X	PP4780
HU618X	PP62442
HU691	PP8088
HU691	PP8088
HU692X	PP8088
HU692X	PP8088
HU7001X	PP3C30A
HU7002Z	PP16328
HU7008Z	PP15562
HU7009z	PP31060
HU7019Z	PP31060
HU7112	PP6
HU7112	PP6
HU71151X	PP358
HU7115X	PP358
HU7126x	PP80125
HU7127x	PP80111
HU7128X	PP92425
HU7128X	PP92425
HU7181K	PP7181
HU7182X	PP27000
HU718X	PP27000
HU7196N	PP15466
HU7196N	PP15466
HU7196x	PP7399
HU7196x	PP7399
HU7197X	PP15466
HU7197X	PP15466
HU7214X	PP1072
HU7214X	PP1072
HU722X	PP1072
HU722Y	PP1072
HU7262X	PP5562
HU7262X	PP5562
HU726X	PP5562
HU7271X	PP40425
HU7271X	PP40425
HU816X	PP1053
HU818X	PP13376
HU818X	PP52001SP
HU8191x	PP2200C
HU8191X	PP2200C
HU8225X	PP27401
HU8225X	PP27401
HU825X	PM2200
HU825X	PP2200
HU923X	PP72321
HU9254X	PP27908
HU9254X	PP27908
HU9315	PP7199
HU9315X	PP7199
HU9315X	PP7199
HU9316X	PP7199

MANN & HUMMEL	PARTMO
W11685	A309SP
W1170	A349SP
W117015	A309SP
W117015	A349SP
W117016	A349SP
W11703	A840SP
W1184	A116SP
W12102	A495SP
W12106	A116SP
W12110	A116SP
W12205	A205SP
W12205	A7533SP
W1228	A2700SP
W1228	A2700SP
W1237X	A91T1
W1262	A205SP
W1294	A116CSP
W1294	A116SP
W1294	A3612ASP
W131452	A69SP
W1323	AL106
W31480	A323
W431	PF6516K
W4310	PF6516K
W436	PF6516K
W6021	A14616
W6025	A58
W610	A1402
W6101	A1406
W6101	A14476
W6103	A1402
W6103	A1402PLUS
W6106	A1402
W6106	A73
W6107	A58
W61080	A1406
W61080	A14476
W61081	A73
W61082	A1402
W61082	A1402
W61082	A1402PLUS
W61082	A1402PLUS
W61083	A1406
W61083	A14476
W61083	A14476
W6109	A1406
W6109	A1406
W6109	A14476
W671	A58
W672	A14478PLUS
W6780	A58
W6781	A14476
W6781	A14476
W6781	A14476PLUS
W6781	A14476PLUS
W6781	A14478PLUS
W6781	A14478PLUS
W681	A14476
W683	A14476
W6880	A14476
W6880	A14476
W6880	A14476PLUS
W6880	A14476PLUS

MANN & HUMMEL	PARTMO
W7020	A14302PLUS
W7030	A160
W7030	A160PLUS
W7032	A3603PLUS
W7041	A113
W7053	A091AE
W70561	A160PLUS
W711	A18
W711	A18PLUS
W711	A223
W71180	A14302PLUS
W71180	A14302PLUS
W712	A18
W712	A18PLUS
W712	A20
W712	A20PLUS
W7120	A14476
W71215	A4011
W71218	A323
W71219	A14476
W7122	A14302PLUS
W71220	A18PLUS
W71221	A14302PLUS
W71222	A111
W7124	A18
W7124	A18
W7124	A18PLUS
W7124	A18PLUS
W7124	A18PLUS
W71243	A14302PLUS
W71254	A14302PLUS
W71254	A14302PLUS
W7126	A14302PLUS
W7126	A18
W7126	A18
W7126	A18PLUS
W7126	A18PLUS
W71273	A14302PLUS
W71275	A9797PLUS
W7128	A091AE
W71282	A4056
W71283	A14302PLUS
W71298	A14302PLUS
W713	A18
W713	A18PLUS
W713	A20
W713	A20PLUS
W71314	A178PLUS
W71319	A14302PLUS
W71336	A14302PLUS
W7135	A14476
W7135	A20
W7135	A20PLUS
W7139	A178PLUS
W718	A113
W718	A178PLUS
W7182	A14302PLUS
W719	A092SP
W71912	A178PLUS
W71913	A14302PLUS
W71914	A178PLUS
W71915	A178PLUS
W71925	A178PLUS
W71925	A178PLUS

MANN & HUMMEL	PARTMO
W71927	A243
W71930	A178PLUS
W7194	A178PLUS
W7194	A178PLUS
W71945	A15403
W71945	A15403
W7195	A178PLUS
W7195	A178PLUS
W7199	A73
W71999	A18
W71999	A18
W71999	A18PLUS
W71999	A18PLUS
W7231	A330C
W752	A3603
W752	A3603
W752	A3603PLUS
W752	A3603PLUS
W7522	A3603
W7522	A3603
W7522	A3603PLUS
W7522	A3603PLUS
W753	A3603
W753	A3603
W753	A3603PLUS
W753	A3603PLUS
W753	A4044
W8005	A22SP
W8005	A267
W8006	A1
W80061	A1
W8013	A4044
W8017	A52
W81180	A4044
W81180	A52
W81184	A113
W81185	A52
W81299	A323
W81299	A52
W81299	A52
W81299	A53PLUS
W81299	A53PLUS
W8130	A1
W81383	A73
W8130	A14302PLUS
W81480	A73
W81481	A113
W81499	A113
W81499	A113
W815	A4044
W81580	A4044
W81680	A091AE
W81780	A73
W81882	A113
W81882	A113
W81883	A52
W81884	A14302PLUS
W81899	A73
W820	A091AE
W840	A091AE
W87	A323
W9053	A9N5570SP
W9103	A4044

MANN & HUMMEL	PARTMO
W91413	A4044
W91414	A52
W9142	A20
W9142	A20
W9142	A20PLUS
W9142	A20PLUS
W91428	A329
W91428	A329
W9143	A4044
W9161	A20
W9161	A20
W9161	A20PLUS
W9161	A20PLUS
W91797	A73
W920	A7028SP
W920110	A20
W920110	A20PLUS
W920110	A20
W920110	A20PLUS
W920110	AR1218
W920150	A20
W920150	A20PLUS
W920150	A20
W920150	A20PLUS
W920150	AR1218
W92016	A329
W92017	A18
W92017	A18
W92017	A18PLUS
W92017	A18PLUS
W92019	A14302PLUS
W9202	A14302PLUS
W92020	A20
W92020	A20PLUS
W92020	AR1218
W92021	A20
W92021	A20PLUS
W92021	AR1218
W92025	A4044
W92020	A14302PLUS
W9204	A20
W9204	A20PLUS
W9204	AR1218
W92047	A4044
W92048	A20
W9205	A73
W9206	A20
W9206	A20PLUS
W9206	AR1218
W92080	A20
W92080	A20
W92080	A20PLUS
W92080	A20PLUS
W92080	A7028SP
W92082	A2863SP
W92082	A2863SP
W92082	A350
W92099	A20
W92099	A20PLUS
W92121	A20
W92121	A20PLUS
W92121	AR1218
W92180	A2863B

MANN & HUMMEL	PARTMO
W92180	A2863SP
W92180	A350
W92180	A350
W9231	A20
W9231	A20PLUS
W924	A20
W924	A20PLUS
W9251	A70015SP
W928	A11
W92880	A7029SP
W9293	A9N5570SP
W930	A7028SP
W93011	A091AE
W93015	A16242SP
W93015	A48SP
W93020	A1
W93021	A1
W93026	A092SP
W93026	A1480
W93020	A14302PLUS
W9307	A7028SP
W9308	A20
W9308	A20PLUS
W931	A50
W93280	A1
W9343	A1428
W9343	A1428
W935	A1428
W93599	A20
W93599	A20
W93599	A20PLUS
W93599	A20PLUS
W936	A1
W9364	A26SP
W9364	A26SP
W93640	A26SP
W93640	A26SP
W9365	A11
W9365	A1428
W9365	A1428
W9368	A11
W938	AR17
W940	A267
W9401	A1
W94013	A1
W94015N	A267
W94015N	A267
W94017X	A15
W94022	A1
W94030	A427SP
W94034	A427SP
W94049	A1
W94081	A1
W9501	A48SP
W9501	A48SP
W95013	A48SP
W95013	A48SP
W95014	A48SP
W95016	A339SP
W95017	A299E
W95017	A48SP
W95018	A339SP
W95018	A339SP

MANN & HUMMEL	PARTMO
W95026	A7898SP
W95039	A7898SP
W9505	AR17
W9506	A7898SP
W9507	AR17
W9508	A4863
W951	A7177SP
W962	A840SP
W96211	A349SP
W96214	A840SP
W96228	A840SP
W96247	A840SP
W96260	A840SP
W9628	A840SP
W96280	AR17
W96280	AR17
WA1144	AW2022SP
WA9190	AW2016SP
WA9231	AW5137SP
WA9232	AW2010SP
WA9233	AW5137SP
WA9235	AW2010SP
WA9401	AW5137SP
WA94010	AW2010SP
WA94015	AW475SP
WA9406	AW5137SP
WA9407	AW2010SP
WA9409	AW2237SP
WA956	AW2016SP
WA9561	AW2010SP
WA9MULTI1116	AW5137SP
WD13009X	A91T1
WD13125	A69SP
WD131451	A69SP
WD14004	A408SP
WD94010	A70015SP
WD9402	A54SP
WD9402	A54SP
WD9402	A83910
WD95026	A7898SP
WDK111021	A8059
WDK1110223	A8059
WDK1110223	A8059
WDK1110225	A8059
WDK1110227	A8059
WDK111029	A8059
WDK9621	A7653
WDK9621	A7653
WDK96216	A1218
WDK9628	A7653
WF422	PFG516K
WF916	A20
WF916	A20PLUS
WF9161	A20
WF9161	A20PLUS
WF91610	A14302PLUS
WF92020	A14302PLUS
WF9622	A48SP
WK 723	A33358
WK 8044 x	A1226ISP
WK 94012	A1894
WK10002	AS27177JSP
WK100021X	AS27177JSP

MANN & HUMMEL	PARTMO
WK10017X	AS1003SP
WK10017x	AS1003SP
WK1030	AS1441SP
WK1040	ASV1040SP
WK10401X	ASV60TSP
WK10401X	ASV60TSP
WK1042X	ASV60TSP
WK10501	ASV1060SP
WK10501	ASV1060SP
WK1060	ASV1060SP
WK10601	ASV90TSP
WK10601X	ASV90TSP
WK10602	AR90D
WK10602	ASR90TSP
WK10604	ASV1060SP
WK10604	ASV1060SP
WK10605X	AR90D
WK10605X	AS1441SP
WK10606X	ASR90TSP
WK10807x	AS46018SP
WK11001X	AS11001SP
WK11015X	ASR45SP
WK11025	A614
WK11025	A614
WK111025	A614
WK111025	A614
WK111025	A85
WK111027	A7657
WK111027	A7657
WK1124	A830
WK11421X	AS1441SP
WK1142X	AS1441SP
WK1149	A7927SP
WK1162	A4618310
WK1164	A4618310
WK1168	A4618310
WK1179	A7656E
WK12002	AS1040SP
WK1270	AS1040SP
WK295	PFG516K
WK31	PFG516K
WK314	PFG516K
WK317	PFG516K
WK3X	A1212SP
WK413	PFG323
WK421	PFG516K
WK4210	PFG805
WK4210	PFG805
WK431	PFG516K
WK5013	PFG25121074
WK510	PFG1400
WK5111	PFG25121074
WK5111	PFG25121074
WK512	PFG25121074
WK512	PFG330
WK5122	PFG25121074
WK5122	PFG25121074
WK551	PFG3191125000
WK551	PFG3191125000
WK552	PFG25121074
WK552	PFG25121074
WK553	PFG25121074
WK553	PFG25121074

MANN & HUMMEL	PARTMO
WK553	PFG330
WK56	PFG1163
WK58	PFG25121074
WK6002	PFG323
WK612	PFG3191125000
WK6121	PFG3191125000
WK6121	PFG3191125000
WK6123	PFG423
WK6124	PFG1196
WK6125	PFG481I
WK6125	PFG481I
WK6126	PFG3191125000
WK6126	PFG3191125000
WK6126	PFG516K
WK6132	PFG423
WK6132	PFG423
WK61411	PFG423
WK61415	PFG335
WK61419	PFG405
WK61419	PFG405
WK61441	PFG367
WK61441	PFG367
WK61446	PFG25121074
WK61446	PFG25121074
WK6183	PFG423
WK66	PFG1104
WK68	PFG3191125000
WK7162X	A1226
WK7162X	AS200SP
WK7182	A11213DSP
WK7196	A33358
WK720	PFG1195
WK723	A243004
WK723	A33358
WK7231	A243004
WK7231	A7533DSP
WK7236	A243004
WK7236	A33358
WK7266	A243004
WK7301	A243004DSP
WK731	A243004
WK731	A33358
WK733	A243004
WK7380	PFG1105
WK757	A33358
WK782	PFG872
WK782	PFG872
WK79	PFG1105
WK7980	PFG1105
WK7980	PFG1105
WK8001	A330C
WK8002	A4053SP
WK8003	A33358
WK8018X	A7533DSP
WK8019	AS201SP
WK8081	A4047
WK81186	A4053SP
WK81186	A4054SP
WK812	A4047
WK8128	AS7784D
WK814	A1226
WK815	A093DSP
WK81580	A4053SP

MANN & HUMMEL	PARTMO
WK81580	A4053SP
WK815X	A093DSP
WK816	A1226
WK81880	A292
WK8194	A4053SP
WK8194	A4053SP
WK82018	PFG469
WK821	A1226LSP
WK8241	AS201SP
WK8242	AS201SP
WK828	A7533DSP
WK828	A7533SP
WK828X	A7533DSP
WK8293	PFG391
WK8293	PFG391
WK8296	PFG391
WK830	PFG1195
WK8307	PFG1195
WK8307	PFG1195
WK831	PFG1195
WK836	A1226LSP
WK842	A1226
WK842	A1226LSP
WK84216	A1226
WK8422	A1226
WK8422	A1226
WK8422	A1226LSP
WK8425	A1226
WK8425	A1226
WK8427	A1226LSP
WK8503	A1R0751SP
WK851	PFG7958
WK8533X	PFG7958
WK8534	PFG7958
WK8541	AS200SP
WK8546	AS200SP
WK8546	AS200SP
WK9016	PFG454
WK9017X	AS1003SP
WK9024	PFG453
WK9043	PFG448
WK9150	AR16SP
WK9165X	A787
WK9171	A3726
WK9201	A4886
WK9203	A305F
WK9203	A305F
WK923	A15
WK9232X	A1204SP
WK9252	A787
WK9263X	A15
WK9322	A23
WK933X	A1204SP
WK93915	PFG448
WK93915	PFG448
WK94010	A1894
WK94011	A4886
WK94012	A1894
WK94016	A4886
WK94016x	A4886
WK9402	A1894
WK9402	A1894
WK94022	A1CSP

MANN & HUMMEL	PARTMO
WK94022	A7533DSP
WK94024	A1204SP
WK94026	AS4654SP
WK94033	AS4654SP
WK94033	AS4654SP
WK94033X	AS4654SP
WK94036X	AS1249SP
WK94037X	A093SP
WK94042	A1894
WK9406	A7533SP
WK9407	A787
WK941	A70015SP
WK95012	A97
WK95013	A1P2299
WK95013	A1P2299
WK95013	A1P2299
WK95013	A1P2299
WK95014	AS950SP
WK95016	A1212SP
WK95016X	A1212SP
WK95016X	A15
WK95016X	A23
WK9502	A1212SP
WK95020	A1212SP
WK95021	A7813SP
WK95021	A7813SP
WK95026X	A1259SP
WK9503	A1P2299
WK9503	A1P2299
WK9503	A1P2299
WK9503	A1P2299
WK9503	A1P2299
WK9504	A4618310
WK9521	A1R0751SP
WK9552	A23
WK960	A7813SP
WK96211	A96
WK96213	A1006SP
WK96213	A1006SP
WK96217	A46SP
WK96217	A888
WK96218	A23L39
WK96218	A23L39SP
WK9627	A7653
WK9627	A7653
WK965	A1259SP
WK965X	A1259SP
WK980	A614
WP1026	A91480
WP1045	A7028SP
WP1102	A7685SP
WP11023	A7685SP
WP11023	A7685SP
WP1144	A232SP
WP1168	A232SP
WP1169	A325SP
WP12001	A9080SP
WP12120	A9080SP
WP121201	A9080SP
WP12121	A3000SP
WP12300	A3000SP
WP1240	A2700SP
WP1240	A2700SP
WP1240	A7041SP

MANN & HUMMEL	PARTMO
WP1270	A777CSP
WP1270	A777SP
WP1290	A777CSP
WP1290	A777SP
WP1295	A777CSP
WP1295	A777SP
WP91480	A91480
WP91480	A91480
WP92080	A4271SP
WP9263X	A15
WP9263X	A23
WP9263X	A23
WP9263X	A23SP
WP9263X	A23SP
WP92880	A7029SP
WP92880	A7029SP
WP92881	A092SP
WP92882	A7029SP
WP92882	A7029SP
WP92882	A7029SP
WP92882	A7029SP
WP92882	A7029SP
WP931	A50
WP93110	A50
WP93110	A50
WP940	A1
WP9623X	A1212SP
WP9623X	A15
WP9623X	A15
WP9623X	A23
PREMIUM	PARTMO
ACP001	AP31001
ACP002	AP31002
ACP003	AP31060
ACP006	AP31006
ACP007	AP31739
ACP010	AP31631
ACP011	AP25700
ACP012	AP31012
ACP013	AP39649
ACP014	AP71191
ACP015	AP31015
ACP017	AP31017
ACP019	AP31019
ACP024	AP31055
ACP026	AP31026
ACP028	AP31028
ACP029	AP31029
ACP030	AP31030
ACP032	AP31032
ACP033	AP31033
ACP035	AP31035
ACP036	AP31036
ACP037	AP31037
ACP042	AP31042
ACP043	AP31043
ACP046	AP31043
ACP047	AP43042
ACP050	AP31743
ACP054	AP31054
ACP063	AP31063
ACP064	AP31064
ACP065	AP31065
ACP068	AP31068

PREMIUM	PARTMO
ACP070	AP31070
ACP071	AP31071
ACP081	AP31081
ACP084	AP31084
ACP088	AP31088
ACP090	AP31090
ACP096	AP31096
ACP097	AP31097
ACP100	AP43100
ACP102	AP31102
ACP106	AP31033
ACP108	AP43100
ACP123	AP31123
ACP136	AP31136
ACP138	AP31138
AIP1000	AP31500
AIP1001	AP311001
AIP1002	AP311002
AIP1005	AP311005
AIP1007	AP311007
AIP1008	AP13190
AIP1008INT	AP13190SY
AIP1015	AP3736
AIP1017	AP5213
AIP1017int	AP5213SY
AIP1018	AP99322
AIP1019	AP311019
AIP1020	AP311020
AIP1024	APG6000
AIP1027	AP3988
AIP1028	AP311028
AIP1029	AP4000
AIP1031	AP3708
AIP1032	AP311032
AIP1033	AP311033
AIP1034	AP2206
AIP1035	AP311035
AIP1036	AP311036
AIP1050	AP99727
AIP1051	AP48772
AIP1053	AP25867
AIP1060	AP85051
AIP1061	AP3936
AIP1062	AP84457
AIP1078	AP39601
AIP1086	AP3565
AIP1097	AP3539
AIP1104	AP25653
AIP1109	AP23030
AIP1111	AP21413
AIP1117	AP93019
AIP1128	AP5M100
AIP1132	AP80006
AIP1132	KITAP80006 / AP80006SY
AIP1133	AP2299
AIP1151	AP1126
AIP1151INT	AP1126SY
AIP1152	AP80220
AIP1152INT	AP80220SY
AIP500	AP1347
AIP501	AP3563
AIP502	AP4494

PREMIUM	PARTMO
AIP503	AP561
AIP504	AP3568
AIP505	AP2510
AIP506	AP1375
AIP507	AP3578
AIP508	AP2600
AIP509	AP3178
AIP510	AP3176
AIP511	AP31511
AIP512	AP531
AIP513	AP3195
AIP514	AP537
AIP515	AP3533
AIP515M	AP3533
AIP516	AP3130
AIP517	AP5H100
AIP518	AP2884
AIP519	AP3170
AIP520	AP3511
AIP521	AP31521
AIP522	AP1365
AIP523	AP1305
AIP524	AP603A
AIP525	AP1371
AIP526	AP3540
AIP527	AP3105
AIP528	AP31528
AIP529	AP3128
AIP530	AP3603
AIP531	AP31531
AIP532	AP3170
AIP533	AP3179
AIP535	AP3135
AIP537	APL300
AIP538	AP3138
AIP539	AP142
AIP540	AP1861
AIP541	AP3133
AIP542	AP31542
AIP543	AP2877S
AIP543int	AP2877SY
AIP544	AP31544
AIP545	AP3574
AIP546	AP1323
AIP547	AP233
AIP548	AP1339
AIP549	AP3118
AIP551	AP31551
AIP552	AP3134
AIP553	AP35553
AIP554	AP1312
AIP554M	AP1312
AIP555	AP31555
AIP556	AP3124
AIP557	AP51557
AIP558	AP62010
AIP559	AP31559
AIP559	AP3509
AIP560	AP35606
AIP561	AP3581
AIP562	AP3121
AIP563	AP31563
AIP564	AP31564

PREMIUM	PARTMO
AIP565	AP3565
AIP566	AP3567
AIP567	AP3119
AIP568	AP3129
AIP569	AP3515
AIP570	AP45020
AIP571	AP3136
AIP572	AP146
AIP573	APSL40A
AIP574	AP3527
AIP575	AP3524
AIP576	AP1087
AIP577	AP3181
AIP578	AP16546
AIP579	AP3562
AIP580	AP2712
AIP580	AP2712A
AIP580INT	AP2712SY
AIP581	AP3932
AIP582	AP410
AIP583	AP3123
AIP584	AP1292
AIP585	AP31585
AIP586	AP3582
AIP588	AP31588
AIP589	AP2561
AIP590	AP35590
AIP591	AP35591
AIP592	AP31592
AIP593	AP3113
AIP594	AP35594
AIP595	AP101222K
AIP596	AP2863
AIP597	AP3501
AIP598	AP1368
AIP599	AP3519
AIP600	AP1275
AIP601	AP3578
AIP602	AP35602
AIP603	AP3570
AIP604	AP3114
AIP605	AP3137
AIP607	AP35607
AIP608	AP3513
AIP614	AP7242P
AIP615	AP6293
AIP616	AP31616
AIP617	AP3450
AIP619	AP2959
AIP620	AP3550
AIP621	AP1000
AIP622	AP31622
AIP623	AP58010
AIP624	AP31624
AIP626	AP3139
AIP627	AP3125
AIP628	AP31628
AIP629	APH100
AIP630	AP4001
AIP631	AP240
AIP632	AP3140
AIP633	AP3111
AIP633	AP3511

PREMIUM	PARTMO
AIP635	AP8040
AIP636	AP62636
AIP637	AP3142
AIP639	AP3707
AIP640	AP3102
AIP641	AP05113
AIP642	AP67030
AIP643	AP31643
AIP644	AP35644
AIP645	AP35645
AIP646	AP3531
AIP647	AP3536
AIP650	AP3532
AIP651	APC010
AIP652	AP31652
AIP653	AP31653
AIP655	AP3112
AIP656	AP3117
AIP658	AP3193
AIP659	AP9S001
AIP660	AP35660
AIP661	AP3132
AIP665	AP35665
AIP666	AP1298
AIP667	AP3554
AIP668	AP1294
AIP669	AP3709
AIP670	AP0978
AIP671	AP3561
AIP672	AP35672
AIP674	APC301251
AIP675	AP4000
AIP676	AP3143
AIP677	AP35677
AIP678	AP31678
AIP679	AP3196
AIP680	AP63680
AIP681	AP3115
AIP682	AP16550
AIP683	AP3109
AIP685	AP3500
AIP686	AP1330
AIP687	AP3108
AIP688	AP4495
AIP689	AP3588
AIP690	AP3122
AIP691	AP4439
AIP692	AP3599
AIP693	AP3557
AIP694	AP3116
AIP695	AP3193
AIP696	AP2021
AIP697	AP31697
AIP698	APG4800
AIP699	AP29400
AIP700	AP31700
AIP701	AP31701
AIP702	AP240
AIP705	AP384
AIP707	AP3107
AIP708	AP3144
AIP709	AP3120
AIP710	AP3190

PREMIUM	PARTMO
AIP711	AP31711
AIP712	AP5627
AIP713	AP5628
AIP714	AP17308
AIP714	AP20457
AIP715	APC203252SY
AIP716	APC23610
AIP717	APC23610SY
AIP718	AP3920
AIP719	AP3921
AIP722	AP17871
AIP723	AP7242
AIP724	AP4862
AIP725	AP4863
AIP726	AP78020
AIP730	APC20500
AIP733	AP35733
AIP734	AP31734
AIP736	AP35736
AIP741	AP35741
AIP744	AP31744
AIP745	AP4636
AIP746	AP4637
AIP747	AP31747
AIP748	AP5021
AIP749	AP51250
AIP750	AP35750
AIP751	AP3736
AIP752	AP3737
AIP753	AP31753
AIP754	AP3571
AIP755	AP35755
AIP756	AP35756
AIP757	AP2941
AIP758	AP35758
AIP759	AP3127
AIP760	AP95600906
AIP761	AP524344
AIP763	AP2224
AIP764	AP2216
AIP765	AP4416
AIP766	AA5374
AIP767	AP3145
AIP769	AP2825
AIP770	AP3270
AIP771	AP5203
AIP772	AP5217
AIP773	AP31773
AIP774	AP2520
AIP775	AP182028
AIP775A	AP137640
AIP775int	AP137640
AIP776	AP2825
AIP777	AP3146
AIP778	AP3514
AIP779	AP1202
AIP780	AP3537
AIP781	AP35781
AIP782	AP35782
AIP783	AP35783
AIP785	AP31785
AIP786	AP35786
AIP787	AP6A701

PREMIUM	PARTMO
AIP788	AP31788
AIP789	AP17871SY
AIP790	AP35790
AIP791	AP3191
AIP793	AP35793
AIP794	AP7242P
AIP795	AP31795
AIP796	AP31796
AIP797	AP31797
AIP798	AP31798
AIP800	AP35800
AIP801	AP31801
AIP802	AP3544P
AIP803	AP3545
AIP804	AP3518
AIP805	AP3518SY
AIP806	AP31806
AIP808	AP20457
AIP810	AP2205
AIP811	AP5A500
AIP814	AP23603
AIP815	AP35815
AIP816	AP117797
AIP817	AP203823
AIP818	AP57MD33
AIP819	AP2425
AIP820	AP31820
AIP821	AP14210
AIP822	AP14220
AIP823	AP2690
AIP826	AP1051
AIP828	AP31828
AIP831	AP2263
AIP832	AP31832
AIP834	AP31834
AIP837	AP31100
AIP840	AP35840
AIP843	AP35843
AIP844	AP35844
AIP845	AP1325
AIP845INT	AP1330E
AIP847	AP812105
AIP847INT	AP114215145
AIP849	AP110558
AIP853	APC203252
AIP856	AP2279
AIP857	AP31857
AIP859	AP2291
AIP859INT	AP4091
AIP860	AP31461
AIP860	AP31461
AIP861	AP31861
AIP862	AP35862
AIP863	AP1051
AIP865	AP2251
AIP870	AP2705
AIP871	AP2520H
AIP874	AP31874
AIP876	AP351833
AIP879	AP78090
AIP881	AP87657
AIP881INT	AP87658
AIP882	AP17845

PREMIUM	PARTMO
AIP882INT	AP17846
AIP883	AP2253
AIP884	AP2688
AIP884INT	AP2621
AIP885	AP350990
AIP886	AP35886
AIP887	AP35887
AIP889	AP356020
AIP890	AP3548
AIP890int	AP3722
AIP891	AP4129907
AIP892	AP35892
AIP893	AP35893
AIP895	AP3600
AIP898	AP35898
AIP899	AP31899
AIP900	AP31900
AIP901	AP355344
AIP903	AP31550
AIP904	AP31904
AIP905	AP31905
AIP906	AP1061
AIP907	AP4986
AIP910	AP31910
AIP912	AP352660
AIP914	AP2036
AIP914int	AP4036
AIP915	AP35915
AIP917	AP35917
AIP920	AP31920
AIP921	AP35921
AIP923	AP31923
AIP927	AP2217
AIP928	AP31928
AIP930	AP31930
AIP932	AP35932
AIP933	AP35933
AIP935	AP31935
AIP936	AP31936
AIP939	AP35939
AIP941	AP35941
AIP942	AP31942
AIP945	AP2520
AIP946	AP8054
AIP947	AP3838
AIP950	AP31950
AIP960	AP35960
AIP961	AP35961
AIP962	AP31962
AIP963	AP31963
AIP968	AP35968
AIP969	AP23009
AIP970	AP2231
AIP976	AP31976
AIP977	AP35977
AIP980	AP31980
AIP984	AP31984
AIP985	AP31985
AIP989	AP12020
AIP989INT	AP12020SY
AIP990	AP31990
AIP992	AP31992
FLP300	A7533DSP

PREMIUM	PARTMO
FLP300	A7533SP
FLP301	A4886
FLP301	A4886
FLP301	A570DSP
FLP301	A570DSP
FLP301	AK570SP
FLP301	AK570SP
FLP302	PFG25121074
FLP303	A941SP
FLP304	PFG1120
FLP305	PFG1191
FLP306	PFG1196
FLP308	PFG1195
FLP310	PFG1100
FLP311	PFG1104
FLP313	PFG872
FLP314	PFG314
FLP315	PFG3191102100
FLP316	PFG3191125000
FLP317	A4053SP
FLP319	PFG805
FLP320	A093DSP
FLP320	A093SP
FLP322	PM4094
FLP323	PFG323
FLP325	A3726
FLP325	A3726SP
FLP325C	A292
FLP330	PFG330
FLP331	PFG1163
FLP333	PFG0120490B
FLP334	PFG0120490B
FLP335	PFG335
FLP336	A8401
FLP337	PFG481I
FLP338	P346P
FLP340	A4054SP
FLP343	A243004
FLP343	A243004SP
FLP346	PFG44781
FLP348	A4023SP
FLP349	PFG516K
FLP352	PP78091
FLP352	PP78091SP
FLP353	A7602
FLP355	PP7355
FLP357	PFG357
FLP358	AS201SP
FLP360	AS46018SP
FLP361	PFG890
FLP363	AS7784D
FLP365	PP7735
FLP366	PFG3191105000
FLP367	PFG367
FLP368	PFG368
FLP370	A1CSP
FLP375	A3726
FLP380	PFG1105
FLP381	A1204SP
FLP383	PFG330
FLP384	A33358
FLP385	AS1441SP
FLP386	PM1940

PREMIUM	PARTMO
FLP387	A1212SP
FLP387	ASV1212SP
FLP388	A1CSP
FLP391	PFG391
FLP392	AS200SP
FLP395	PP176AC
FLP396	A243004DSP
FLP396	A243004DSP
FLP398	A5368SP
FLP400	PFG1400
FLP403	A941C
FLP404	P3461
FLP405	PFG405
FLP407	PP201010
FLP407	PP201030
FLP408	A7533C
FLP409	PM9760
FLP410	PP11682
FLP410	PP11682SP
FLP411	AS1249SP
FLP412	AS1282SP
FLP412	ASV1282SP
FLP414	A23
FLP414	A23SP
FLP416	A1345SP
FLP417	PP7751
FLP420	PFG420
FLP422	PFG422
FLP423	PFG423
FLP424	PP1112
FLP425	PFG7958
FLP426	AS18512SP
FLP429	PP202030
FLP430	AS4654SP
FLP432	PP28970
FLP433	AR90D
FLP433	ASR90TSP
FLP433	ASV90TSP
FLP434	A4886
FLP434	A570DSP
FLP434	AK570SP
FLP435	PP24811
FLP437	AS5850SP
FLP439	PM7680
FLP440	PP808010
FLP441	PM7680
FLP442	A43SP
FLP443	PP5706
FLP444	PP7444
FLP445	A23L39
FLP445	A23L39SP
FLP446	A588
FLP448	PFG448
FLP449	AS1228SP
FLP450	PP04041
FLP451	PM1730SP
FLP452	ASR90TDSP
FLP453	PFG453
FLP454	PFG454
FLP455	PP7455
FLP456	A7813SP
FLP460	PFG460
FLP463	PFG1163

PREMIUM	PARTMO
FLP464	AS1040SP
FLP465	PM19765SP
FLP467	PP19925
FLP468	PP80468
FLP470	PP7355
FLP471	PP7355
FLP472	PP80472
FLP473	PP22135
FLP476	PP7476
FLP481	PP71044
FLP483	A96
FLP484	A97
FLP487	A11213DSP
FLP489	AS1033SP
FLP490	A26000SP
FLP495	PP13110
FLP500	PP7777SP
FLP505	PPEV430
FLP506	PPEV470
FLPINT002	PFG1001
FLPINT003	PFG1C000
OLP001	A7029SP
OLP001	A7029SP
OLP002	A4271SP
OLP002	A4271SP
OLP002D	A4271SP
OLP002D	A4271SP
OLP004	A092SP
OLP005	A14476
OLP005	A14476PLUS
OLP006	A58
OLP006	A58PLUS
OLP006	A58T
OLP007	PP5562
OLP008	A1
OLP008	A1SP
OLP009	A28SP
OLP010	A111
OLP011	A142SP
OLP012	A52
OLP012	A53PLUS
OLP013	A2863B
OLP013	A2863SP
OLP014	A7041SP
OLP015	A18
OLP015	A18PLUS
OLP016	A73
OLP016	A73PLUS
OLP017	A339SP
OLP018	A3000SP
OLP018	A3000SP
OLP019	A1402
OLP019	A1402PLUS
OLP020	PP7181
OLP021	A4048SP
OLP022	A4049SP
OLP024	PP4024
OLP025	A48SP
OLP026	A67SP
OLP027	A116SP
OLP028	A53PLUS
OLP029	A105SP
OLP029	A205SP

PREMIUM	PARTMO
OLP030	A777SP
OLP031	PP6
OLP032	A7105SP
OLP034	PP7199
OLP035	A48SP
OLP036	A4052SP
OLP037	PP9452
OLP038	A2700SP
OLP039	A28SP
OLP039	A28SP
OLP040	PM2200
OLP040	PP2200
OLP041	PP6705
OLP043	PP50361
OLP046	PP27908
OLP047	A20
OLP047	A20PLUS
OLP048	A4050
OLP049	A1406
OLP049	A1406PLUS
OLP051	PP15466
OLP052	PP2200C
OLP053	A4044
OLP053	PP1053
OLP054	A4044
OLP055	A3603
OLP055	A3603PLUS
OLP056	A178PLUS
OLP057	PP4780
OLP058	A4051SP
OLP059	A291
OLP060	A26SP
OLP060	A26SP
OLP061	A11
OLP062	PP7196
OLP063	PP79744
OLP064	A4050
OLP064	A4050PLUS
OLP065	A113
OLP066	PP40425
OLP067	A14302PLUS
OLP067	A223
OLP068	PP358
OLP069	A3000SP
OLP072	PP1072
OLP074	PP57061
OLP075	PM1650
OLP076	PM2240
OLP077	A20
OLP077	A20PLUS
OLP078	PP2F000
OLP080	AC45
OLP081	A160
OLP081	A160PLUS
OLP082	A9080SP
OLP083	A7105SP
OLP084	PM4031840025
OLP086	PP3C30A
OLP087	PP13376
OLP088	PP8088
OLP089	PP27401
OLP090	A52041SP
OLP092	A427SP

PREMIUM	PARTMO
OLP093	PP62442
OLP094	PP72321
OLP097	PP15562
OLP098	A14616
OLP098	A14616PLUS
OLP099	PP85674
OLP100	PP88580
OLP101	A329
OLP105	A7898SP
OLP106	A14476
OLP106	A14476PLUS
OLP107	PP31060
OLP108	PP03009
OLP109	PP7399
OLP110	PP7406
OLP111	PP80111
OLP113	A15403
OLP114	A8720CSP
OLP115	PP16328
OLP116	A7898SP
OLP117	PP12010
OLP122	PP17356
OLP124	PP6013Z
OLP125	PP80125
OLP127	PP52001SP
OLP131	PP80215
OLP145	A408SP
OLP148	A7177SP
OLP153	A52041SP
OLP154	PP95785
OLP155	A3603PLUS
OLPXT005	A14476PLUS
OLPXT006	A58PLUS
OLPXT010	A9797PLUS
OLPXT012	A53PLUS
OLPXT019	A1402PLUS
OLPXT028	A323PLUS
OLPXT049	A1406PLUS
OLPXT054	A4044
OLPXT055	A3603PLUS
OLPXT056	A178PLUS
OLPXT067	A14302PLUS
OLPXT077	A20
OLPXT077	A20PLUS
OLPXT081	A160
OLPXT081	A160PLUS
OLPXT098	A14616PLUS
OLPXT113	A15403
WPF401	AW2010SP
SAKURA	PARTMO
1109101K80	AP31923
A 1177	AP78020
A1006	AP4M9379
A1013	AP5021
A1013	AP5021
A10134	AP5021
A1014	AP101222K
A1015	AP4337
A1016	AP3932
A10161	AP3932
A1019	AP2761
A10195	AP2761
A1022	APL300

SAKURA	PARTMO
A1023	AP4337
A1031	AP3500
A1034	AP3193
A1039	AP7242P
A1043	AP31528
A1044	AP31531
A1044	AP31861
A1045	AP31564
A1046	AP3138
A1047	AP3128
A1048	AP31563
A1050	AP7242
A1051	AP4337
A1053	AP3118
A1067	AP7242P
A1068	AP31624
A1081	AP31950
A1084	AP7242P
A1088	AP7242
A1090	AP311002
A1090	AP3118
A1092	AP3128
A1093	AP7242
A1112	AP1861
A1114	AP121
A1119	AP58010
A1123	AP3129
A1125	AP3142
A1126	AP10903
A1127	AP05113
A1128	AP54100
A1129	AP3124
A1130	AP31528
A1130	AP31555
A1135	AP1861
A1135	AP67030
A1138	AP31592
A1141	AP3193
A1143	AP67030
A1144	AP3123
A1145	AP3135
A1147	AP3179
A1148	AP3133
A1149	AP3170
A1150	AP3119
A1152	AP3136
A1156	AP3736
A1156S	AP3736
A1158	AP8040
A1161	AP67030
A1169	AP186
A1169	AP54180
A1174	AP3134
A1177	AP78020
A1178	AP31653
A1180	AP31628
A1193	AP31798
A1194	AP3125
A1196	AP62636
A1198	AP3134
A1219	AP3114
A1223	AP31643
A1307	AP2621

SAKURA	PARTMO
A1310	AP812105
A1313	AP2688
A1319	AP3737
A1320	AP13190SY
A1324	AP17871
A1324S	AP17871 / AP17871SY
A1325	AP1325
A1326	AP17871SY
A1330	AP1330E
A1335M	AP17845
A1336	AP17846
A1336M	AP17846
A1338	AP13190
A13530	AP80220
A13540	AP80220SY
A13570	AP78090
A13580	AP23030
A13590	AP23030SY
A1402	AP410
A1408	AP31511
A1410	AP142
A1413	AP537
A1414	AP3176
A1415	AP3178
A1416	AP3195
A1422	AP3181
A1423	AP31551
A1426	AP3588
A1431	AP31905
A1433	AP3117
A1433	AP3117
A14420	AP31928
A14450	AP311001
A14490	AP31905
A14520	AP31984
A1502	AP2825
A1503	AP101246K
A1507	AP1312
A1508	AP2884
A1515	AP16550
A1515	AP16550
A1517	AP3115
A1518	AP3143
A15251	AP352660
A1604	AP121
A1605	AP626
A1608	AP323
A1613	AP3137
A1621	AP1292
A1634	AP3139
A1643	AP31700
A1644	AP3139
A1647	AP63680
A1671	AP31773
A17011	AP3709
A1703	AP323
A1709	AP31585
A1713	AP3582
A1715	AP31559
A1715	AP3509
A1715	AP4337
A1717	AP35606

SAKURA	PARTMO
A17200	AP31899
A1730	AP3121
A1733	AP31622
A1734	AP31521
A1742	AP3511
A1757	AP3140
A1759	AP3140
A1762	AP3111
A1768	AP3109
A17830	AP31834
A17850	AP35782
A17990	AP31962
A1804	A20PLUS
A1812	AP16546
A1817	AP2825
A1818	AP1312
A18181	AP1312
A1828	AP2216
A1832	AP35733
A1833	AP3533
A1834	AP35553
A1836	AP3130
A1841S	AP5021
A1841S	AP51250
A1842	AP5021
A1844	AP31544
A1864	AP9S001
A1877	AP3132
A1878	AP3132
A1880	AP3127
A18900	APG4800
A18960	AP3270
A1930	AP1305
A1931	AP3562
A1932	AP6261
A1935	AP3574
A1938	AP6261
A1943	AP3557
A1952	AP35594
A1955	AP17308
A1959	AP35736
A1965	AP35755
A19880	AP35844
A19920	AP31992
A2002	AP1323
A2002	AP3123
A2003	AP3574
A2103	AP35843
A2217	AP4M9378
A22340	AP31874
A2306	AP3932
A2307	AP4337
A24240	AP35939
A2511	AP106775
A2539	AP4439
A25440	AP3554
A25930	AP3561
A2611	AP35590
A2621	AP3570
A2625	AP3570
A2705	AP821884
A2709S	AP14210 / A14220

SAKURA	PARTMO
A2802	AP1375
A2804	AP31559
A2804	AP3509
A2807	AP3567
A2808	AP2510
A2812	AP4001
A2813	AP5H100
A2816	AP2600
A2818	AP31678
A2818	AP35790
A2819	AP3565
A2820	AP31588
A2820	AP3565
A2821	AP31652
A2830	AP45020
A2839	AP3108
A2843	AP29400
A2844	AP3112
A2847	AP3144
A28510	AP3120
A28530	AP3532
A28530	AP78090
A28550	AP3107
A28560	AP2959
A28570	AP31697
A28590	AP3145
A28590	AP31832
A28600	AP31797
A28610	AP31796
A28620	AP31744
A28630	AP31747
A28640	AP31100
A28650	AP5A500
A28690	AP31820
A28760	AP31920
A28790	AP31936
A28820	AP311005
A28880	AP31985
A28890	AP31980
A28930	AP311033
A28950	AP35645
A28990	AP31900
A2908	AP31542
A2922	AP1323
A2923	AP31622
A2924	APSL40A
A2928	AP240
A2930	APH100
A2932	AP35660
A2933	AP3102
A2935	AP2959
A2936	AP3599
A29370	AP351833
A29440	APG6000
A3102	AP35815
A31080	AP35758
A31140	AP35781
A3301	AP31801
A3304	AP3116
A3308	AP3113
A3318	AP2825
A3320	AP31550
A3326	AP1861

SAKURA	PARTMO
A33410	AP35898
A33450	AP351160
A3370	AP2279
A33730	AP30070
A33740	AP35977
A33810	AP31753
A33850	AP3118
A33870	AP31806
A3601	AP35741
A38010	AP31711
A38050	AP5538
A38200	AP31861
A38210	AP1126
A38220	AP1126SY
A38370	AP31990
A38470	AP35915
A42610	AP21413
A44130S	AP4M9334
A44130S	AP4M9335
A4922	AP35917
A5001	AP2425
A5005	AP46530
A5006	AP46531
A5019	AP3515
A5020	AP2863
A5021	AP3501
A5023	AP3518
A5024	AP3518SY
A5025S	AP3518
A5025S	AP3518SY
A5105	APC20500
A5106	APC20500SY
A5301	AP41702
A5301	AP41702
A5311	AP4091
A5328	AP5627
A53380	AP3539
A5408	AP106775
A5428	AP2520
A5431	AP182028
A5435	AP137640
A5439	AP4863
A5440	AP4862
A5442	AP4637
A5443	AP4636
A5507	AP4M8047
A5507S	AP4M8048
A5508	AP4M8048
A5509	AP4M9334
A5510	AP4M9335
A5511	AP4M9378
A5512	AP4M9379
A5538	AP14220
A5538	AP14220
A5539	AP14210
A5540	AP3545
A5541	AP3544P
A5541	AP3544P
A55412	AP3544P
A5541S	AP3544P
A5541S	AP3545
A5553	AP7N1225
A5610	APCA502SY

SAKURA	PARTMO
A5613	APCA502SY
A5628	AP101246K
A5631	AP51250
A5666	AP2690
A5828	AP31788
A58300	AP31788
A5903	APC010
A6007	AP127312
A6008	AP4129908
A6012	AP2712
A6012	AP2712A
A6014	AP5203
A6014M	AP5203
A6018	AP5213
A6018	AP5213
A6019	AP5217
A6020	AP2877S
A6020M	AP2877S
A6026	AP5213SY
A6026	AP5213SY
A6036	AP3548
A6037	AP3548
A6038S	AP3548
A6038S	AP3548 / AP3722
A6114	AP5213SY
A6114	AP5213SY
A6118S	AP114215145
A6118S	AP812105
A6119	AP17845
A6120M	AP17846
A6127	AP16550
A61360	AP35750
A61380	AP31461
A61440	AP31461
A61500	AP3561
A61530	AP35961
A61640	AP61250
A6207	APC203252
A6210	AP41702SY
A6302	APC203252SY
A6303	AP2291
A6514	AP1339
A6520	AP3707
A6522	AP121
A6524	AP3707
A6530	AP35591
A6530	AP35665
A6540	AP3191
A65430	AP3537
A65490	AP350990
A65540	AP356020
A65620	AP35960
A65660	AP351833
A6604	AP1323
A6707	APC23610
A6708	APC23610SY
A6815	AP1323
A68390	AP4971SY
A7003	AP3542
A7004	AP3543
A7103	AP78605
A7106	AP2690

SAKURA	PARTMO
A7122	AP49064
A7124	AP9961
A7128	AP49064SY
A7607	AP51250
A7623	AP3544P
A76510	AP80006SY
A76520	AP80006
A76520	KITAP80006 / AP80006SY
A7913	AP87658
A7918	AP4000
A7967	AP4416
A7972	AP2660
A8505	AP3988
A8506	AP3542
A8506S	AP3542
A8506S	AP3543
A8507	AP3737
A8508	AP3736
A8513	AP3716
A8548	AP2S600
A8553	AP3920
A8553S	AP3921
A8565	AP3543
A8604S	AP3736 / AP3737
A8633	AP1063
A8645	AP12020
A8646	AP12020SY
A8681	AP2705
A8902	AP3196
A8903	AP3450
A8904	AP4495
A89080	AP3146
A9216	AP2576
AF4278	AP1312
AF545	AP4416
AS1010	AP101234K
AS1014	AP101222K
AS1031	AP3500
AS1034	AP3193
AS1201	AP3193
AS1502	AP2825
AS22470	AP8280
AS22470	AP8280
AS5628	AP101246K
AS5628S	AP101246K
AS7918	AP4000
C1001	A4044
C10011	A73
C10012	A091AE
C10013	A4044
C1002	A323
C1002	A52
C10022	A323
C10028	A323
C1003	AR9
C10031	A323
C10032	A4044
C10034	A4044
C1004	A2863B
C1004	A2863SP
C1005	A091AE

SAKURA	PARTMO
C10051	A091AE
C1006	A291
C1007	A1403SP
C1008	A092SP
C1008	A28SP
C10081	A092SP
C10082	A092SP
C10083	A092SP
C10085	A092SP
C1009	A9N6007SP
C1010	A4271SP
C1011	A1402
C10113	A1402
C1012	A7028SP
C1012	A7028SP
C1012	A7028SP
C1013	A4044
C1025	A4044
C1028	A58PLUS
C1030	A1402
C1034	A092SP
C1041	A58
C1045	A1480
C1101	A113
C1102	A20
C1102	A20PLUS
C11022	A20
C11022	A20PLUS
C11022	AR1218
C11025	A20
C11025	A20PLUS
C11031	A178PLUS
C11033	A113
C1104	A1
C1104	A1SP
C11041	A1
C11061	A1
C1107	A14476
C1109	A14476
C1109	A14476
C1109	A14476
C11091	A14476
C11095	A14476
C1110	A14302PLUS
C11103	A14302PLUS
C11104	A14302PLUS
C11105	A14302PLUS
C11106	A14302PLUS
C11108	A14302PLUS
C11109	A14302PLUS
C1111	A91480
C11112	A91480
C11113	A91480
C11114	A91480
C1112	A7029SP
C1112	A7029SP
C11122	A7029SP
C11122	A7029SP
C11123	A7029SP
C11123	A7029SP
C11124	A7029SP
C11124	A7029SP
C11125	A7029SP
C11125	A7029SP

SAKURA	PARTMO
C11126	A7029SP
C11126	A7029SP
C1113	A1406
C1113	A14476
C11131	A1406
C11131	A14476
C11132	A1406
C11132	A14476
C11133	A1406
C11133	A14476
C11135	A1406
C11135	A14476
C1114	A14302PLUS
C11141	A14302PLUS
C11144	A14302PLUS
C1116	A1480
C1118	A91480
C1119	A14476
C11193	A14302PLUS
C1121	A1
C1121	A1SP
C1123	A14302PLUS
C1123	A20
C1123	A20PLUS
C1126	A14302PLUS
C1139	A14476
C1141	A14302PLUS
C1142	A14302PLUS
C1151	A1406
C1153	A14302PLUS
C12021	A14476
C1204	A14478PLUS
C1207	A091AE
C1208	A091AE
C1218	A14478PLUS
C1301	A105SP
C1301	A7041SP
C1302	A1480
C1302	A1480
C1303	A7105SP
C1304	A7105SP
C1304	A7105SP
C1305	A205SP
C1306	A777CSP
C13061	A777CSP
C13061	A777SP
C1309	A010
C1309	A105SP
C1314	A7105SP
C1314	A7105SP
C1316	A7105SP
C1317	A2210SP
C1318	A4048SP
C1320	A2210SP
C1323	A4048SP
C1327	A777CSP
C1327	A777SP
C1328	A4048SP
C13320	A1402
C1404	A1406
C1501	A142SP
C1503	A2863SP
C1504	A4052SP

SAKURA	PARTMO
C1505	A9N6007SP
C1507	A2863B
C1507	A2863SP
C1508	A4051SP
C1511	A2863SP
C1511	A350
C15111	A2863SP
C15111	A350
C1513	A205SP
C1514	A111
C1515	A2700SP
C1515	A2700SP
C1515	A2700SP
C1515	A7041SP
C1516	A4271SP
C1516	A4271SP
C1516	A4317SP
C15161	A4271SP
C15161	A4271SP
C15171	A73
C1519	A2700SP
C1519	A2700SP
C1525	A50
C1527	A8720L
C15271	A8720CSP
C1533	A205SP
C1534	A2700SP
C1539	A4050
C1544	A205SP
C1546	A4271SP
C1546	A4271SP
C1552	A43S
C1561	A205SP
C1562	A2700SP
C1562	A2700SP
C15671	A8720CSP
C1601	A323
C1602	A73
C1605	A323
C1605	A52
C16051	A52
C16052	A52
C1701	A323
C1701	A73
C17011	A4044
C1704	A4049SP
C1706	A4048SP
C1712	A4271SP
C1713	A73
C1717	A7144SP
C17181	A092SP
C1720	A091AE
C1721	A1402
C1723	A14302PLUS
C1726	A4317SP
C1735	A4317SP
C17390	A14302PLUS
C1801	A113
C18022	A178PLUS
C1805	A113
C18051	A113
C18052	A113
C18053	A113

CRUCE DE REFERENCIAS

SAKURA	PARTMO
C18054	A113
C18056	A113
C18058	A113
C1807	A97C
C1809	A58
C18093	A58
C18094	A58
C18096	A58
C1814	A1406
C1814	A14476
C18141	A1406
C18141	A14476
C1815	A52
C18151	A52
C18152	A52
C18155	A52
C1818	A113
C1820	A113
C1821	A1402
C1821	A1402PLUS
C1823	A58
C1823	A58PLUS
C1828	A243
C1829	A113
C1832	A4044
C1834	A1
C18640	A3603PLUS
C18670	A52
C1901	A354
C1903	A20
C1903	A20PLUS
C1904	A129SP
C1908	A329
C19083	A329
C1909	A243
C19093	A178PLUS
C1915	A178PLUS
C1922	A329
C1936	A14302PLUS
C2105	A4056
C2107	A091AE
C21990	A4056
C2204	A14476
C22041	A14476
C24011	A20
C24011	A20PLUS
C24011	AR1218
C2501	A223
C2505	A3603
C2516	A3603
C25171	A3603
C2803	A4044
C28031	A323
C2804	A58PLUS
C2805	A58PLUS
C2807	A178PLUS
C2808	A1402
C2810	A28SP
C28160	A9035SP
C2906	A092SP
C2906	A7028SP
C3001	A14476
C31090	A14302PLUS

SAKURA	PARTMO
C31110	A4056
C38090	A7383SP
C38100	A329
C4905	A840SP
C5002	A3786SP
C5102	AR17
C5105	A408SP
C5205	A58
C52100	A840SP
C5301	A309SP
C5403	A7028SP
C5501	A67SP
C55011	A67SP
C5502	A69SP
C55021	A69SP
C5503	A9N5570SP
C55031	A9N5570SP
C5504	A54SP
C5505	A9N6007SP
C5510	A67SP
C56021	A7223SP
C5604	A16242SP
C56042	A16242SP
C5701	A116SP
C57012	A116SP
C5702	A777SP
C57022	A777CSP
C57022	A777SP
C57023	A777CSP
C57023	A777SP
C57025	A777CSP
C57025	A777SP
C5703	A427SP
C5704	A339SP
C5706	A3000SP
C57061	A3000SP
C5707	A3000SP
C5707	A3000SP
C5710	A9080SP
C5713	A7898SP
C5715	A116SP
C5717	A777CSP
C5717	A777SP
C5718	A777CSP
C5718	A777SP
C5720	A777CSP
C5720	A777SP
C5808	A7028SP
C5808	A7028SP
C5816	A7028SP
C6001	A205SP
C6101	A840SP
C6102	A9003SP
C6104	A7018
C6105	A1403SP
C6106	A1403SP
C61120	A20
C61120	A20PLUS
C6204	A840SP
C6205	A178PLUS
C6206	A178PLUS
C62063	A178PLUS
C62064	A178PLUS

SAKURA	PARTMO
C62066	A178PLUS
C6210	A48SP
C6211	A14302PLUS
C6402	A14302PLUS
C6502	A11
C65021	A33
C65022	A11
C65023	A11
C65032	A11
C65033	AP147
C6504	A11
C6504	A1428
C65041	A11
C650410	A11
C650410	A1428
C65044	A11
C65044	A1428
C65048	A11
C65048	A1428
C6505	A111
C65051	A111
C65052	A111
C6507	A4011
C6508	A010
C6508	A105SP
C6510	A18
C65112	A4011
C6519	A4044
C6520	A495SP
C65201	A495SP
C6526	A1432
C65400	A14616
C6601	A267
C6602	A1
C6603	A20
C6603	A20PLUS
C66031	A14302PLUS
C66032	A113
C6701	A111
C67014	A111
C67015	A111
C67016	A111
C6804	A178SP
C7001	A267
C7005	A116SP
C7005	A3612ASP
C7008	A349SP
C7602	AR29SP
C7910	A26SP
C7910	A26SP
C7917	A22SP
C7923	A2863SP
C7923	A350
C7929	A178PLUS
C7937	A232SP
C7940	A113
C79401	A4044
C7971	A160
C7971	A160PLUS
C7972	AL106
C7982	A4044
C7988	A810
C80015	A1

SAKURA	PARTMO
C80041	A4044
C8013	A4011
C8014	A20
C8014	A20PLUS
C8014	AR1218
C80141	A20
C80141	A20PLUS
C80141	AR1218
C8015	A267
C80162	A20
C80162	A20PLUS
C8017	A48SP
C8019	A54SP
C8024	A092SP
C8030	A1402
C8032	A14302PLUS
C8033	A091AE
C8037	A1
C8043	A178PLUS
C8044	A1406
C8044	A14476
CA1112	AP31071
CA1114	AP31071
CA1114	AP31081
CA1115	AP31071
CA11300	AP31071
CA14050	AP31026
CA1705	AP31033
CA17160	AP31096
CA17190	AP31071
CA1806	AP31090
CA1809	AP31060
CA18190	AP31088
CA18320	AP31060
CA18360	AP31097
CA18361	AP31097
CA18390	AP31071
CA19250	AP31032
CA19250	AP43100
CA2803	AP31006
CA2807	AP31739
CA2808	AP31055
CA2808	AP31743
CA28160	AP31043
CA28210	AP31012
CA28300	AP31029
CA28380	AP31739
CA28380	AP43100
CA54010	AP43042
CA65180	AP40878
CA65210	AP71191
CA65220	AP31019
CA65300	AP31030
CA65310	AP31032
CA79200	AP31037
CA79210	AP31036
CAC1114	AP31071
CAC1114	AP31081
CAC1115	AP31071
CAC112	AP31071
CAC2807	AP31739
CAC28210	AP31012
CAC30020	AP31743

SAKURA	PARTMO
CAC65190	AP39649
CAV1112	AP31071
CAV1114	AP31071
CAV1115	AP31071
CU20008	AP31088
EF1003	PP22135
EF11110	PP1112
EF1112	PP1112
EF1301	PP11690SP
EF13020	PP04041
EF13021	PP04041
EF13070	PP78091
EF13070	PP78091SP
EF13100	PP11682
EF13100	PP11682SP
EF13110	PP13110
EF13180	PPEV570
EF1509	PP28970
EF15130	PP24811
EF15130	PP24811
EF15131	PP24811
EF1802	PP11682
EF1802	PP11682SP
EF18050	PP80472
EF18060	PP18060
EF2634	PP7761
EF2636	PP7735
EF65030	PP71044
EO1102	PP31060
EO1103	PP4024
EO11050	PP4024
EO11060	PP7406
EO13070	PP78140
EO1501	PP88580
EO1701	PP6
EO17030	PP16328
EO1801	PM2200
EO1801	PP2200
EO1802	PP2200C
EO1803	PP2200C
EO1804	PP2200
EO18060	PP62442
EO18210	PP62442
EO18230	PP18230SP
EO2101	PP4780
EO2404	PP9452
EO24070	PP358
EO2501	PP6705
EO2621	PP12140
EO2624	PP40425
EO2626	PP7199
EO2628	PP7196
EO2801	PP27000
EO2804	PP57061
EO2805	PP27401
EO28060	PP3C30A
EO28070	PP2F000
EO28090	PP52001SP
EO2903	PP7196
EO29050	PP03009
EO30140	PP1053
EO3101	PP5562
EO3103	PP15466

SAKURA	PARTMO
EO31070	PP7399
EO31110	PP15562
EO31950	PP80125
EO38010	PP12010
EO5311	PP7196
EO54010	PP2620SP
EO6506	PP7196
EO6507	PP8088
EO65090	PP85674
EO65090	PP85674
EO65120	PP80215
EO66010	PP79744
EO8301	PP7319SP
ES57010	PP19925
F1103	A4053SP
F1110	PP7751
F1111	PP7355
F11112	PP7355
F11130	PP7444
F11140	PP7476
F11141	PP78260
F1303	PM988511911
F13031	PM988511911
F1306	PM1940
F13140	PPEV430
F13150	PPEV470
F1503	PM9760
F1504	PM1878100270
F1507	PM1940
F1803	PM1878100270
F1805	PM1878100271
F25020	PM4094
F2601	PM707
F2601	PM707E
F2602	PM707
F2602	PM707E
F26021	PM324
F26021	PM324E
F26022	PM324
F26022	PM324E
F26023	PM707
F26023	PM707E
F26024	PM324
F26024	PM324E
F2603	PM325
F2604	PM28S1Z
F26041	PM28S1Z
F26300	PM28S1Z
F5602	PM28S1Z
F7302	PM126
FC1001	A4886
FC1001	AK570SP
FC1002	A292
FC1002	A305F
FC1002	A3726
FC1002	A3726SP
FC10022	A292
FC10022	A3726SP
FC1003	A3726
FC1004	A292
FC1005	A56670
FC10051	A56670
FC1006	A093DSP

SAKURA	PARTMO
FC1007	A4047
FC1009	A093SP
FC1012	A292
FC1012	A3726SP
FC1020	A292
FC1020	A305F
FC1020	A3726
FC1020	A3726SP
FC1101	A4053SP
FC1102	A4053SP
FC1104	A7533DSP
FC1104	A7533SP
FC1105	A7533DSP
FC1105	A7533SP
FC1106	A4047
FC1107	A4047
FC1108	A7533DSP
FC1201	A4047
FC1201	A4053SP
FC12011	A4047
FC12011	A4053SP
FC1202	A305F
FC1202	A3726
FC1203	AK570SP
FC1206	A4047
FC1301	A034L
FC1301	A4053SP
FC1301	A5138SP
FC13012	A034L
FC13012	A4053SP
FC13012	A5138SP
FC13013	A034L
FC13013	A4053SP
FC13013	A5138SP
FC1302	A4047
FC1303	A15
FC1306	AS1441SP
FC1310	A23
FC13190	A4023SP
FC13200	A23251SP
FC1501	A4053SP
FC15013	A4053SP
FC1502	A4053SP
FC1503	A7602
FC1504	A093DSP
FC1505	A4054SP
FC1506	A7602
FC1511	A7533C
FC1701	A305F
FC1701	A3726
FC1702	P346P
FC1703	A305F
FC1705	A305F
FC1705	A3726
FC1705	A4047
FC1706	A3726
FC1707	A7533SP
FC1801	A4053SP
FC18012	A4053SP
FC1803	A7533DSP
FC1803	A7533SP
FC1804	A4053SP
FC1805	A1P2299

SAKURA	PARTMO
FC1806	A7602
FC1807	A5368SP
FC1814	A7533DSP
FC1826	A1P2299
FC2204	AS200SP
FC2303	A30SP
FC2303	A30SP
FC2304	A31SP
FC2304	A31SP
FC25060	A243004SP
FC2701	A7602
FC2702	A4053SP
FC27021	A034L
FC27021	A4053SP
FC27021	A5138SP
FC2801	AS201SP
FC2802	A84400SP
FC28040	A84040SP
FC2904	AS200SP
FC29080	AS103SP
FC5101	P3461
FC5103	P346P
FC5104	P346P
FC51041	P346P
FC5105	P3461
FC5106	P346P
FC5107	P596
FC5109	P346P
FC5306	AS1441SP
FC5401	A888
FC5402	A23L39
FC5402	A23L39SP
FC5501	A1P2299
FC5502	A85
FC55021	A614
FC5519	A614
FC5601	A330C
FC5604	A4053SP
FC5604	A4054SP
FC5613	A7813SP
FC5618	A4053SP
FC56251	A7813SP
FC5701	A23
FC5702	A1212SP
FC5704	A243004
FC57041	A243004
FC5705	A1212SP
FC5706	A787
FC57083	A1226LSP
FC5709	A1259SP
FC5715	A1226LSP
FC5720	A23
FC5721	A1212SP
FC5725	A7813SP
FC6203	A243004
FC6203	A243004SP
FC62031	A243004
FC62032	A243004
FC6501	A96
FC6502	A97
FC6503	A96C
FC6504	A97C
FC6801	A1226LSP

SAKURA	PARTMO
FC6801	A33358
FC7101	A243004
FC7103	A1226
FC7104	A8059
FC7301	A97
FC7901	A48MC
FC7903	A33358
FC7933	A588
FC8001	A4047
FC8002	A4053SP
FC80021	A4053SP
FC80022	A4053SP
FC8301	A1894
FC9800	A4618310
FF2018	PFG1104
FS10043	PFG516K
FS1016	PM7680
FS1105	A330C
FS1115	PFG423
FS1134	A243004
FS11650	PFG420
FS1212	A1212SP
FS1410	PFG368
FS1715	PFG335
FS1723	PFG368
FS1804	PFG1104
FS18290	PFG448
FS18291	PFG448
FS19130	PFG391
FS2301	PFG330
FS2810	PFG3191105000
FS3103	PFG7958
FS31140	PFG454
FS8001	PFG1104
FS8001	PFG516K
FS8001	PM707
FS8001	PM707E
FS8002	A91T1
FS8007	PFG1104
FS8903	PFG25121074
H5504	PM9M9740
HC1119	A14302PLUS
HC1902	A354
HC19040	A83910
ME063130	AP5021
O1010	PM53103E
O1011	PM54236E
O1012	PM54236E
O1301	PM1878100752
O13011	PM1878100752
O1303	PM1878100752
O1308	PM1650
O13081	PM1650
O1313	PM7572
O1316	PM1878100752
O1321	PM72281SP
O1323	PM72281SP
O1325	PM1650
O1506	PM9885132652
O1519	PM7572
O1522	PM2240
O1524	PM1878100752
O1525	A1403SP

SAKURA	PARTMO
O1527	PM1650
O1802	PM1878100752
O1803	PM126
O1805	PMUD999
O18051	PMUD999
O1813	PM1878100752
O1902	PM313
O2201	PM3
O2605	PM17
O2611	PM0011843925
O26111	PM0011843925
O2803	PM84001SP
O5001	PM813
O50011	PM813
O5302	PM4031840025
O5311	PP7196
O5401	PM3
O5702	PM343
O57021	PM343
O5703	PM248
O5704	PMX750R
O6503	PM197
S1703660	A58
SF1307	PM1730SP
SF191110	PP201010
SF191130	PP201030
SF19122	PP202030
SF191230	PP202030
SF191330	PP204030
SF27010	PM19624SP
SF57010	PP7751
SF71010	PM19765SP
SF72011	PM7680
SFC130610	ASR45SP
SFC130630	AS1441SP
SFC130630	AS1441SP
SFC190230	A830
SFC1904	A7301DSP
SFC190510	AS1249SP
SFC1912010	A9894DSP
SFC1913010	A830
SFC24030	AS24030SP
SFC260110	AS0015SP
SFC260110	ASV1060SP
SFC2801	AS5850SP
SFC2801	AS5850SP
SFC3101010	AS27177JSP
SFC5003010	AS1282SP
SFC530410	AS5850SP
SFC5306010B	AS0015SP
SFC5401	A1345SP
SFC540210	AS830SP
SFC550430	AS46018SP
SFC550910	AS1003SP
SFC5706	A787
SFC5708	A1226LSP
SFC65020	A5813SP
SFC7301	A5813SP
SFC7907	A7533DSP
SFC791210	ASR90TSP
SFC791230	ASR90TSP
SFC7914030	AS950SP
SFC79160	A9894DSP

SAKURA	PARTMO
SFC792530	AS1441SP
SFC792530V	AS1441SP
SFC792630	AS5850SP
SFC793930	AS88583SP
WC57020	AW2127SP
WC5705	AW5137SP
WC5707	AW2010SP
WC5711	AW2010SP
WC5712	AW2016SP
WC6901	AW2016SP
WC7101	AW2016SP
WC7101	AW2237SP
WC72010	AW475SP
WC7901	AW2010SP
WIX	PARTMO
3	A11
77	AP3129
98	AP121
24006	A70010
24020	AW5137SP
24022	AW5137SP
24023	AW5137SP
24025	AW2010SP
24026	AW5137SP
24029	A70015SP
24030	AW5137SP
24040	AW475SP
24043	PP246
24043	PP246
24050	A91T1
24068	AP31032
24070	AW2010SP
24071	AW5137SP
24073	AW2010SP
24074	AW2016SP
24096	A96
24097	A97
24112	AW2127SP
24113	AW2127SP
24133	PM197
24136	A495SP
24137	A495SP
24142	AW2010SP
24155	PP5092
24196	AW2237SP
24200	AP31026
24313	AP31033
24316	AP43042
24318	AP31037
24347	A48MC
24348	A915
24374	AA5374
24374	AA5374
24428	AW475SP
24429	AW2022SP
24431	AW2022SP
24483	AP31071
24484	AP31043
24488	AP31071
24488	AP31081
24511	AP31071
24520	A15
24542	A3612ASP

WIX	PARTMO
24543	A3612ASP
24557	A3612ASP
24683	AP31060
24684	AP31739
24751	PMX750R
24829	AP31088
24887	AP4M8048
24888	AP4M9335
24902	AP31002
24954	PM343
33002	PFG516K
33010	PM3
33012	PFG516K
33022	PFG1105
33023	PFG1104
33025	PFG516K
33026	PFG516K
33028	PFG1104
33032	PFG516K
33084	PFG805
33085	PFG805
33089	PFG805
33090	PM9760
33095	PFG516K
33097	PFG1105
33103	PFG1163
33107	A15
33108	A1212SP
33109	A23
33109	A23SP
33112	PM28S1Z
33112	PM325
33115	A23SP
33118	A96
33120	A97
33120	A97SP
33121	A96C
33121	A96C
33122	A97C
33123	A1285DSP
33125	A96C
33125	A96C
33128	A4886
33128	A570DSP
33128	AK570SP
33138	A7533DSP
33138	A7533SP
33142	P346P
33160	PFG44781
33161	PFG1195
33166	P346P
33167	PM324
33167	PM324E
33167	PM707
33167	PM707E
33179	PFG1195
33184	A7301DSP
33184	ASR45SP
33185	PP246
33196	P3461
33199	PFG330
33208	PP201010
33208	PP201030

WIX	PARTMO
33209	PP204030
33210	PP202030
33211	AS1282SP
33211	ASV1282SP
33212	PP202030
33215	A1230
33215	AS1230SP
33216	A150F
33216	A150F
33217	A1230
33217	AS1230SP
33218	A30SP
33218	A30SP
33219	A31SP
33219	A31SP
33231	AS1441SP
33232	A1345SP
33232	AS830SP
33235	PFG3191125000
33237	A46SP
33237	A46SP
33237	A888
33242	AS1249SP
33243	PFG7802
33244	AR16SP
33244	AR16SP
33260	PM9885111911
33265	PFG4811
33270	PFG323
33281	A4618310
33282	PM9885111911
33295	PFG872
33296	PFG872
33308	PFG335
33310	PFG1104
33319	PFG423
33336	A46SP
33336	A888
33338	A588
33338	A588SP
33340	A1P2299
33340	A1P2299
33341	A23L39
33341	A23L39SP
33343	A7614SP
33349	PP7751
33352	A1P2299
33352	A1P2299
33353	A43SP
33356	A1P2299
33356	A1P2299
33357	A787
33358	A243004
33358	A33358
33362	A1P2299
33362	A1P2299
33373	A33358
33373	A33358L
33374	A614
33377	A1R0751SP
33377	A1R0751SP
33382	A7602
33384	A85

WIX	PARTMO
33386	A4053SP
33386	A4054SP
33387	PFG44781
33388	A034L
33388	A2863SP
33388	A4053SP
33388	A5138SP
33390	A4047
33391	A305F
33393	A034L
33395	A305F
33395	A3726
33396	A305F
33396	A3726
33396	A3726SP
33397	A305F
33398	A7602
33399	A292
33403	A588SP
33404	A830
33405	A106
33405	A1212SP
33405	A1212SP
33405	ASV1212SP
33406	A1212SP
33406	A1259SP
33407	A1212SP
33407	A1212SP
33411	A1230
33412	AS5850SP
33414	AS1282SP
33415	A1212SP
33415	ASV1212SP
33417	A1205SP
33418	A5813SP
33422	AS1272SP
33423	AS1040SP
33424	PFG7742
33425	PFG25121074
33425	PFG872
33426	AS1282SP
33430	A1212SP
33431	A1212SP
33431	ASV1212SP
33432	A5813SP
33434	A1212SP
33437	PP202030
33439	A1212SP
33441	A1212SP
33441	ASV1212SP
33442	AS3202SP
33443	A1204SP
33446	A1204SP
33446	AS4057SP
33451	PM7680
33452	A1212SP
33453	PFG0120490B
33472	A1226
33472	A243004DSP
33472	A243004DSP
33477	PFG1163
33488	AS1040SP
33494	PFG44781

WIX	PARTMO
33497	PFG1191
33500	PFG44781
33501	PFG805
33505	A56670
33519	A330C
33519	A941C
33519	A941SP
33520	A330C
33525	A56670
33587	A7657
33588	A1218
33588	A7656E
33594	PFG1195
33594	PFG323
33597	PFG368
33604	AS1003SP
33611	A1345SP
33614	AS4057SP
33616	A1CSP
33617	A7301DSP
33618	PFG367
33619	PFG7958
33621	A1212SP
33626	A1R0751SP
33626	A1R0751SP
33628	PP7761
33630	AS5849SP
33634	PP7735
33643	PFG1195
33644	A7773SP
33651	PM7680
33654	A7813SP
33655	PM19915SP
33662	A1218
33671	A26000SP
33674	A614
33680	AS7784D
33682	A7813SP
33690	A7653
33698	A1204SP
33698	AS1282SP
33711	A7766SP
33717	A48MC
33719	PP19684SP
33721	A8059
33742	A4053SP
33744	A7927SP
33745	PP22135
33749	PFG7742
33755	ASR45SP
33755	ASV45SP
33765	A1226ISP
33774	AS46018SP
33775	AS4654SP
33777	A243004SP
33777	A33358
33791	PP202030
33792	PP202030
33793	PP202030
33795	PP201010
33796	PP201010
33796	PP201030
33797	PP204030

WIX	PARTMO
33798	PP204030
33799	PP204030
33812	AS5850SP
33849	PP9924KIT
33937	PP28970
33954	A1894
33956	A7813SP
33962	A9894DSP
33965	AS1003SP
33966	A7813SP
33970	A7301DSP
33972	PF6516K
33975	A7929SPKIT
33991	PP7986
33995	AS24030SP
37005	PM9760
37026	A56670
39021	PM1878100270
39021	PM1878100271
39028	PM9760
39063	A7602
39069	A034L
39069	A4053SP
39069	A5138SP
39090	P596
42015	AP3121
42016	AP3582
42047	AP4M8047
42048	AP4M8048
42069	AP3129
42077	AP3129
42094	AP6261
42097	AP6261
42098	AP121
42103	AP147
42118	AP101234K
42126	AP101246K
42143	AP4041
42159	AP1861
42164	AP3112
42168	AP35644
42173	AP1368
42188	AP63680
42208	AP110558
42209	AP106775
42209	AP110558
42216	AP2216
42217	AP4416
42222	AP101222K
42234	AP101234K
42253	AP182028
42254	AP137640
42255	AP7N1225
42276	AP101275K
42279	AP3517
42329	APC301251
42333	AP3179
42334	AP4M9334
42335	AP4M9335
42338	AP101246K
42346	AP2300
42347	AP531
42349	AP626

WIX	PARTMO
42351	AP3570
42370	AP3709
42378	AP4M9378
42379	AP4M9379
42385	AP3557
42422	APCA502
42423	APCA502SY
42467	AP87658
42472	AP35591
42472	AP35665
42476	AP3134
42479	AP3134
42484	AP35736
42486	AP35606
42497	AP95600906
42518	AP2360
42520	AP812105
42521	AP114215145
42522	AP25867
42543	AP4129908
42551	AP3565
42594	AP127312
42605	AP3563
42606	AP31542
42608	AP2291
42609	AP4091
42618	AP117797
42635	AP57MD21
42636	AP57MD31
42700	AP95600906
42711	AP186
42729	AP35433
42737	AP31828
42740	AP31588
42748	AP58010
42759	AP2520
42759	AP2520H
42768	AP4000
42769	AP2489
42776	AP2425
42784	AP2482
42793	AP3557
42796	AP7242
42797	AP31678
42806	AP10903
42825	AP3140
42826	AP3450
42827	AP2021
42831	AP3196
42834	AP3108
42875	AP78605
42885	AP31834
42899	AP31511
42912	AP4337
42924	AP4129908
42926	AP101246K
42961	AP57MD33
42966	AP117797
42971	AP3539
45001	AP1330
46006	AP3170
46012	AP3129
46015	AP132

WIX	PARTMO
46017	AP3135
46019	AP323
46026	AP3137
46027	AP31544
46028	AP3138
46040	AP126
46040	AP2300
46043	AP3179
46046	AP121
46057	AP3118
46065	AP121
46066	AP121
46077	AP1323
46081	AP1323
46082	AP31511
46083	AP3123
46097	AP31559
46097	AP3509
46104	AP1375
46105	AP31521
46109	AP3136
46116	AP1312
46117	AP1339
46119	AP603A
46126	AP3562
46147	AP31550
46156	AP1330
46160	AP147
46174	AP1305
46179	AP3924
46183	AP3124
46186	AP561
46193	AP3176
46195	AP31828
46207	AP3178
46213	AP3574
46215	AP3128
46221	AP35645
46229	AP31555
46234	AP3924
46235	AP142
46240	AP35815
46242	AP3142
46243	AP31550
46244	AP3129
46253	AP1365
46259	AP3500
46264	AP3932
46265	APL300
46271	AP31564
46273	AP3133
46280	AP2576
46281	AP2576
46281	AP2577
46284	AP16546
46288	AP3170
46289	AP6261
46308	AP31531
46314	AP2805
46318	AP3567
46320	AP35644
46322	AP3125
46325	AP2521

WIX	PARTMO
46327	AP3527
46340	APSL40A
46353	AP3936
46357	AP2712
46357	AP2712A
46358	AP3533
46360	AP101275K
46363	AP2712
46388	AP1292
46389	AP4000
46390	AP35793
46418	AP3515
46429	AP3501
46433	AP2863
46438	AP3716
46440	AP3707
46441	AP3707
46443	AP3139
46466	APSL5013Z40A
46486	AP561
46489	AP3988
46506	AP2761
46525	APC203252SY
46530	AP46530
46531	AP46531
46536	AP2761
46541	AP41702
46544	AP5021
46545	AP51250
46554	APC203252
46556	AP3518
46557	AP2712
46560	AP87658
46562	AP3544P
46567	AP2360
46568	AP2741
46569	AP3545
46569	AP3545
46600	AP4129907
46608	AP2677
46609	AP2677
46614	A111
46617	AP524344
46628	AP3518SY
46640	AP821884
46646	AP31653
46647	AP17845
46652	AP3542
46664	AP3548
46665	AP3722
46671	AP3542
46672	AP3543
46681	AP25867SY
46682	AP3138
46701	AP3736
46702	AP3737
46712	AP2688
46713	AP2621
46722	AP2688
46723	AP2621
46744	AP2690
46745	AP2654
46771	AP3870SY

WIX	PARTMO
46774	AP127312
46775	AP127313
46776	AP14210
46777	AP14220
46779	AP87657
46804	AP35755
46834	AP31628
46836	AP3920
46837	AP3921
46839	AP57MD21
46843	AP3539
46870	AP4636
46871	AP4637
46876	AP2660
46882	AP2680
46883	AP2705
46885	AP2632
46888	AP3116
46932	AP2877S
46983	AP2654SY
47028	AP2712
47029	AP2825
49008	AP311001
49010	AP31753
49016	AP35783
49017	AP35893
49018	AP31795
49022	AP31100
49030	AP31753
49038	AP31461
49049	AP35932
49064	AP3571
49069	AP29400
49070	AP3144
49073	AP31944
49082	AP31036
49088	AP4862
49089	AP4863
49099	APC203252SY
49102	AP3191
49104	AP31801
49104	AP35644
49113	AP3122
49126	AP4642
49131	APC20500
49132	APC20500SY
49134	AP05113
49143	AP2825
49145	AP35602
49175	AP35961
49180	AP3112
49186	AP3538
49189	AP80006SY
49189	AP80006SY
49190	AP80006
49190	KITAP80006 / AP80006SY
49191	AP31697
49192	AP35741
49210	AP3145
49212	AP35939
49225	AP3132
49247	AP31899

WIX	PARTMO
49262	AP31035
49344	AP355344
49368	AP31029
49400	AP31744
49430	AP35898
49480	AP31832
49522	AP3513
49558	AP84457
49576	AP87658
49590	AP350990
49604	AP35844
49634	AP31942
49640	AP3111
49670	AP31900
49782	APC23610SY
49783	APC23610
49800	AP31928
49876	AP3570
49893	AP23603
49961	AP9961
49993	AP3544P
51004	PM174
51008	PM174
51010	PM3
51015	A1
51015	A1SP
51016	A1
51016	A1SP
51021	PM17
51026	PM3
51031	PM3
51034	A178PLUS
51036	A4011
51037	A111
51040	A111
51040	A43S
51046	A11
51046	A12
51046	A12
51050	A50
51053	A48SP
51060	A1428
51061	A11
51061	A1428
51063	A11
51064	A52
51064	A53PLUS
51065	A14478PLUS
51067	A092SP
51067	A28SP
51068	A20
51068	A20PLUS
51069	A11
51069	A12
51071	PM210
51076	PM210
51077	PM210
51080	PM210
51083	A73
51083	A4056
51085	A20
51085	A20PLUS
51085	AR1218
51088	A178PLUS

WIX	PARTMO
51091	A142SP
51092	PM192
51094	A142SP
51099	PM313
51101	PM17
51115	PM248
51130	PM197
51132	PFG1105
51133	PM197
51136	PM197
51145	PP40425
51158	A48SP
51158	A7031
51163	PM9M9740
51180	PM192
51182	A091AE
51187	PP7196
51188	PM813
51190	A4011
51192	AS1040SP
51199	A70015SP
51201	PM1878100270
51203	A70015SP
51205	A70015SP
51214	A372
51215	A14302PLUS
51223	PP27908
51243	A26SP
51243	A26SP
51258	A33
51261	A54SP
51268	A9N5570SP
51270	PM245
51271	PM245
51275	A48SP
51282	PM1878100752
51288	A14302PLUS
51288	A18
51288	A18PLUS
51289	PP50361
51298	A48SP
51302	PM126
51307	A20
51307	A20PLUS
51315	A1406
51315	A14476
51317	A20
51317	A20PLUS
51318	A73
51324	A091AE
51324	A4046
51330	A350
51334	A323
51334	A52
51334	A53PLUS
51335	AR46
51338	A323
51339	A20
51339	A20PLUS
51339	AR4M
51342	A178PLUS
51342	A372
51344	A73

WIX	PARTMO
51344	A73PLUS
51345	A113
51345	A372
51347	A73
51348	A14302PLUS
51348	A14302PLUS
51348	A223
51349	A7223SP
51356	A1402
51356	A1402PLUS
51357	A58
51357	A58PLUS
51357	A58T
51358	A58
51358	A58PLUS
51358	A58T
51361	A113
51362	A20
51362	A20PLUS
51363	PMX1878100501
51364	A113
51365	A58
51365	A58PLUS
51365	A58T
51366	A14476
51367	A113
51368	A91480
51369	A7029SP
51369	A7029SP
51369	A7029SP
51372	A329
51374	A20
51374	A20PLUS
51376	A9N6007SP
51377	A777CSP
51377	A777SP
51380	A4044
51380	A73
51381	A4044
51381	A52
51381	A53PLUS
51386	A2863B
51386	A350
51386	A4731SP
51386	A4731SP
51387	A291
51390	AR9
51393	A178PLUS
51394	A1406
51394	A1406PLUS
51394	A14476
51394	A14476PLUS
51395	A14476
51395	A14476PLUS
51396	A1406
51396	A1406PLUS
51396	A14476
51411	A22SP
51411	A267
51413	A70015SP
51414	A777CSP
51414	A777SP
51429	A325SP

WIX	PARTMO
51431	A232SP
51444	A7223SP
51453	A54SP
51459	AR17
51475	PM174
51500	PM17
51502	PM17
51503	PM17
51515	A1
51515	A1SP
51516	A372
51522	A1432
51523	A2863SP
51523	A2863SP
51523	A2863SP
51525	A1
51525	A1SP
51551	A83910
51552	A83910
51568	A73
51596	A447
51599	PM53103E
51599	PM54236E
51601	A267
51602	A427SP
51604	A339SP
51607	A339SP
51613	PM248
51617	A11
51618	A33
51625	A14476
51626	A4044
51626	A4044
51640	PM1878100752
51641	A7018
51642	A9003SP
51649	A205SP
51659	A7158SP
51660	A7685SP
51669	A116SP
51670	A116SP
51671	A116CSP
51673	A7041SP
51673	A7041SP
51673	A205SP
51674	A1403SP
51675	A7028SP
51681	A777CSP
51681	A777SP
51701	AR17
51712	A354
51714	A22SP
51714	A267
51725	A4048SP
51726	A350
51727	PM0011843925
51734	A3786SP
51734	A3786SP
51742	A134
51747	A309SP
51748	A3000SP
51748	A3000SP
51748	A3000SP
51749	A777CSP

WIX	PARTMO
51749	A777SP
51750	PMX750R
51751	PMX750R
51752	PMX750R
51753	PMX750R
51754	A129SP
51758	AR29SP
51759	A91T1
51759	AR29SP
51761	A116CSP
51762	A372
51764	A178PLUS
51772	A840SP
51772	A840SP
51773	AR17
51775	A1
51775	A1SP
51776	A343
51777	A343
51778	A4863
51784	A299E
51785	A14302PLUS
51785	A14302PLUS
51785	A223
51785	A4041
51789	A299E
51789	APL300
51791	A67SP
51792	A69SP
51794	A84SP
51797	A7031
51797	A840SP
51798	A9N6007SP
51799	A408SP
51803	A48SP
51806	A1
51808	A129SP
51809	A7095
51810	A010
51810	A105SP
51811	A116SP
51811	A3612ASP
51812	A116SP
51813	A116SP
51820	A48SP
51820	A840SP
51825	A349SP
51825	A840SP
51832	A349SP
51833	A7041SP
51833	A205SP
51838	PP8088
51839	A4052SP
51848	A69SP
51861	A91T1
51861	AR29SP
51869	A116SP
51870	A116SP
51873	A116SP
51900	PM343
51954	PM343
51955	PM343
51970	A116SP

WIX	PARTMO
51970	A3612ASP
51971	A495SP
51999	A4049SP
57014	A1480
57027	A16242SP
57037	A7898SP
57041	PP7406
57051	A9035SP
57060	A160
57060	A160PLUS
57061	PP57061
57064	PP4024
57076	A7306SP
57080	A7105SP
57080	A7105SP
57082	PP8088
57083	PP15466
57083	PP4780
57085	A178PLUS
57085	A18
57085	A18PLUS
57092	A323
57112	PMUD999
57143	A9797PLUS
57144	PP79744
57145	A1406
57145	A1406PLUS
57145	A14476
57173	PP31060
57181	A14302PLUS
57182	A7177SP
57187	PP7399
57190	A7105SP
57203	PP6
57207	A3603
57207	A3603PLUS
57210	PP5562
57213	PP7230SP
57214	PP7199
57215	PP9452
57243	A7125
57251	A2700SP
57254	A7029SP
57254	A7029SP
57254	A7029SP
57262	PP15562
57299	A7174SP
57301	A372
57356	A1402
57356	A1402PLUS
57382	A7375SP
57400	A1480
57411	A7144SP
57488	A7898SP
57500	A3000SP
57502	A52041SP
57512	PP358
57521	A2700SP
57526	PP79744
57561	A15403
57580	A7133
57609	PM4031840025
57620	A339SP

WIX	PARTMO
57669	A7506SP
57674	PP85674
57708	A7503SP
57712	A58
57712	A58PLUS
57712	A58T
57744	A9025SP
57745	A9080SP
57746	A9080SP
57748	A9080SP
57810	A010
57810	A105SP
57899	A329
57909	PP7505
57911	PM9885132652
59035	A232SP
59096	PM4031840025
59097	PM17
59098	PM4031840025
59145	PM9885132652
59148	A4052SP
59152	A205SP
59165	PM1650
59179	A7018
59191	A1480
59209	A142SP
59216	A010
59216	A105SP
59221	A73
59222	A092SP
59226	A14302PLUS
59230	PM7572
59237	A7029SP
59237	A7029SP
59240	A4052SP
59240	A4052SP
59243	A1403SP
59244	A7028SP
59252	A7105SP
71716	AP35815
512518	A20
512518	A20PLUS
524043	PP246
524071	AW5137SP
524073	AW2010SP
524113	AW2127SP
524196	AW2237SP
524428	AW475SP
524429	AW2022SP
524887	AP4M8048
524888	AP4M9335
533109	A23
533109	A23SP
533118	A96
533120	A97
533120	A97SP
533216	A150F
533216	A150F
533218	A30SP
533218	A30SP
533219	A31SP
533219	A31SP
533336	A46SP

WIX	PARTMO
533336	A588
533336	A588SP
533337	A588
533341	A23L39
533341	A23L39SP
533352	A1P2299
533352	A1P2299
533384	A85
533399	A292
533404	A830
533442	A5813SP
533621	A1212SP
533644	A7773SP
533654	A7813SP
533698	A1204SP
533711	A7766SP
533721	A8059
533965	AS1003SP
533970	A7301DSP
542118	AP101234K
542159	AP1861
542217	AP4416
542255	AP7N1225
542338	AP101246K
542346	AP2300
542479	AP3134
542497	AP95600906
542518	AP2360
542520	AP812105
542521	AP114215145
542543	AP4129908
542608	AP2291
542609	AP4091
542618	AP117797
542971	AP3539
546006	AP3170
546027	AP31544
546077	AP1323
546109	AP3136
546174	AP1305
546235	AP142
546243	AP31550
546244	AP3129
546284	AP16546
546314	AP2805
546353	AP3936
546466	APSL5013Z40A
546525	APC203252SY
546530	AP46530
546531	AP46531
546536	AP2761
546560	AP87658
546562	AP3544P
546568	AP2741
546569	AP3545
546608	AP2677
546609	AP2677
546617	AP524344
546628	AP3518SY
546647	AP17845
546652	AP3542
546664	AP3548
546665	AP3722

WIX	PARTMO
546671	AP3542
546681	AP25867SY
546701	AP3736
546722	AP2688
546723	AP2621
546744	AP2690
546745	AP2654
546774	AP127312
546775	AP127313
546776	AP14210
546777	AP14220
546779	AP87657
546843	AP3539
546870	AP4636
546876	AP2660
546885	AP2632
546932	AP2877S
546983	AP2654SY
549088	AP4862
551010	PM3
551067	A092SP
551094	A142SP
551229	A70015SP
551261	A54SP
551268	A9N5570SP
551289	PP50361
551312	A178PLUS
551324	A091AE
551338	A73
551374	A14302PLUS
551394	A14476
551394	A14476PLUS
551396	A1406
551396	A14476
551522	A1432
551607	A339SP
551626	A73
551726	A350
551748	A3000SP
551748	A3000SP
551749	A777CSP
551749	A777SP
551750	PMX750R
551778	A4863
551784	A299E
551791	A67SP
551792	A69SP
551808	A129SP
551954	PM343
551970	A116SP
557080	A7105SP
557085	A178PLUS
557210	PP5562
557400	A1480
2030P	P346P
24071MP	AW5137SP
24073MP	AW2010SP
275P	PM28S1Z
318P	A20
318P	A20PLUS
318P	AR1218
319P	A20
319P	A20PLUS

WIX	PARTMO
319P	AR1218
322P	A20
322P	A20PLUS
322P	AR1218
33022MP	PFG1105
33032MP	PFG516K
33097MP	PFG1105
330P	A20
330P	A20PLUS
330P	AR1218
33109MP	A23
33109MP	A23SP
33118MP	A96
33120MP	A97
33120MP	A97SP
33121MP	A96C
33121MP	A96C
33122MP	A97C
33166MP	P346P
33167E	PM707
33167E	PM707E
33167FE	PM324
33167FE	PM324E
33196E	P3461
33216MP	A150F
33217MP	A1230
33218MP	A30SP
33218MP	A30SP
33219MP	A31SP
33219MP	A31SP
33282x	PM988511911
33296MP	PFG872
33336MP	A46SP
33336MP	A888
33341MP	A23L39
33341MP	A23L39SP
33352MP	A1P2299
33352MP	A1P2299
33357MP	A787
33358E	A33358
33358MP	A33358
33358SE	A243004
33384MP	A85
33390MP	A4047
333P	A20
333P	A20PLUS
333P	AR1218
33403MP	A588SP
33405MP	A1212SP
33405MP	ASV1212SP
33406MP	A1259SP
33472MP	A1226
33477MP	PFG1163
33585XE	PP7777SP
335P	A18
335P	A18PLUS
33604XE	AS1003SP
33626MP	A1R0751SP
33651MP	PM7680
33651XE	PM19624SP
33690E	A7653
336P	A243004
339P	A1

CRUCE DE REFERENCIAS

WIX	PARTMO
3405MP	A1212SP
342P	A20
342P	A20PLUS
342P	AR1218
345P	A20
345P	A20PLUS
345P	AR1218
350P	A20
350P	A20PLUS
350P	AR1218
42098MP	AP121
42208E	AP110558
42334NP	AP4M9334
42608E	AP2291
42966E	AP117797
46040MP	AP126
46117MP	AP1339
46126MP	AP3562
46174MP	AP1305
46429P	AP3501
46433P	AP2863
46554E	APC203252
46556NP	AP3518
46744P	AP2690
46836E	AP3920
46843NP	AP3539
46871P	AP4637
48205BR	AP2425
49088P	AP4862
51021E	PM17
51036MP	A4011
51036XP	A4011
51040MP	A111
51040XP	A111
51040XP	A43S
51060MP	A1428
51060XP	A1428
51061MP	A11
51061R	A11
51068MP	A20
51068MP	A20PLUS
51069MP	A11
51069MP	A12
51085MP	A20
51085MP	A20PLUS
51085MP	AR1218
51133LUB	PM197
51133MP	PM197
51136LUB	PM197
5113MP	PM197
51176LUB	PM197
51243MP	A26SP
51243MP	A26SP
51268MP	A9N5570SP
51334MP	A323
51334MP	A52
51334MP	A53PLUS
51334XP	A323PLUS
51334XP	A53PLUS
51348MP	A14302PLUS
51348XP	A14302PLUS
51348XP	A223
51356XP	A73

WIX	PARTMO
51356XP	A73PLUS
51365XP	A58
51365XP	A58PLUS
51365XP	A58T
51372MP	A329
51372XP	A329
51394XP	A14476
51394XP	A14476PLUS
51515MP	A1
51515MP	A1SP
51515XP	A1
51515XP	A1SP
51516MP	A372
51522MP	A1432
51522XP	A1432
51551MP	A83910
51599KIT	PM54236E
51602MP	A427SP
51607MP	A339SP
51669XD	A116SP
51734MP	A3786SP
51734MP	A3786SP
51742MP	A134
51748MP	A3000SP
51748MP	A3000SP
51748XD	A3000SP
51749MP	A777CSP
51749MP	A777SP
51751MP	PMX750R
51784MP	A299E
51789MP	A299E
51791MP	A67SP
51792MP	A69SP
51794MP	A84SP
51799MP	A408SP
51810XE	A105SP
51820E	A840SP
51945MP	PM343
51954MP	PM343
51970MP	A116SP
51970MP	A3612ASP
51970XD	A3612ASP
51971EC	A495SP
51971MP	A495SP
51971XD	A495SP
533604XE	AS1003SP
533651XE	PM7680
57060XP	A160
57060XP	A160PLUS
57064XP	PP4024
57082XP	PP8088
57145XP	A1406
57145XP	A1406PLUS
57203XP	PP6
57356XP	A1402
57356XP	A1402PLUS
57609E	PM4031840025
57620MP	A339SP
57744XD	A9025SP
57745XD	A9080SP
57746XD	A9080SP
5FP	PM17
7006S	PM126

WIX	PARTMO
7143P	PM707
7143P	PM707E
7146P	PM313
7162P	PM813
901P	PM248
911AP	PM126
911P	PM126
915P	PM126
917P	A14302PLUS
918P	PM126
919P	A14302PLUS
92038E	PP9452
92040E	PP7199
92095E	A7898SP
92100E	PM4031840025
92134E	PM9M9740
923P	PM343
93103E	APC20500SY
93104E	APC20500
93150E	AP9961
93160E	AP3838
93215E	AP3921
93241E	APC23610
93326E	AP3544P
93347E	APCA502
93348E	AP87658
93353E	APC203252SY
935P	PM192
93P	PM197
95021E	PP7735
95022E	PP7761
95032E	A1894
95037E	A8059
95041E	A7813SP
95133E	PM325
A101	AP4337
A116	AP2291
A127	APCA502
A146	AP106775
A152	APC203252
A159	AP4129908
A4930	AP4959
A67	AP95600906
A85	AP110558
AK119	AP101246K
AK120	AP101275K
AK121	AP101222K
CA415	A20
CA415	A20PLUS
CA415	AR1218
CR522	P346P
CW10	PM3
CW1107MP	A15
CW1108MP	A15
CW1109MP	A23
CW1109MP	A23SP
CW1172MP	P346P
CW1173MP	PM707
CW1173MP	PM707E
CW133MP	PM197
CW133MPWP	PM197
CW133MPWP	PM197
CW133P	PM197

WIX	PARTMO
CW136MP	PM197
CW1551MP	A83910
CW1551P	A83910
CW188MP	PM813
CW203MP	PM197
CW213MP	PM17
CW218MP	A30SP
CW218MP	A30SP
CW219MP	A31SP
CW219MP	A31SP
CW239M	PM17
CW243MP	A26SP
CW243MP	A26SP
CW244MP	AR16SP
CW244MP	AR16SP
CW270M	PM245
CW270MP	PM245
CW411MP	A267
CW453MP	A54SP
CW475MP	PM174
CW500	PM17
CW750M	PMX750R
CW750MLWP	PMX750R
CW750MS	PMX750R
CW750MSWP	PMX750R
CW954MP	PM343
CW954MPWP	PM343
CW99MP	PM313
DT1222	AP101222K
DT1234	AP101234K
DT1246	AP101246K
DT1275	AP101275K
DT370	AP3709
DT8047	AP4M8047
DT8048	AP4M8048
DT9334	AP4M9334
DT9335	AP4M9335
DT9378	AP4M9378
DT9379	AP4M9379
DT94	AP6261
F24073	AW2010SP
F24074	AW2016SP
F33118	A96
F33121	A96C
F33121	A96C
F33122	A97C
F33166	P346P
F33196	P3461
F33210	PP202030
F33216	A150F
F33216	A150F
F33218	A30SP
F33218	A30SP
F33219	A31SP
F33219	A31SP
F33281	A4618310
F33341	A23L39
F33341	A23L39SP
F33352	A1P2299
F33353	A43SP
F33358	A243004
F33358	A243004SP
F33384	A85

WIX	PARTMO
F33393	A034L
F42097	AP6261
F42209	AP106775
F42222	AP101222K
F42276	AP101275K
F42378	AP4M9378
F42379	AP4M9379
F42636	AP57MD31
F42907	APR9
F42961	AP57MD33
F46015	AP132
F46230	APR12
F46280	AP2576
F46466	APSL5013Z40A
F46531	AP46531
F51015	A1
F51015	A1SP
F51036	A4011
F51040	A111
F51040	A43S
F51068	A20
F51068	A20PLUS
F51099	PM313
F51243	A26SP
F51243	A26SP
F51258	A33
F51261	A54SP
F51268	A9N5570SP
F51342	A178PLUS
F51344	A73
F51344	A73PLUS
F51361	A113
F51374	A4041
F51381	A323
F51381	A323PLUS
F51381	AR9
F51516	A372
F51602	A427SP
F51607	A339SP
F51613	PM248
F51626	A4044
F51671	A116CSP
F51742	A134
F51749	A777SP
F51758	AR29SP
F51791	A67SP
F51792	A69SP
F51794	A84SP
F51798	A9N6007SP
F51870	A116SP
F51954	PM343
FV33666	P596
FV51339	AR4M
FV51372	A329
GF2	A70010
GF3347	A48MC
MA1505	AP1298
MA1505	AP6293
MA1509	AP17308
P15P	A1
P15P	A1SP
PC10	PM3
PC10FP	PM3

WIX	PARTMO
PC15	A1
PC15	A1SP
PC15P	A1
PC15P	A1SP
PC215	A1
PC300P	PM126
PC302P	PM126
PC31	PM3
PC317P	A113
PC318P	A372
PC319P	A20
PC319P	A20PLUS
PC319P	AR1218
PC4F	PM174
PC4FP	PM174
PC500	PM17
PC500P	PM17
PC50P	A50
PC57P	A11
PC57P	A12
PC58P	A33
PC5F	PM17
PC60	A11
PC60P	A11
PC70	PM210
PC70P	PM210
PC750P	PMX750R
PC76N	PM210
PC76NP	PM210
PC80N	PM210
PC80NP	PM210
PC92P	PM192
SA10009	AP4986
SF10005	PM19765SP
SF10024	A1226
SL10106	A7685SP
V33358	A33358
V51050	A50
V51825	A349SP
W24043	PP246
W33166	P346P
W46525	APC203252SY
W46836	AP3920
W48210BR	AP5628
W48915BR	AP5627
WA10001	AP49064
WA10009	AP4986
WA10048	AP31992
WA10085	AP31500
WA10107	A9080SP
WA10229	AP78020
WA10230	AP78090
WA10232	AP1330E
WA10234	AP1325
WA10235	AP17871SY
WA10335	AP31980
WA10340	AP48772
WA10395	AP311019
WA10398	AP4971
WA10408	AP31962
WA10420	AP311033
WA10509	AP17308
WA10770	AP311020

WIX	PARTMO
WA10771	AP99727
WA10835	AP35645
WA1512	AP5627
WA1513	AP5628
WA6008	AP323
WA6047	AP31555
WA6070	AP1908233
WA6081	AP16546
WA6104	AP101222K
WA6105	AP101246K
WA6108	AP3932
WA6134	AP54100
WA6343	AP3570
WA6371	AP31622
WA6426	AP626
WA6462	AP3544P
WA6505	AP1861
WA6506	AP410
WA6534	AP142
WA6570	AP4001
WA6579	AP3193
WA6648	AP67030
WA6688	AP35607
WA6984	AP31035
WA9457	AP3561
WA9464	AP1312
WA9481	AP31624
WA9520	AP3570
WA9557	AP35247
WA9563	AP35750
WA9569	AP3561
WA9581	AP3144
WA9640	AP3120
WA9644	APC010
WA9655	AP35887
WA9670	AP31963
WA9672	AP3146
WA9710	AP3145
WA9721	AP35781
WA9733	AP31820
WA9754	AP35886
WF10005	PM19765SP
WF10006	AS46018SP
WF10012	AS1441SP
WF10016	A7301DSP
WF10024	A1226
WF10024	A243004DSP
WF10024	A243004DSP
WF10024	A33358
WF10045	A5813SP
WF10051	A787
WF10064	A1212SP
WF10064	ASV1212SP
WF10078	AS46018SP
WF10103	PP9908KIT
WF10149	PP7978
WF10201	PP202030
WF10212	A1212SP
WF10213	A830
WF10226	PP71044
WF10231	PP7444
WF10249	PP46135
WF10378	PP11690SP

WIX	PARTMO
WF10452	PM1878100270
WF32	PF6516K
WF42	PM210
WF8018	P346P
WF8020	P3461
WF8034	AP323
WF8034	PF63191125000
WF8042	A1226LSP
WF8046	PF67958
WF8058	A4886
WF8059	A093DSP
WF8061	A7533DSP
WF8063	A7533SP
WF8069	PF61105
WF8103	PF63191125000
WF8110	A305F
WF8121	A11213DSP
WF8155	PM324
WF8155	PM324E
WF8156	PM324
WF8156	PM324E
WF8165	PF625121074
WF8172	A4053SP
WF8181	A1226
WF8395	AS201SP
WF8429	PP7355
WF8439	PF6448
WL10001	A14616
WL10007	PP88580
WL10013	A113
WL10024	PP6013Z
WL10031	A28SP
WL10047	PP7494
WL10068	A14302PLUS
WL10071	A83910
WL10087	A8720L
WL10106	A7685SP
WL10107	A9080SP
WL10108	A40053SP
WL10231	A7144SP
WL10259	A4271SP
WL10263	A1480
WL10283	PP95785
WL10286	PP80215
WL10370	PP7508
WL10412	A52041SP
WL7004	PP50361
WL7058	PM126
WL7061	PP7196
WL7065	A50
WL7070	A178PLUS
WL7077	A372
WL7096	A1
WL7098	A20
WL7098	A20PLUS
WL7107	A52
WL7113	A7028SP
WL7134	A1402
WL7143	A113
WL7154	A092SP
WL7160	A232SP
WL7171	A4044
WL7172	A14302PLUS

WIX	PARTMO
WL7174	A91480
WL7175	A7029SP
WL7175	A7029SP
WL7176	A091AE
WL7177	A1406
WL7177	A14476
WL7199	A7028SP
WL7200	A58
WL7214	A329
WL7248	A4044
WL7302	PP2200C
WL7304	PP40425
WL7307	A2863B
WL7307	A4731SP
WL7410	PP80125
WL7414	AL106
WL7418	PM2200
WL7418	PP2200
WL7424	PP62442
WL7443	A329
WL7462	PP27401
WL7477	PP3C30A
WL7503	A14302PLUS
WL7508	PP16328
WP10179	AP31097
WP10265	AP43100
WP10319	AP31043
WP10320	AP31138
WP10322	AP31138
WP2020	AP31019
WP6984	AP31035
WP6985	AP31035
WP6990	AP31090
WP9344	AP31055
WP9344	AP31743
WP9357	AP71191



ES JUSTO

LO QUE NECESITAS

CARTA DE GARANTIA



**SOLUCIONES EN FILTRACIÓN
PARA TRANSPORTE MEDIANO**

GARANTÍA[®]

PARTMO

1. Generalidades:

Los filtros Partmo son fabricados con los más severos controles de calidad, no obstante, cualquier filtro encontrado defectuoso por fabricación, material o diseño será reemplazado sin costo, incluyendo gastos de envío.

La garantía es válida a partir de la entrega del filtro al cliente, y el término será de un año. Esta garantía es válida en los territorios en los que el producto Partmo sea comercializado. La responsabilidad de Partmo se limita al cumplimiento de la garantía descrita en este numeral.

La garantía contenida en este documento es la única reconocida por Filtros Partmo S.A.S. como respaldo a sus productos, Filtros Partmo S.A.S. no reconoce ninguna otra garantía expresa o implícita.

2. Procedimiento:

El cliente estará obligado a informar del daño que tiene el producto y ponerlo a disposición de Filtros Partmo S.A.S. en los puntos de atención dispuestos para el efecto por parte de la fuerza de venta del producto. Deberá indicar la fecha de compra o de la celebración del contrato correspondiente. En caso de considerar improcedente la solicitud de garantía, Partmo lo informará por escrito.

3. En caso de afectación a otros equipos:

Partmo pone a disposición del cliente el siguiente mecanismo para recepción reclamación por afectación a otros equipos o componentes:

- Si el cliente considera que un filtro al que no le aplica alguna de las causales del numeral anterior causó la afectación y está interesado en llegar a un acuerdo, puede enviar a Partmo información acerca de la falla y prueba de compra del producto. En caso de ser necesario Partmo solicitará información adicional para evaluar la solicitud.
- Partmo podrá verificar la falla acudiendo físicamente o solicitando el envío de las piezas a las oficinas centrales o laboratorios para determinar la situación que dio lugar a la falla así como verificar las condiciones (utilización, vida útil remanente, etc.) del equipo previas a la falla.
- En caso que Partmo lo considere pertinente, podrá ofrecer, en el marco de un contrato de transacción, el pago de una suma que dé por terminada la controversia, sin que tal oferta pueda ser interpretada como aceptación de responsabilidad por parte de Partmo.
- La responsabilidad de Partmo no será superior al valor de adquisición efectiva del Equipo (en valores nominales, no actualizables), menos el porcentaje de utilización del mismo al momento de instalación del filtro Partmo.

4. Exoneración de responsabilidad de Garantía:

Filtros Partmo S.A.S. no será responsable de las fallas resultantes de una instalación que no hubiese atendido a las instrucciones por tipo de filtro, uso o mantenimiento indicados, o que se produzca por el hecho de un tercero, por alteración, uso indebido, negligencia del cliente, caso fortuito o fuerza mayor. Filtros Partmo S.A.S. no es responsable de los daños que se causen por tiempos de inactividad del componente o motor.

La garantía no será aplicable respecto de productos Partmo cuyo término de Garantía haya finalizado. La garantía no incluye aspectos adicionales tales como gastos de viaje, inactividad, lucro cesante u otros daños accidentales o consecuenciales.





FILTROS
partmo

60 años



Seguiremos recorriendo

millones de Kilómetros más

junto con nuestros aliados estratégicos





60 años

Colombia:

Dirección: Calle 1 #3-15, Km 7

Vía Palenque -Café Madrid Parque Industrial 2

Ciudad: Bucaramanga

Teléfono: + 57 315 671 4609

Teléfono: + 57 312 362 5869

Centroamérica y Caribe:

Teléfono: + 57 323 253 0681

Servicio al Cliente:  (+57) 317 645 6045

(+57) 607 644 3775 - 01 8000 978 203

Encuétranos como
Filtros Partmo /  /  /  /  /

www.partmo.com



ES JUSTO
LO QUE NECESITAS



CIAL-GU-02 8/31/2023



**SOLUCIONES EN FILTRACIÓN
PARA TRANSPORTE MEDIANO**

Encuétranos como **Filtros Partmo** / f / @ / in / ▶ /

partmo.com



CO-SC-CER896120